



# LOWER MINNESOTA RIVER WATERSHED DISTRICT

## Executive Summary for Action

Lower Minnesota River Watershed District Board of Managers Meeting  
Wednesday, April 17, 2024

### **Agenda Item**

#### **Item 9. B. – Dredge Management**

#### **Prepared By**

Linda Loomis, Administrator

#### **Summary**

##### Vernon Avenue Improvement Project

The LMRWD has been working on improvements to Vernon Avenue. The project has gone through the investigation, design and permitting process. It is now ready to go out for bids. Staff has prepared an update on this project for the Board to review.

The engineer's estimate of the cost to construct the project exceeds LMRWD's ability to pay for the project. We had anticipated that we would be able to provide guidance to the Board with options for financing the project, however, we have not been able to get answers to certain questions from the Board of Water and Soil Resources.

Shannon Sweeney, from David Drown Associates, is working on financing options and has engaged Taft law firm as bond counsel. Once we have some answers from BWSR, Mr. Sweeney will be able to provide the Board with options and recommendations as to how to finance the project.

In the meantime, the Board should consider authorizing moving ahead with preparations to go out for bids.

#### **Attachments**

Technical Memorandum – Vernon Avenue Improvements – Project Summary and Bidding Instructions, dated April 10, 2024

#### **Recommended Action**

Motion to conditionally approve to advertise for bids with modifications to the dates in the attachments one the funding strategy is approved.

# Technical Memorandum



**To:** Linda Loomis, Administrator  
Lower Minnesota River Watershed District

**From:** Hannah LeClaire, PE, Project Manager  
Della Schall Young, CPESC, PMP, CTF, Principal Scientist

**Date:** April 10, 2024

**Re:** Vernon Avenue Improvements—Project Summary and Bidding Instructions

---

This memorandum summarizes the work completed for the Vernon Avenue Improvements Project (“Project”) and the next steps to execute bidding and project award. The Project began in January 2023. The timeline shown in Table 1 summarizes the work completed thus far.

*Table 1. Project Timeline*

January 2023	Project workplan approved by the LMRWD Board of Managers
March 2023	Project jointly awarded to Bolton & Menk Inc. (BMI, design) and ISG (environmental permitting)
May 2023	Cultural Resources Review awarded to the 106 Group
July 2023	<ul style="list-style-type: none"><li>• 60 percent design completed</li><li>• Archaeology literature review and assessment completed—no further action recommended</li><li>• Architectural history literature review and assessment completed—reconnaissance survey recommended</li></ul>
August 2023	<ul style="list-style-type: none"><li>• TEP and City of Savage approved wetland delineation boundaries</li><li>• 90 percent plans completed</li></ul>
October 2023	U.S. Army Corp of Engineers verifies that work is authorized by Transportation Regional General Permit
November 2023	<ul style="list-style-type: none"><li>• LMRWD granted conditional approval of the individual project permit</li><li>• Architectural history reconnaissance survey completed—no potential effects assessed</li></ul>
January 2024	100 percent of plans, bid package, and engineer’s opinion of probable cost completed

The next step in the project is to advertise the project for bids. The LMRWD will follow the procedures stipulated in Minnesota Statute 103D.811. The project will be advertised online through QuestCDN.com, an online interface for bidding. Additionally, a bid notice will be published in the Star Tribune. A copy of the advertisement is in Attachment 1. Proposals for the project will be received online through QuestCDN.com until a specified time and date. Subsequently, the bids will be opened and publicly read during a Microsoft Teams meeting. Bidders must submit all items as required by the Project Manual (Attachment 2) to be considered, including the Bid Form, Bid Security Form, and Responsible Contractor Verification and Certification of Compliance form. Young Environmental Consulting Group (Young Environmental) and BMI will review the lowest bidder for compliance with the prescribed requirements and evaluate the qualifications and experience of the primary bidder, subcontractors, and suppliers. After the bid opening, Young Environmental and BMI may request Bidder Qualifications to aid in their review. If any of the bids exceed the estimated construction cost by more than 30 percent, they will not be considered. The engineer's estimate for construction is \$814,641.30, which includes a 10 percent contingency (Attachment 3). Young Environmental will provide a memorandum recommending the lowest responsible bidder. The LMRWD's board of managers will have the opportunity to approve the contractor. After the contractor is approved, the LMRWD will send the Notice of Award.

The selected contractor will be required to provide the signed agreement, performance and payment bonds, insurance documentation, and subcontractors list within 15 days of the date of receipt of the Notice of Award. The LMRWD will then sign the Agreement and the Contract and share copies with the contractor. The construction of the Project will have a flexible start date but must be substantially completed on or before September 27, 2024, and completed and ready for final payment on or before October 11, 2024.

## **Recommendation**

We recommend conditional approval to advertise the Project for bids with modifications to the dates in the attachments once the funding strategy is approved.

## **Attachments**

- Attachment 1—Advertisement
- Attachment 2—Project Manual
- Attachment 3—Engineer's Cost Estimate



# PROJECT MANUAL

Vernon Avenue Improvements

OT1.129866

Lower Minnesota River Watershed District

Savage, MN



Real People. Real Solutions.

[Bolton-Menk.com](http://Bolton-Menk.com)

CERTIFICATIONS PAGE

PROJECT MANUAL

FOR

VERNON AVENUE IMPROVEMENTS

OT1.129866

LOWER MINNESOTA RIVER WATERSHED DISTRICT

SAVAGE, MN

I hereby certify that this plan, specification, or report was prepared by me or under my direct supervision, and that I am a duly Licensed Professional Engineer under the laws of the State of Minnesota.

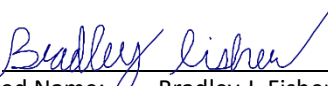
Signature:   
Typed or Printed Name: Bradley J. Fisher  
Date: 02/21/2024 License Number: 56595

## TABLE OF CONTENTS

Vernon Avenue Improvements  
OT1.129866  
Lower Minnesota River Watershed District

This Project Manual incorporates, either in full or in part, various EJCDC copyrighted documents. Documents incorporated in full are subject to the copyright notice in the EJCDC document footnotes. For those EJCDC documents excerpted, modified, or incorporated in part, those portions of the text that originated in copyrighted EJCDC documents remain subject to the EJCDC license and copyright. Copyright © 2018 National Society of Professional Engineers, American Council of Engineering Companies, and American Society of Civil Engineers. All rights reserved.

### CONTRACT DOCUMENTS:

#### PROJECT MANUAL:

Introductory Information, Bidding Requirements, Contract Forms and Conditions of Contract

00 01 05	CERTIFICATIONS PAGE
00 01 10	TABLE OF CONTENTS
00 11 13	ADVERTISEMENT FOR BIDS
00 21 13	INSTRUCTIONS TO BIDDERS
00 41 00	BID FORMS
00 43 13	BID SECURITY FORM
00 45 11	RESPONSIBLE CONTRACTOR VERIFICATION AND CERTIFICATION OF COMPLIANCE
00 45 16	BIDDERS QUALIFICATIONS
00 51 00	NOTICE OF AWARD
00 51 11	ADDITIONAL SUBCONTRACTORS LIST
00 52 00	AGREEMENT FORMS
00 55 00	NOTICE TO PROCEED
00 61 13.13	PERFORMANCE BOND FORM
00 61 13.16	PAYMENT BOND FORM
00 61 13.19	WARRANTY BOND FORM
00 72 00	C-700 2018 STANDARD GENERAL CONDITIONS OF THE CONSTRUCTION CONTRACT
00 73 00	C-800 2018 SUPPLEMENTARY CONDITIONS OF THE CONSTRUCTION CONTRACT

#### Specifications

00 63 36	FIELD ORDER FORM
00 63 49	WORK CHANGE DIRECTIVE FORM
00 63 63	CHANGE ORDER FORM
00 65 16	CERTIFICATE OF SUBSTANTIAL COMPLETION
01 11 00	SUMMARY OF WORK
01 23 00	ALTERNATES
01 29 00	PAYMENT PROCEDURES
01 31 00	PROJECT MANAGEMENT AND COORDINATION
01 31 19	PROJECT MEETINGS
01 33 00	SUBMITTAL PROCEDURES
01 35 13	SPECIAL PROJECT PROCEDURES
01 41 00	REGULATORY REQUIREMENTS
01 41 26	PERMIT REQUIREMENTS
01 42 13	ABBREVIATIONS AND ACRONYMS
01 42 19	REFERENCE STANDARDS

01 45 00 QUALITY CONTROL  
01 55 26 TRAFFIC CONTROL  
01 55 26.44 TRAFFIC CONTROL SPECIAL (RR FLAGGING)  
01 57 13 TEMPORARY EROSION & SEDIMENT CONTROL  
01 71 13 MOBILIZATION  
01 71 23 FIELD ENGINEERING  
01 77 00 CLOSEOUT PROCEDURES

**Technical Specifications**

02 41 13 SELECTIVE SITE DEMOLITION  
31 11 00 CLEARING AND GRUBBING  
31 20 00 EXCAVATIONS & EMBANKMENT  
31 23 13 SUBGRADE PREPARATION  
31 23 19 DEWATERING  
31 37 00 RIPRAP  
32 11 23 AGGREGATE BASE COURSES  
32 12 00 FLEXIBLE PAVING  
32 15 00 AGGREGATE SURFACING  
32 91 19.13 TOPSOIL PLACEMENT AND GRADING  
32 92 00 TURF AND GRASSES  
33 05 06 TRENCHING AND BACKFILLING  
33 42 00 STORMWATER CONVEYANCE  
33 42 13 STORMWATER CULVERTS  
34 41 05 TRAFFIC SIGNS AND DEVICES

**Appendices**

APPENDIX A - GEOTECHNICAL EVALUATION REPORT  
APPENDIX B - WORK IN UP RAILROAD ROW ASSOCIATED DOCUMENTS

**DRAWINGS (UNDER SEPARATE COVER):**

36 sheets numbered G0.01 through C8.13, inclusive, dated 02/21/2024, and with each sheet bearing the following general title:

Vernon Avenue Improvements  
Lower Minnesota River Watershed District

**\*\*\*\*\*END OF SECTION\*\*\*\*\***



**ADVERTISEMENT FOR BIDS**

VERNON AVENUE IMPROVEMENTS  
OT1.129866

LOWER MINNESOTA RIVER WATERSHED DISTRICT  
SAVAGE, MN

**RECEIPT AND OPENING OF PROPOSALS:** Proposals for the work described below will be received online through QuestCDN.com until 10:00 am on March 14<sup>th</sup>, 2024 at which time the bids will be opened and publicly read through Microsoft Teams. Please use the below link or call-in number/Conference ID to see and/or hear the bid opening results:

1. Microsoft Teams online link: <http://tinyurl.com/yvf7jxwa>
2. Call: 612-428-8778 and enter Conference ID: 272 734 755#

**DESCRIPTION OF WORK:** The work includes the construction of approximately:

6,400	CU YD	EXCAVATION - COMMON
3,300	CU YD	SELECT GRANULAR EMBANKMENT
2,200	CU YD	AGGREGATE BASE CLASS 5
2,200	TON	BITUMINOUS PAVING MIXTURE
100	LIN FT	48" RC PIPE CULVERT

together with numerous related items of work, all in accordance with Plans and Specifications. This project is subject to Responsible Contractor Certification.

**COMPLETION OF WORK:** All work under the Contract must be complete by 10/11/2024.

**PLAN HOLDERS LIST, ADDENDUMS AND BID TABULATION:** The plan holders list, addendums and bid tabulations will be available for download on-line at [www.questcdn.com](http://www.questcdn.com) or [www.bolton-menk.com](http://www.bolton-menk.com).

**TO OBTAIN BID DOCUMENTS:** Complete digital project bidding documents are available at [www.questcdn.com](http://www.questcdn.com) or [www.bolton-menk.com](http://www.bolton-menk.com). You may view the digital plan documents for free by entering Quest project # 8956703 on the website's Project Search page. Documents may be downloaded for \$50.00. Please contact QuestCDN.com at 952-233-1632 or [info@questcdn.com](mailto:info@questcdn.com) for assistance in free membership registration, viewing, downloading, and working with this digital project information.

**BID SUBMITTAL:** A bid shall be submitted online no later than the date and time prescribed. For this project, the Owner will only be accepting online electronic bids through QuestCDN. To access the electronic bid form, download the project document and click online bidding button at the top of the advertisement. Prospective bidders must be on the plan holders list through QuestCDN for bids to be accepted.

**BID SECURITY:** A Proposal Bond in the amount of not less than 5 percent of the total amount bid, drawn in favor of Lower Minnesota River Watershed District shall accompany each bid.

**OWNER'S RIGHTS RESERVED:** The Owner reserves the right to reject any or all bids and to waive any irregularities and informalities therein and to award the Contract to other than the lowest bidder if, in their discretion, the interest of the Owner would be best served thereby.

**DATED:** February 21, 2024 /s/ Linda Loomis  
Administrator

**Published:**

QuestCDN: February 22, 2024 to March 14, 2024  
Star Tribune: February 22, 2024

**\*\*\*\*END OF SECTION\*\*\*\***



# INSTRUCTIONS TO BIDDERS

	Page
<b>ARTICLE 1 – DEFINED TERMS</b>	2
ARTICLE 2 – Bidding Documents	2
ARTICLE 3 – Qualifications Of Bidders	3
ARTICLE 4 – Pre-Bid Conference	3
ARTICLE 5 – Site and Other Areas; Existing Site Conditions; Examination of Site; Owner’s Safety Program; Other Work at the Site	3
ARTICLE 6 – Bidder’s Representations and Certifications	4
ARTICLE 7 – Interpretations and Addenda	5
ARTICLE 8 – Bid Security	5
ARTICLE 9 – Contract Times	5
ARTICLE 10 – Substitute and Or-Equal Items	6
ARTICLE 11 – Subcontractors, Suppliers, and Others	6
ARTICLE 12 – Preparation of Bid	7
ARTICLE 13 – Basis of Bid	8
ARTICLE 14 – Submittal of Bid	8
ARTICLE 15 –Modification and Withdrawal of Bid	8
ARTICLE 16 – Opening of Bids	9
ARTICLE 17 – Bids to Remain Subject to Acceptance	9
ARTICLE 18 – Evaluation of Bids and Award of Contract	9
ARTICLE 19 – Bonds and Insurance	10
ARTICLE 20 – Signing of Agreement	10
ARTICLE 21 – Sales and Use Taxes	10
ARTICLE 22 – Contracts to Be Assigned	10

## ARTICLE 1—DEFINED TERMS

- 1.01 Terms used in these Instructions to Bidders have the meanings indicated in the General Conditions and Supplementary Conditions. Additional terms used in these Instructions to Bidders have the meanings indicated below:
- A. Issuing Office—The office from which the Bidding Documents are to be issued, and which registers plan holders.

## ARTICLE 2—BIDDING DOCUMENTS

- 2.01 Bidder shall obtain a complete set of Bidding Requirements and proposed Contract Documents (together, the Bidding Documents). See the Agreement for a list of the Contract Documents. It is Bidder's responsibility to determine that it is using a complete set of documents in the preparation of a Bid. Bidder assumes sole responsibility for errors or misinterpretations resulting from the use of incomplete documents, by Bidder itself or by its prospective Subcontractors and Suppliers.
- 2.02 Bidding Documents are made available for the sole purpose of obtaining Bids for completion of the Project and permission to download or distribution of the Bidding Documents does not confer a license or grant permission or authorization for any other use. Authorization to download documents, or other distribution, includes the right for plan holders to print documents solely for their use, and the use of their prospective Subcontractors and Suppliers, provided the plan holder pays all costs associated with printing or reproduction. Printed documents may not be re-sold under any circumstances.
- 2.03 Bidder may register as a plan holder and obtain complete sets of Bidding Documents, in the number and format stated in the Advertisement or invitation to bid. Bidders may rely that sets of Bidding Documents obtained in this manner are complete unless an omission is blatant. Registered plan holders will receive Addenda issued by Owner.
- 2.04 Owner is not responsible for omissions in Bidding Documents or other documents obtained from plan rooms or other sources, or for a Bidder's failure to obtain Addenda if they are not a registered plan holder.
- 2.05 *Electronic Documents*
- A. When the Bidding Requirements indicate that electronic (digital) copies of the Bidding Documents are available, such documents will be made available to the Bidders as Electronic Documents in the manner specified.
1. Bidding Documents will be provided in Adobe PDF (Portable Document Format) (.pdf) that is readable by Adobe Acrobat Reader. It is the intent of the Engineer and Owner that such Electronic Documents are to be exactly representative of the paper copies of the documents. However, because the Owner and Engineer cannot totally control the transmission and receipt of Electronic Documents nor the Contractor's means of reproduction of such documents, the Owner and Engineer cannot and do not guarantee that Electronic Documents and reproductions prepared from those versions are identical in every manner to the paper copies.
- B. Unless otherwise stated in the Bidding Documents, the Bidder may use and rely upon complete sets of Electronic Documents of the Bidding Documents, described in Paragraph 2.06.A above. However, Bidder assumes all risks associated with differences arising from transmission/receipt of Electronic Documents versions of Bidding Documents and reproductions prepared from those versions and, further, assumes all risks, costs, and responsibility associated with use of the Electronic Documents versions to derive information that is not explicitly contained in printed paper versions of the documents, and for Bidder's reliance upon such derived information.

### **ARTICLE 3—QUALIFICATIONS OF BIDDERS**

To demonstrate Bidder's qualifications to perform the Work, after submitting its Bid and within 5 days of Owner's request, Bidder must submit the following information:

- A. Written evidence establishing its qualifications such as financial data, previous experience, and present commitments.
- B. A written statement that Bidder is authorized to do business in the state where the Project is located, or a written certification that Bidder will obtain such authority prior to the Effective Date of the Contract.
- C. Bidder's state or other contractor license number, if applicable.
- D. Subcontractor and Supplier qualification information.
- E. Other required information regarding qualifications.

### **ARTICLE 4—PRE-BID CONFERENCE**

4.01 A pre-bid conference will not be conducted for this Project.

### **ARTICLE 5—SITE AND OTHER AREAS; EXISTING SITE CONDITIONS; EXAMINATION OF SITE; OWNER'S SAFETY PROGRAM; OTHER WORK AT THE SITE**

#### **5.01 *Site and Other Areas***

- A. The Site is identified in the Bidding Documents. By definition, the Site includes rights-of-way, easements, and other lands furnished by Owner for the use of the Contractor. Any additional lands required for temporary construction facilities, construction equipment, or storage of materials and equipment, and any access needed for such additional lands, are to be obtained and paid for by Contractor.

#### **5.02 *Existing Site Conditions***

- A. Subsurface and Physical Conditions; Hazardous Environmental Conditions
  - 1. The Supplementary Conditions identify the following regarding existing conditions at or adjacent to the Site:
    - a. Those reports of explorations and tests of subsurface conditions at or adjacent to the Site that contain Technical Data.
    - b. Those drawings known to Owner of existing physical conditions at or adjacent to the Site, including those drawings depicting existing surface or subsurface structures at or adjacent to the Site (except Underground Facilities), that contain Technical Data.
    - c. Reports and drawings known to Owner relating to Hazardous Environmental Conditions that have been identified at or adjacent to the Site.
      - 1) Technical Data contained in such reports and drawings.
  - 2. Owner will make copies of reports and drawings referenced above available to any Bidder on request. These reports and drawings are not part of the Contract Documents, but the Technical Data contained therein upon whose accuracy Bidder is entitled to rely, as provided in the General Conditions, has been identified and established in the Supplementary Conditions. Bidder is responsible for any interpretation or conclusion Bidder draws from any Technical Data or any other data, interpretations, opinions, or information contained in such reports or shown or indicated in such drawings.

---

This document is a MODIFIED version of EJCDC® C-200, Copyright© 2018 by NSPE, ACEC, and ASCE. All rights reserved.

3. If the Supplementary Conditions do not identify Technical Data, the default definition of Technical Data set forth in Article 1 of the General Conditions will apply.

B. *Underground Facilities:* Underground Facilities are shown or indicated on the Drawings, pursuant to Paragraph 5.05 of the General Conditions, and not in the drawings referred to in Paragraph 5.02.A of these Instructions to Bidders. Information and data regarding the presence or location of Underground Facilities are not intended to be categorized, identified, or defined as Technical Data.

5.03 *Other Site-related Documents*

A. In addition to the documents regarding existing Site conditions referred to in Paragraph 5.02.A, the following other documents relating to conditions at or adjacent to the Site are known to Owner and made available to Bidders for reference:

1. No other site related documents are available.

5.04 *Site Visit and Testing by Bidders*

A. Bidder is required to visit the Site and conduct a thorough visual examination of the Site and adjacent areas. During the visit, the Bidder must not disturb any ongoing operations at the Site.

B. Bidder shall conduct the required Site visit during normal working hours.

C. Bidder is not required to conduct any subsurface testing, or exhaustive investigations of Site conditions.

D. On request, and to the extent Owner has control over the Site, and schedule permitting, the Owner will provide Bidder general access to the Site to conduct such additional examinations, investigations, explorations, tests, and studies as Bidder deems necessary for preparing and submitting a successful Bid. Owner will not have any obligation to grant such access if doing so is not practical because of existing operations, security or safety concerns, or restraints on Owner's authority regarding the Site. Bidder is responsible for establishing access needed to reach specific selected test sites.

E. Bidder must comply with all applicable Laws and Regulations regarding excavation and location of utilities, obtain all permits, and comply with all terms and conditions established by Owner or by property owners or other entities controlling the Site with respect to schedule, access, existing operations, security, liability insurance, and applicable safety programs.

F. Bidder must fill all holes and clean up and restore the Site to its former condition upon completion of such explorations, investigations, tests, and studies.

5.05 *Owner's Safety Program*

A. Site visits and work at the Site may be governed by an Owner safety program. If an Owner safety program exists, it will be noted in the Supplementary Conditions.

5.06 *Other Work at the Site*

A. Reference is made to Article 8 of the Supplementary Conditions for the identification of the general nature of other work of which Owner is aware (if any) that is to be performed at the Site by Owner or others (such as utilities and other prime contractors) and relates to the Work contemplated by these Bidding Documents. If Owner is party to a written contract for such other work, then on request, Owner will provide to each Bidder access to examine such contracts (other than portions thereof related to price and other confidential matters), if any.

**ARTICLE 6—BIDDER'S REPRESENTATIONS AND CERTIFICATIONS**

6.01 Express Representations and Certifications in Bid Form, Agreement

This document is a MODIFIED version of EJCDC® C-200, Copyright© 2018 by NSPE, ACEC, and ASCE. All rights reserved.

- A. The Bid Form that each Bidder will submit contains express representations regarding the Bidder's examination of Project documentation, Site visit, and preparation of the Bid, and certifications regarding lack of collusion or fraud in connection with the Bid. Bidder should review these representations and certifications and assure that Bidder can make the representations and certifications in good faith, before executing and submitting its Bid.
- B. If Bidder is awarded the Contract, Bidder (as Contractor) will make similar express representations and certifications when it executes the Agreement.

#### **ARTICLE 7—INTERPRETATIONS AND ADDENDA**

- 7.01 Owner on its own initiative may issue Addenda to clarify, correct, supplement, or change the Bidding Documents.
- 7.02 Bidder shall submit all questions about the meaning or intent of the Bidding Documents to Engineer in writing to the Issuing Office. Contact information and submittal procedures for such questions are as follows:  
  
12224 Nicollet Avenue, Burnsville, MN 55337-1649, (952) 890-0509, fax (952) 890-8065
- 7.03 Interpretations or clarifications considered necessary by Engineer in response to such questions will be issued by Addenda delivered to all registered plan holders. Questions received less than seven days prior to the date for opening of Bids may not be answered.
- 7.04 Only responses set forth in an Addendum will be binding. Oral and other interpretations or clarifications will be without legal effect. Responses to questions are not part of the Contract Documents unless set forth in an Addendum that expressly modifies or supplements the Contract Documents.

#### **ARTICLE 8—BID SECURITY**

- 8.01 A Bid must be accompanied by Bid security made payable to Owner in an amount of 5 percent of Bidder's maximum Bid price (determined by adding the base bid and all alternates) and in the form of a Bid bond issued by a surety meeting the requirements of Paragraph 6.01 of the General Conditions. Such Bid bond will be issued in the form included in the Bidding Documents or the unmodified EJCDC version of the same form.
- 8.02 The Bid security of the apparent Successful Bidder will be retained until Owner awards the contract to such Bidder, and such Bidder has executed the Contract, furnished the required Contract security, and met the other conditions of the Notice of Award, whereupon the Bid security will be released. If the Successful Bidder fails to execute and deliver the Contract and furnish the required Contract security within 15 days after the Notice of Award, Owner may consider Bidder to be in default, annul the Notice of Award, and the Bid security of that Bidder will be forfeited, in whole in the case of a penal sum bid bond, and to the extent of Owner's damages in the case of a damages-form bond. Such forfeiture will be Owner's exclusive remedy if Bidder defaults.
- 8.03 The Bid security of other Bidders that Owner believes to have a reasonable chance of receiving the award may be retained by Owner until the earlier of 7 days after the Effective Date of the Contract or 61 days after the Bid opening, whereupon Bid security furnished by such Bidders will be released.
- 8.04 Bid security of other Bidders that Owner believes do not have a reasonable chance of receiving the award will be released within 7 days after the Bid opening.

#### **ARTICLE 9—CONTRACT TIMES**

---

This document is a MODIFIED version of EJCDC® C-200, Copyright© 2018 by NSPE, ACEC, and ASCE. All rights reserved.

- 9.01 The number of days within which, or the dates by which, the Work is to be (a) substantially completed and (b) ready for final payment, and (c) Milestones (if any) are to be achieved, are set forth in the Agreement.
- 9.02 Provisions for liquidated damages, if any, for failure to timely attain a Milestone, Substantial Completion, or completion of the Work in readiness for final payment, are set forth in the Agreement.

#### **ARTICLE 10—SUBSTITUTE AND “OR EQUAL” ITEMS**

- 10.01 The Contract for the Work, as awarded, will be on the basis of materials and equipment specified or described in the Bidding Documents without consideration during the bidding and Contract award process of possible substitute or “or-equal” items. In cases in which the Contract allows the Contractor to request that Engineer authorize the use of a substitute or “or-equal” item of material or equipment, application for such acceptance may not be made to and will not be considered by Engineer until after the Effective Date of the Contract.
- 10.02 The Contract for the Work, as awarded, will be on the basis of materials and equipment specified or described in the Bidding Documents, and those “or-equal” or substitute or materials and equipment subsequently approved by Engineer prior to the submittal of Bids and identified by Addendum. No item of material or equipment will be considered by Engineer as an “or-equal” or substitute unless written request for approval has been submitted by Bidder and has been received by Engineer within 10 days of the issuance of the Advertisement for Bids or invitation to Bidders. Each such request must comply with the requirements of Paragraphs 7.05 and 7.06 of the General Conditions, and the review of the request will be governed by the principles in those paragraphs. The burden of proof of the merit of the proposed item is upon Bidder. Engineer’s decision of approval or disapproval of a proposed item will be final. If Engineer approves any such proposed item, such approval will be set forth in an Addendum issued to all registered Bidders. Bidders cannot rely upon approvals made in any other manner.
- 10.03 All prices that Bidder sets forth in its Bid will be based on the presumption that the Contractor will furnish the materials and equipment specified or described in the Bidding Documents, as supplemented by Addenda. Any assumptions regarding the possibility of post-Bid approvals of “or-equal” or substitution requests are made at Bidder’s sole risk.

#### **ARTICLE 11—SUBCONTRACTORS, SUPPLIERS, AND OTHERS**

- 11.01 A Bidder must be prepared to retain specific Subcontractors and Suppliers for the performance of the Work if required to do so by the Bidding Documents or in the Specifications. If a prospective Bidder objects to retaining any such Subcontractor or Supplier and the concern is not relieved by an Addendum, then the prospective Bidder should refrain from submitting a Bid.
- 11.02 The apparent Successful Bidder, and any other Bidder so requested, must submit to Owner a list of the Subcontractors or Suppliers proposed for the following portions of the Work within five days after Bid opening:
- A. There are no key categories of work.
- 11.03 If requested by Owner, such list must be accompanied by an experience statement with pertinent information regarding similar projects and other evidence of qualification for each such Subcontractor or Supplier. If Owner or Engineer, after due investigation, has reasonable objection to any proposed Subcontractor or Supplier, Owner may, before the Notice of Award is given, request apparent Successful Bidder to submit an acceptable substitute, in which case apparent Successful Bidder will submit a substitute, Bidder’s Bid price will be increased (or decreased) by the difference in cost occasioned by such substitution, and Owner may consider such price adjustment in evaluating Bids and making the Contract award.

---

This document is a MODIFIED version of EJCDC® C-200, Copyright© 2018 by NSPE, ACEC, and ASCE. All rights reserved.



- 11.04 If apparent Successful Bidder declines to make any such substitution, Owner may award the Contract to the next lowest Bidder that proposes to use acceptable Subcontractors and Suppliers. Declining to make requested substitutions will constitute grounds for forfeiture of the Bid security of any Bidder. Any Subcontractor or Supplier, so listed and against which Owner or Engineer makes no written objection prior to the giving of the Notice of Award will be deemed acceptable to Owner and Engineer subject to subsequent revocation of such acceptance as provided in Paragraph 7.07 of the General Conditions.

## **ARTICLE 12—PREPARATION OF BID**

- 12.01 The Bid Form is included with the Bidding Documents.
- A. All blanks on the Bid Form must be completed.
  - B. Paper bids, if applicable, must be completed in ink and the Bid Form signed in ink. Erasures or alterations must be initialed in ink by the person signing the Bid Form.
  - C. A Bid price must be indicated for each section, bid item, alternate, adjustment unit price item, and unit price item listed therein.
  - D. If the Bid Form expressly indicates that submitting pricing on a specific alternate item is optional, and Bidder elects to not furnish pricing for such optional alternate item, then Bidder may enter the words “No Bid” or “Not Applicable.”
- 12.02 When submitting a paper bid, if Bidder has obtained the Bidding Documents as Electronic Documents, then Bidder shall prepare its Bid on a paper copy of the Bid Form printed from the Electronic Documents version of the Bidding Documents. The printed copy of the Bid Form must be clearly legible, printed on 8½ inch by 11-inch paper and as closely identical in appearance to the Electronic Document version of the Bid Form as may be practical. The Owner reserves the right to accept Bid Forms which nominally vary in appearance from the original paper version of the Bid Form, providing that all required information and submittals are included with the Bid.
- 12.03 A Bid by a corporation must be executed in the corporate name by a corporate officer (whose title must appear under the signature), accompanied by evidence of authority to sign. The corporate address and state of incorporation must be shown.
- 12.04 A Bid by a partnership must be executed in the partnership name and signed by a partner (whose title must appear under the signature), accompanied by evidence of authority to sign. The official address of the partnership must be shown.
- 12.05 A Bid by a limited liability company must be executed in the name of the firm by a member or other authorized person and accompanied by evidence of authority to sign. The state of formation of the firm and the official address of the firm must be shown.
- 12.06 A Bid by an individual must show the Bidder’s name and official address.
- 12.07 A Bid by a joint venture must be executed by an authorized representative of each joint venturer in the manner indicated on the Bid Form. The joint venture must have been formally established prior to submittal of a Bid, and the official address of the joint venture must be shown.
- 12.08 When submitting a paper bid, all names must be printed in ink below the signatures.
- 12.09 The Bid must contain an acknowledgment of receipt of all Addenda, the numbers of which must be filled in on the Bid Form.
- 12.10 Postal and e mail addresses and telephone number for communications regarding the Bid must be shown.

- 12.11 The Bid must contain evidence of Bidder’s authority to do business in the state where the Project is located, or Bidder must certify in writing that it will obtain such authority within the time for acceptance of Bids and attach such certification to the Bid.
- 12.12 If Bidder is required to be licensed to submit a Bid or perform the Work in the state where the Project is located, the Bid must contain evidence of Bidder’s licensure, or Bidder must certify in writing that it will obtain such licensure within the time for acceptance of Bids and attach such certification to the Bid. Bidder’s state contractor license number, if any, must also be shown on the Bid Form.

### **ARTICLE 13—BASIS OF BID**

#### Unit Price

- 13.01 Bidders must submit a Bid on a unit price basis for each item of Work listed in the unit price section of the Bid Form.
- A. The “Bid Price” (sometimes referred to as the extended price) for each unit price Bid item will be the product of the “Estimated Quantity”, which Owner or its representative has set forth in the Bid Form, for the item and the corresponding “Bid Unit Price” offered by the Bidder. The total of all unit price Bid items will be the sum of these “Bid Prices”; such total will be used by Owner for Bid comparison purposes. The final quantities and Contract Price will be determined in accordance with Paragraph 13.03 of the General Conditions.
- B. Discrepancies between the multiplication of units of Work and unit prices will be resolved in favor of the unit prices. Discrepancies between the indicated sum of any column of figures and the correct sum thereof will be resolved in favor of the correct sum.

### **ARTICLE 14—SUBMITTAL OF BID**

- 14.01 The Bid Form is to be completed and submitted with the Bid security and the other documents required to be submitted under the terms of Article 2 of the Bid Form.
- 14.02 A Bid must be received no later than the date and time prescribed and at the place indicated in the Advertisement or invitation to bid. Paper bids, if applicable, must be enclosed in a plainly marked package with the Project title, and, if applicable, the designated portion of the Project for which the Bid is submitted, the name and address of Bidder, and must be accompanied by the Bid security and other required documents. If a Bid is sent by mail or other delivery system, the sealed envelope containing the Bid must be enclosed in a separate package plainly marked on the outside with the notation “BID ENCLOSED.” A mailed Bid must be addressed to the location designated in the Advertisement.
- 14.03 Bids received after the date and time prescribed for the opening of bids, or not submitted at the correct location or in the designated manner, will not be accepted. Paper bids that are not accepted will be returned to the Bidder unopened.

### **ARTICLE 15—MODIFICATION AND WITHDRAWAL OF BID**

- 15.01 An unopened Bid may be withdrawn by an appropriate document duly executed in the same manner that a Bid must be executed and delivered to the place where Bids are to be submitted prior to the date and time for the opening of Bids. Upon receipt of such notice, the unopened Bid will be returned to the Bidder.
- 15.02 If a Bidder wishes to modify its Bid prior to Bid opening, Bidder must withdraw its initial Bid in the manner specified in Paragraph 15.01 and submit a new Bid prior to the date and time for the opening of Bids.
- 15.03 If within 24 hours after Bids are opened any Bidder files a duly signed written notice with Owner and promptly thereafter demonstrates to the reasonable satisfaction of Owner that there was a material and substantial mistake in the preparation of its Bid, the Bidder may withdraw its Bid, and the Bid security will

be returned. Thereafter, if the Work is rebid, the Bidder will be disqualified from further bidding on the Work.

#### **ARTICLE 16—OPENING OF BIDS**

16.01 Bids will be opened at the time and place indicated in the advertisement or invitation to bid and, unless obviously non-responsive, read aloud publicly. A tabulation of the total amounts of the base Bids and major alternates, if any, will be made available to Bidders after the opening of Bids.

#### **ARTICLE 17—BIDS TO REMAIN SUBJECT TO ACCEPTANCE**

17.01 All Bids will remain subject to acceptance for the period of time stated in the Bid Form, but Owner may, in its sole discretion, release any Bid and return the Bid security prior to the end of this period.

#### **ARTICLE 18—EVALUATION OF BIDS AND AWARD OF CONTRACT**

18.01 Owner reserves the right to reject any or all Bids, including without limitation, nonconforming, nonresponsive, unbalanced, or conditional Bids. Owner also reserves the right to waive all minor Bid informalities not involving price, time, or changes in the Work.

18.02 Owner will reject the Bid of any Bidder that Owner finds, after reasonable inquiry and evaluation, to not be responsible.

18.03 If Bidder purports to add terms or conditions to its Bid, takes exception to any provision of the Bidding Documents, or attempts to alter the contents of the Contract Documents for purposes of the Bid, whether in the Bid itself or in a separate communication to Owner or Engineer, then Owner will reject the Bid as nonresponsive.

18.04 If Owner awards the contract for the Work, such award will be to the responsible Bidder submitting the lowest responsive Bid.

##### *18.05 Evaluation of Bids*

A. In evaluating Bids, Owner will consider whether the Bids comply with the prescribed requirements, and such alternates, unit prices, and other data, as may be requested in the Bid Form or prior to the Notice of Award.

B. For the determination of the apparent low Bidder(s) when alternate(s) are submitted, Bids will be compared on the basis of the sum of the base bid and the alternate(s) selected by the Owner for award.

C. For determination of the apparent low Bidder(s) when sectional bids are submitted, Bids will be compared on the basis of the aggregate of the Bids for separate sections and the Bids for combined sections that result in the lowest total amount for all of the Work.

D. For the determination of the apparent low Bidder when unit price bids are submitted, Bids will be compared on the basis of the total of the products of the estimated quantity of each item and unit price Bid for that item, together with any lump sum items.

E. For the determination of the apparent low Bidder when cost-plus-fee bids are submitted, Bids will be compared on the basis of the Guaranteed Maximum Price set forth by Bidder on the Bid Form.

18.06 In evaluating whether a Bidder is responsible, Owner will consider the qualifications of the Bidder and may consider the qualifications and experience of Subcontractors and Suppliers proposed for those portions of the Work for which the identity of Subcontractors and Suppliers must be submitted as provided in the Bidding Documents.

18.07 Owner may conduct such investigations as Owner deems necessary to establish the responsibility, qualifications, and financial ability of Bidders and any proposed Subcontractors or Suppliers.

**ARTICLE 19—BONDS AND INSURANCE**

19.01 Article 6 of the General Conditions, as may be modified by the Supplementary Conditions, sets forth Owner’s requirements as to performance and payment bonds, other required bonds (if any), and insurance. When the Successful Bidder delivers the executed Agreement to Owner, it must be accompanied by required bonds and insurance documentation.

19.02 Article 8, Bid Security, of these Instructions, addresses any requirements for providing bid bonds as part of the bidding process.

**ARTICLE 20—SIGNING OF AGREEMENT**

20.01 When Owner issues a Notice of Award to the Successful Bidder, it will be accompanied by the unexecuted counterparts of the Agreement along with the other Contract Documents as identified in the Agreement. Within 15 days thereafter, Successful Bidder must execute and deliver the required number of counterparts of the Agreement and any bonds and insurance documentation required to be delivered by the Contract Documents to Owner. Within 10 days thereafter, Owner will deliver one fully executed counterpart of the Agreement to Successful Bidder, together with printed and electronic copies of the Contract Documents as stated in Paragraph 2.02 of the General Conditions.

**ARTICLE 21—SALES AND USE TAXES**

21.01 Sales tax is to be included in the Bid.

**ARTICLE 22—CONTRACTS TO BE ASSIGNED**

**ARTICLE 23—22.01** No Supplementary Conditions in this Article.

**Items to Be Submitted with the Bid**

**for**

**Vernon Avenue Improvements**

**0T1.129866**

**Lower Minnesota River Watershed District**

**Savage, MN**

# BID FORMS

Vernon Avenue Improvements  
OT1.129866

The terms used in this Bid with initial capital letters have the meanings stated in the Instructions to Bidders, the General Conditions, and the Conditions.

## ARTICLE 1—OWNER AND BIDDER

- 1.01 This Bid is submitted to: Lower Minnesota River Watershed District, 112 E. 5th St, Suite #102, Chaska, MN 55318. Refer to the Advertisement for Bids for submittal location, format, and deadline for consideration.
- 1.02 This bid form is provided for Bidders reference. The Bid must be submitted to Lower Minnesota River Watershed District electronically through QuestCDN.
- 1.03 The undersigned Bidder proposes and agrees, if this Bid is accepted, to enter into an Agreement with Owner in the form included in the Bidding Documents to perform all Work as specified or indicated in the Bidding Documents for the prices and within the times indicated in this Bid and in accordance with the other terms and conditions of the Bidding Documents.

## ARTICLE 2—ATTACHMENTS TO THIS BID

- 2.01 The following documents are submitted with and made a condition of this Bid:
  - A. Required Bid security;
  - B. Section 00 45 11 Responsible Contractor Verification and Certification of Compliance Prime Contractor Bid Form Attachment of this Project Manual.

## ARTICLE 3—BASIS OF BID

- 3.01 Unit Price Bids
- 3.02 Bidder will perform the Work listed in the Bid Schedule at the indicated unit prices.
  - A. Bidder acknowledges that:
    1. Each Bid Unit Price includes an amount considered by Bidder to be adequate to cover Contractor's overhead and profit for each separately identified item, and
    2. Estimated quantities are not guaranteed, and are solely for the purpose of comparison of Bids, and final payment for all Unit Price Work will be based on actual quantities, determined as provided in the Contract Documents.

## ARTICLE 4—TIME OF COMPLETION

- 4.01 Bidder agrees that the Work will be substantially complete and will be completed and ready for final payment in accordance with Paragraph 15.06 of the General Conditions on or before the dates or within the number of calendar days indicated in the Agreement.

## ARTICLE 5—BIDDER'S ACKNOWLEDGEMENTS: ACCEPTANCE PERIOD, INSTRUCTIONS, AND RECEIPT OF ADDENDA

- 5.01 Bid Acceptance Period
  - A. This Bid will remain subject to acceptance for 61 days after the Bid opening, or for such longer period of time that Bidder may agree to in writing upon request of Owner.

---

This document is a MODIFIED version of EJCDC® C-410, Copyright© 2018 by NSPE, ACEC, and ASCE. All rights reserved.

5.02 Instructions to Bidders

- A. Bidder accepts all of the terms and conditions of the Instructions to Bidders, including without limitation those dealing with the disposition of Bid security.

5.03 Receipt of Addenda

- A. Bidder hereby acknowledges receipt of the following Addenda:

Addendum Number	Addendum Date

**ARTICLE 6—BIDDER’S REPRESENTATIONS AND CERTIFICATIONS**

6.01 Bidder’s Representations

- A. In submitting this Bid, Bidder represents the following:
  - 1. Bidder has examined and carefully studied the Bidding Documents, including Addenda.
  - 2. Bidder has visited the Site, conducted a thorough visual examination of the Site and adjacent areas, and become familiar with the general, local, and Site conditions that may affect cost, progress, and performance of the Work.
  - 3. Bidder is familiar with all Laws and Regulations that may affect cost, progress, and performance of the Work.
  - 4. Bidder has carefully studied the reports of explorations and tests of subsurface conditions at or adjacent to the Site and the drawings of physical conditions relating to existing surface or subsurface structures at the Site that have been identified in the Supplementary Conditions, with respect to the Technical Data in such reports and drawings.
  - 5. Bidder has carefully studied the reports and drawings relating to Hazardous Environmental Conditions, if any, at or adjacent to the Site that have been identified in the Supplementary Conditions, with respect to Technical Data in such reports and drawings.
  - 6. Bidder has considered the information known to Bidder itself; information commonly known to contractors doing business in the locality of the Site; information and observations obtained from visits to the Site; the Bidding Documents; and the Technical Data identified in the Supplementary Conditions or by definition, with respect to the effect of such information, observations, and Technical Data on (a) the cost, progress, and performance of the Work; (b) the means, methods, techniques, sequences, and procedures of construction to be employed by Bidder, if selected as Contractor; and (c) Bidder’s (Contractor’s) safety precautions and programs.
  - 7. Based on the information and observations referred to in the preceding paragraph, Bidder agrees that no further examinations, investigations, explorations, tests, studies,

or data are necessary for the performance of the Work at the Contract Price, within the Contract Times, and in accordance with the other terms and conditions of the Contract.

8. Bidder is aware of the general nature of work to be performed by Owner and others at the Site that relates to the Work as indicated in the Bidding Documents.
9. Bidder has given Engineer written notice of all conflicts, errors, ambiguities, or discrepancies that Bidder has discovered in the Bidding Documents, and of discrepancies between Site conditions and the Contract Documents, and the written resolution thereof by Engineer is acceptable to Contractor.
10. The Bidding Documents are generally sufficient to indicate and convey understanding of all terms and conditions for performance and furnishing of the Work.
11. The submission of this Bid constitutes an incontrovertible representation by Bidder that without exception the Bid and all prices in the Bid are premised upon performing and furnishing the Work required by the Bidding Documents.

#### 6.02 Bidder's Certifications

##### A. The Bidder certifies the following:

1. This Bid is genuine and not made in the interest of or on behalf of any undisclosed individual or entity and is not submitted in conformity with any collusive agreement or rules of any group, association, organization, or corporation.
2. Bidder has not directly or indirectly induced or solicited any other Bidder to submit a false or sham Bid.
3. Bidder has not solicited or induced any individual or entity to refrain from bidding.
4. Bidder has not engaged in corrupt, fraudulent, collusive, or coercive practices in competing for the Contract. For the purposes of this Paragraph 8.02.A:
  - a. Corrupt practice means the offering, giving, receiving, or soliciting of anything of value likely to influence the action of a public official in the bidding process.
  - b. Fraudulent practice means an intentional misrepresentation of facts made (a) to influence the bidding process to the detriment of Owner, (b) to establish bid prices at artificial non-competitive levels, or (c) to deprive Owner of the benefits of free and open competition.
  - c. Collusive practice means a scheme or arrangement between two or more Bidders, with or without the knowledge of Owner, a purpose of which is to establish bid prices at artificial, non-competitive levels.
  - d. Coercive practice means harming or threatening to harm, directly or indirectly, persons or their property to influence their participation in the bidding process or affect the execution of the Contract.



BIDDER hereby submits this Bid as set forth above:

Bidder:

\_\_\_\_\_  
*(typed or printed name of organization)*

By: \_\_\_\_\_  
*(individual's signature)*

Name: \_\_\_\_\_  
*(typed or printed)*

Title: \_\_\_\_\_  
*(typed or printed)*

Date: \_\_\_\_\_  
*(typed or printed)*

*If Bidder is a corporation, a partnership, or a joint venture, attach evidence of authority to sign.*

Attest: \_\_\_\_\_  
*(individual's signature)*

Name: \_\_\_\_\_  
*(typed or printed)*

Title: \_\_\_\_\_  
*(typed or printed)*

Date: \_\_\_\_\_  
*(typed or printed)*

Address for giving notices:

\_\_\_\_\_  
\_\_\_\_\_

Bidder's Contact:

Name: \_\_\_\_\_  
*(typed or printed)*

Title: \_\_\_\_\_  
*(typed or printed)*

Phone: \_\_\_\_\_

Email: \_\_\_\_\_

Address: \_\_\_\_\_  
\_\_\_\_\_  
\_\_\_\_\_

Bidder's Contractor License No.: (if applicable) \_\_\_\_\_

# SCHEDULE OF BID PRICES

LOWER MINNESOTA RIVER WATERSHED DISTRICT  
 VERNON AVENUE IMPROVEMENTS  
 CITY OF SAVAGE, MINNESOTA  
 BMI PROJECT NO. 0T1.129866

BIDDER agrees to perform all of the work described in the CONTRACT DOCUMENTS for the following unit prices:

NOTE: BIDS shall include sales tax and all applicable taxes and fees.

BIDDER must fill in unit prices in numerals, make extension for each item, and total.

- (1) INCLUDES REMOVAL OF PIPE APRONS AND ASSOCIATED APPURTENANCES.
- (2) PAVEMENT DEPTHS ARE APPROXIMATE AND ARE REFERENCED IN THE GEOTECHNICAL REPORT. VARIANCE IN PAVEMENT THICKNESS WILL NOT BE COMPENSATED AND IS TO BE USED AS DIRECTED BY THE ENGINEER.
- (3) TO BE USED AS DIRECTED BY THE ENGINEER.
- (4) INCLUDES ALL WORK NECESSARY TO PROVIDE A STREAM/DITCH BYPASS AND DEWATERING, AS NECESSARY, TO ALLOW FOR CONSTRUCTION OF THE STORM CULVERT
- (5) INCLUDES THE CLEARING OF ACCUMULATED DEBRIS AND RE-GRADING DITCHES TO PROVIDE PROPER DRAINAGE AS THEY APPROACH THE NEW CULVERT APRONS.
- (6) INCLUDES FURNISHING & INSTALLATION OF TRASH GUARD, AS INDICATED IN THE DETAILS.
- (7) INCLUDES FURNISHING & INSTALLATION OF PIPE TIES ON ALL PIPE JOINTS ALONG THE CULVERT AND INSTALLATION OF FINE AGGREGATE BEDDING, AS INDICATED IN THE DETAILS.
- (8) INCLUDES THE FURNISHING AND INSTALLATION OF GEOTEXTILE FABRIC, AS SPECIFIED.
- (9) NEW SIGN PANELS AND SALVAGED SIGNS TO BE REINSTALLED SHALL INCLUDE NEW SIGN POSTS, HARDWARE, AND INSTALLATION AS REQUIRED AND SHALL BE INCLUDED IN THE BID.
- (10) INCLUDES THE FURNISHING AND INSTALLATION OF FERTILIZER AND SEED MIXTURE, AS SPECIFIED.
- (CV) COMPACTED VOLUME
- (EV) EXCAVATED VOLUME
- (LV) LOOSE VOLUME
- (P) PLAN QUANTITY

ITEM NO.	MNDOT SPEC NO.	ITEM	NOTES	UNIT	EST. QTY	UNIT PRICE	AMOUNT
1	2021.501	MOBILIZATION		LUMP SUM	1.00		
2	2101.502	CLEARING		EACH	48.0		
3	2101.502	GRUBBING		EACH	48.0		
4	2104.502	SALVAGE SIGN		EACH	1.0		
5	2104.503	SAWING BITUMINOUS PAVEMENT (FULL DEPTH)		LIN FT	26.0		
6	2104.503	REMOVE SEWER PIPE (STORM)	(1)	LIN FT	96.0		
7	2104.504	REMOVE BITUMINOUS PAVEMENT	(P)(2)	SQ YD	9,320.0		
8	2104.507	REMOVE RIPRAP	(EV)	CU YD	40.0		
9	2106.507	EXCAVATION - COMMON	(EV)(P)	CU YD	6,358.0		
10	2106.507	EXCAVATION - SUBGRADE	(EV)(3)	CU YD	262.0		
11	2106.507	SELECT GRANULAR EMBANKMENT	(CV)(P)	CU YD	3,366.0		
12	2106.507	STABILIZING AGGREGATE	(CV)(3)	CU YD	262.0		
13	2106.601	DEWATERING	(4)	LUMP SUM	1.0		
14	2106.603	MINOR GRADING	(5)	LIN FT	80.0		
15	2118.507	AGGREGATE SURFACING CLASS 2	(CV)(P)	CU YD	188.0		
16	2123.510	COMMON LABORERS	(3)	HOUR	15.0		
17	2123.510	DOZER	(3)	HOUR	5.0		
18	2123.610	CRAWLER MOUNTED BACKHOE	(3)	HOUR	5.0		
19	2211.507	AGGREGATE BASE CLASS 5	(CV)(P)	CU YD	2,244.0		
20	2357.506	BITUMINOUS MATERIAL FOR TACK COAT		GAL	550.0		
21	2360.509	TYPE SP 9.5 WEARING COURSE MIXTURE (3,C)		TON	1,848.0		
22	2501.502	48" RC PIPE APRON	(6)(7)	EACH	2.0		
23	2503.503	48" RC PIPE SEWER CLASS III	(7)	LIN FT	84.0		
24	2511.507	RANDOM RIPRAP CLASS III	(8)	CU YD	80.0		
25	2563.601	TRAFFIC CONTROL		LUMP SUM	1.0		
26	2564.602	INSTALL SIGN	(9)	EACH	1.0		
27	2572.602	TREE PRUNING	(3)	HOUR	12.0		
28	2573.501	STABILIZED CONSTRUCTION EXIT		LUMP SUM	1.0		
29	2573.502	STORM DRAIN INLET PROTECTION		EACH	3.0		
30	2573.503	FLOTATION SILT CURTAIN TYPE STILL WATER		LIN FT	40.0		
31	2573.503	SEDIMENT CONTROL LOG TYPE WOOD FIBER		LIN FT	14,000.0		
32	2574.507	COMMON TOPSOIL BORROW	(LV)	CU YD	1,426.0		
33	2575.504	ROLLED EROSION PREVENTION CATEGORY 20 W/ SEED MIX (25-141)	(10)	SQ YD	8,295.0		
34	2575.504	ROLLED EROSION PREVENTION CATEGORY 20 W/ SEED MIX (34-181)	(10)	SQ YD	257.0		
35	2563.621	TRAFFIC CONTROL SPECIAL (RR FLAGGING)		DOL	15,000.0	\$1.00	\$15,000.00

**TOTAL PROJECT BID =**

## BID SECURITY FORM

<b>Bidder</b> Name: Address <i>(principal place of business)</i> :	<b>Surety</b> Name: Address <i>(principal place of business)</i> :
<b>Owner</b> Name: Lower Minnesota River Watershed District Address <i>(principal place of business)</i> : 112 E. 5th St, Suite #102 Chaska, MN 55318	<b>Bid</b> Project <i>(name and location)</i> : Vernon Avenue Improvements  Bid Due Date: 03/14/2024
<b>Bond</b> Penal Sum: Date of Bond:	
Surety and Bidder, intending to be legally bound hereby, subject to the terms set forth in this Bid Bond, do each cause this Bid Bond to be duly executed by an authorized officer, agent, or representative.	
Bidder _____ <i>(Full formal name of Bidder)</i>	Surety _____ <i>(Full formal name of Surety) (corporate seal)</i>
By: _____ <i>(Signature)</i>	By: _____ <i>(Signature) (Attach Power of Attorney)</i>
Name: _____ <i>(Printed or typed)</i>	Name: _____ <i>(Printed or typed)</i>
Title: _____	Title: _____
Attest: _____ <i>(Signature)</i>	Attest: _____ <i>(Signature)</i>
Name: _____ <i>(Printed or typed)</i>	Name: _____ <i>(Printed or typed)</i>
Title: _____	Title: _____
<i>Notes: (1) Note: Addresses are to be used for giving any required notice. (2) Provide execution by any additional parties, such as joint venturers, if necessary.</i>	

1. Bidder and Surety, jointly and severally, bind themselves, their heirs, executors, administrators, successors, and assigns to pay to Owner upon default of Bidder the penal sum set forth on the face of this Bond. Payment of the penal sum is the extent of Bidder's and Surety's liability. Recovery of such penal sum under the terms of this Bond will be Owner's sole and exclusive remedy upon default of Bidder.
2. Default of Bidder occurs upon the failure of Bidder to deliver within the time required by the Bidding Documents (or any extension thereof agreed to in writing by Owner) the executed Agreement required by the Bidding Documents and any performance and payment bonds required by the Bidding Documents.
3. This obligation will be null and void if:
  - 3.1. Owner accepts Bidder's Bid and Bidder delivers within the time required by the Bidding Documents (or any extension thereof agreed to in writing by Owner) the executed Agreement required by the Bidding Documents and any performance and payment bonds required by the Bidding Documents, or
  - 3.2. All Bids are rejected by Owner, or
  - 3.3. Owner fails to issue a Notice of Award to Bidder within the time specified in the Bidding Documents (or any extension thereof agreed to in writing by Bidder and, if applicable, consented to by Surety when required by Paragraph 5 hereof).
4. Payment under this Bond will be due and payable upon default of Bidder and within 30 calendar days after receipt by Bidder and Surety of written notice of default from Owner, which notice will be given with reasonable promptness, identifying this Bond and the Project and including a statement of the amount due.
5. Surety waives notice of any and all defenses based on or arising out of any time extension to issue Notice of Award agreed to in writing by Owner and Bidder, provided that the total time for issuing Notice of Award including extensions does not in the aggregate exceed 120 days from the Bid due date without Surety's written consent.
6. No suit or action will be commenced under this Bond prior to 30 calendar days after the notice of default required in Paragraph 4 above is received by Bidder and Surety, and in no case later than one year after the Bid due date.
7. Any suit or action under this Bond will be commenced only in a court of competent jurisdiction located in the state in which the Project is located.
8. Notices required hereunder must be in writing and sent to Bidder and Surety at their respective addresses shown on the face of this Bond. Such notices may be sent by personal delivery, commercial courier, or by United States Postal Service registered or certified mail, return receipt requested, postage pre-paid, and will be deemed to be effective upon receipt by the party concerned.
9. Surety shall cause to be attached to this Bond a current and effective Power of Attorney evidencing the authority of the officer, agent, or representative who executed this Bond on behalf of Surety to execute, seal, and deliver such Bond and bind the Surety thereby.
10. This Bond is intended to conform to all applicable statutory requirements. Any applicable requirement of any applicable statute that has been omitted from this Bond will be deemed to be included herein as if set forth at length. If any provision of this Bond conflicts with any applicable statute, then the provision of said statute governs and the remainder of this Bond that is not in conflict therewith continues in full force and effect.
11. The term "Bid" as used herein includes a Bid, offer, or proposal as applicable.

# RESPONSIBLE CONTRACTOR VERIFICATION AND CERTIFICATION OF COMPLIANCE

## PRIME CONTRACTOR BID FORM ATTACHMENT

PROJECT NUMBER: OT1.129866

**This form includes changes by statutory references from the Laws of Minnesota 2015, chapter 64, sections 1-9. This form must be submitted with the bid form submitted for this project. A bid form received without this form, may be rejected.**

	<p>Minn. Stat. § 16C.285, Subd. 7. <b>IMPLEMENTATION.</b> ... any prime contractor or subcontractor or motor carrier that does not meet the minimum criteria in subdivision 3 or fails to verify that it meets those criteria is not a responsible contractor and is not eligible to be awarded a construction contract for the project or to perform work on the project...</p>
	<p>Minn. Stat. § 16C.285, Subd. 3. <b>RESPONSIBLE CONTRACTOR, MINIMUM CRITERIA.</b> "Responsible contractor" means a contractor that conforms to the responsibility requirements in the solicitation document for its portion of the work on the project and verifies that it meets the following minimum criteria:</p>
(1)	<p>The Contractor:</p> <ul style="list-style-type: none"> <li>(i) is in compliance with workers' compensation and unemployment insurance requirements;</li> <li>(ii) is in compliance with Department of Revenue and Department of Employment and Economic Development registration requirements if it has employees;</li> <li>(iii) has a valid federal tax identification number or a valid Social Security number if an individual; and</li> <li>(iv) has filed a certificate of authority to transact business in Minnesota with the Secretary of State if a foreign corporation or cooperative.</li> </ul>
(2)	<p>The contractor or related entity is in compliance with and, during the three-year period before submitting the verification, has not violated section 177.24, 177.25, 177.41 to 177.44, 181.03, 181.101, 181.13, 181.14, or 181.722, and has not violated United States Code, title 29, sections 201 to 219, or United States Code, title 40, sections 3141 to 3148. For purposes of this clause, a violation occurs when a contractor or related entity:</p> <ul style="list-style-type: none"> <li>(i) repeatedly fails to pay statutorily required wages or penalties on one or more separate projects for a total underpayment of \$25,000 or more within the three-year period, provided that a failure to pay is "repeated" only if it involves two or more separate and distinct occurrences of underpayment during the three-year period;</li> <li>(ii) has been issued an order to comply by the commissioner of Labor and Industry that has become final;</li> <li>(iii) has been issued at least two determination letters within the three-year period by the Department of Transportation finding an underpayment by the contractor or related entity to its own employees;</li> <li>(iv) has been found by the commissioner of Labor and Industry to have repeatedly or willfully violated any of the sections referenced in this clause pursuant to section 177.27;</li> <li>(v) has been issued a ruling or findings of underpayment by the administrator of the Wage and Hour Division of the United States Department of Labor that have become final or have been upheld by an administrative law judge or the Administrative Review Board; or</li> <li>(vi) has been found liable for underpayment of wages or penalties or misrepresenting a construction worker as an independent contractor in an action brought in a court having jurisdiction. Provided that, if the contractor or related entity contests a determination of underpayment by the Department of Transportation in a contested case proceeding, a violation does not occur until the contested case proceeding has concluded with a determination that the contractor or related entity underpaid wages or penalties;*</li> </ul>

This document is a MODIFIED version of the MnDOT Responsible Contractor Verification and Certification of Compliance form

Lower Minnesota River Watershed District - OT1.129866

RESPONSIBLE CONTRACTOR VERIFICATION AND  
CERTIFICATION OF COMPLIANCE

February 21, 2024

PAGE 00 45 11-1

(3)	The contractor or related entity is in compliance with and, during the three-year period before submitting the verification, has not violated section 181.723 or chapter 326B. For purposes of this clause, a violation occurs when a contractor or related entity has been issued a final administrative or licensing order;*
(4)	The contractor or related entity has not, more than twice during the three-year period before submitting the verification, had a certificate of compliance under section 363A.36 revoked or suspended based on the provisions of section 363A.36, with the revocation or suspension becoming final because it was upheld by the Office of Administrative Hearings or was not appealed to the office;*
(5)	The contractor or related entity has not received a final determination assessing a monetary sanction from the Department of Administration or Transportation for failure to meet targeted group business, disadvantaged business enterprise, or veteran-owned business goals, due to a lack of good faith effort, more than once during the three-year period before submitting the verification;*
	*Any violations, suspensions, revocations, or sanctions, as defined in clauses (2) to (5), occurring prior to July 1, 2014, shall not be considered in determining whether a contractor or related entity meets the minimum criteria.
(6)	The contractor or related entity is not currently suspended or debarred by the federal government or the state of Minnesota or any of its departments, commissions, agencies, or political subdivisions that have authority to debar a contractor; and
(7)	All subcontractors and motor carriers that the contractor intends to use to perform project work have verified to the contractor through a signed statement under oath by an owner or officer that they meet the minimum criteria listed in clauses (1) to (6).

Minn. Stat. § 16C.285, Subd. 5. **SUBCONTRACTOR VERIFICATION.**

A prime contractor or subcontractor shall include in its verification of compliance under subdivision 4 a list of all of its first-tier subcontractors that it intends to retain for work on the project. Prior to execution of a construction contract, and as a condition precedent to the execution of a construction contract, the apparent successful prime contractor shall submit to the contracting authority a supplemental verification under oath confirming compliance with subdivision 3, clause (7). Each contractor or subcontractor shall obtain from all subcontractors with which it will have a direct contractual relationship a signed statement under oath by an owner or officer verifying that they meet all of the minimum criteria in subdivision 3 prior to execution of a construction contract with each subcontractor.

If a prime contractor or any subcontractor retains additional subcontractors on the project after submitting its verification of compliance, the prime contractor or subcontractor shall obtain verifications of compliance from each additional subcontractor with which it has a direct contractual relationship and shall submit a supplemental verification confirming compliance with subdivision 3, clause (7), within 14 days of retaining the additional subcontractors.

A prime contractor shall submit to the contracting authority upon request copies of the signed verifications of compliance from all subcontractors of any tier pursuant to subdivision 3, clause (7). A prime contractor and subcontractors shall not be responsible for the false statements of any subcontractor with which they do not have a direct contractual relationship. A prime contractor and subcontractors shall be responsible for false statements by their first-tier subcontractors with which they have a direct contractual relationship only if they accept the verification of compliance with actual knowledge that it contains a false statement.

Subd. 5a. Motor carrier verification. A prime contractor or subcontractor shall obtain annually from all motor carriers with which it will have a direct contractual relationship a signed statement under oath by an owner or officer verifying that they meet all of the minimum criteria in subdivision 3 prior to execution of a construction contract with each motor carrier. A prime contractor or subcontractor shall require each such motor carrier to provide it with immediate written notification in the event that the motor carrier no longer meets one or more of the minimum criteria in subdivision 3 after submitting its annual verification. A motor carrier shall be ineligible to perform work on a project covered by this section if it does not meet all the minimum criteria in subdivision 3. Upon request, a prime contractor

or subcontractor shall submit to the contracting authority the signed verifications of compliance from all motor carriers providing for-hire transportation of materials, equipment, or supplies for a project.

Minn. Stat. § 16C.285, Subd. 4. **VERIFICATION OF COMPLIANCE.**

A contractor responding to a solicitation document of a contracting authority shall submit to the contracting authority a signed statement under oath by an owner or officer verifying compliance with each of the minimum criteria in subdivision 3, with the exception of clause (7), at the time that it responds to the solicitation document.

A contracting authority may accept a signed statement under oath as sufficient to demonstrate that a contractor is a responsible contractor and shall not be held liable for awarding a contract in reasonable reliance on that statement. A prime contractor, subcontractor, or motor carrier that fails to verify compliance with any one of the required minimum criteria or makes a false statement under oath in a verification of compliance shall be ineligible to be awarded a construction contract on the project for which the verification was submitted.

A false statement under oath verifying compliance with any of the minimum criteria may result in termination of a construction contract that has already been awarded to a prime contractor or subcontractor or motor carrier that submits a false statement. A contracting authority shall not be liable for declining to award a contract or terminating a contract based on a reasonable determination that the contractor failed to verify compliance with the minimum criteria or falsely stated that it meets the minimum criteria. A verification of compliance need not be notarized. An electronic verification of compliance made and submitted as part of an electronic bid shall be an acceptable verification of compliance under this section provided that it contains an electronic signature as defined in section 325L.02, paragraph (h).

**CERTIFICATION**

**By signing this document I certify that I am an owner or officer of the company, and I certify under oath that:**

- 1) My company meets each of the Minimum Criteria to be a responsible contractor as defined herein and is in compliance with Minn. Stat. § 16C.285, and**
- 2) if my company is awarded a contract, I will submit Attachment A-1 prior to contract execution, and**
- 3) if my company is awarded a contract, I will also submit Attachment A-2 as required.**

Authorized Signature of Owner or Officer:

Printed Name:

Title:

Date:

Company Name:

NOTE: Minn. Stat. § 16C.285, Subd. 2, (c) If only one prime contractor responds to a solicitation document, a contracting authority may award a construction contract to the responding prime contractor even if the minimum criteria in subdivision 3 are not met.

This document is a MODIFIED version of the MnDOT Responsible Contractor Verification and Certification of Compliance form

Lower Minnesota River Watershed District - OT1.129866

RESPONSIBLE CONTRACTOR VERIFICATION AND  
CERTIFICATION OF COMPLIANCE

February 21, 2024

PAGE 00 45 11-3

\*\*\*\*END OF SECTION\*\*\*\*

---

This document is a MODIFIED version of the MnDOT Responsible Contractor Verification and Certification of Compliance form

Lower Minnesota River Watershed District - OT1.129866

RESPONSIBLE CONTRACTOR VERIFICATION AND  
CERTIFICATION OF COMPLIANCE

February 21, 2024

PAGE 00 45 11-4



Items to Be Executed After Bid Opening  
for  
Vernon Avenue Improvements  
OT1.129866

Lower Minnesota River Watershed District  
Savage, MN



(The Low Bidder May Be Requested to Provide This Information After  
the Bids Are Received But Prior to Issuing the Notice of Award)

## BIDDERS QUALIFICATIONS

### GENERAL INFORMATION

The low bidder is requested to furnish the following information. Additional sheets shall be attached as required.

Contractor's name and address: \_\_\_\_\_  
\_\_\_\_\_  
\_\_\_\_\_

Number of years as a Contractor in construction work of this type: \_\_\_\_\_

Names and titles of all officers of Contractor's firm: \_\_\_\_\_

SUBMIT a list of three construction contracts completed by the Contractor during the last five years involving work of similar type and comparable value. The list shall include the following information as a minimum:

- Name, address, and telephone number of owner.
- Name of project.
- Location of project.
- Brief description of the work involved.
- Contract amount.
- Date of completion of contract.
- Name, address and telephone number of architect or engineer.
- Name of owner's project engineer.

### EQUIPMENT/MATERIAL SOURCE INFORMATION

The low bidder is requested to list the name of the manufacturer or supplier and catalog numbers of the equipment or material proposed to be furnished under the bid. Awarding of a contract under this bid will not imply approval by the Owner of the manufacturers or suppliers listed by the low bidder.

- Plant Mix Bituminous
- Aggregates

\*\*\*\*END OF SECTION\*\*\*\*



# NOTICE OF AWARD

Date of Issuance:

Owner: Lower Minnesota River Watershed District  
Owner's Project No.:  
Engineer: Bolton & Menk, Inc. Engineer's Project No.: OT1.129866  
Project: Vernon Avenue Improvements  
Contract Name:  
Bidder:  
Bidder's Address:

You are notified that Owner has accepted your Bid dated \_\_\_\_\_ for the above Contract, and that you are the Successful Bidder and are awarded a Contract for:

- Vernon Avenue Improvements

The Contract Price of the awarded Contract is \$\_\_\_\_\_. Contract Price is subject to adjustment based on the provisions of the Contract, including but not limited to those governing changes, Unit Price Work, and Work performed on a cost-plus-fee basis, as applicable.

4 unexecuted counterparts of the Agreement accompany this Notice of Award, and one copy of the Contract Documents accompanies this Notice of Award or has been transmitted or made available to Bidder electronically.

Drawings will be delivered separately from the other Contract Documents.

You must comply with the following conditions precedent within 15 days of the date of receipt of this Notice of Award:

1. Deliver to Owner 4 counterparts of the Agreement, signed by Bidder (as Contractor).
2. Deliver with the signed Agreement(s) the Contract security (such as required performance and payment bonds) and insurance documentation, as specified in the Instructions to Bidders and in the General Conditions, Articles 2 and 6.
3. Deliver to Owner executed Section 00 51 11 "ADDITIONAL SUBCONTRACTORS LIST" in accordance with Minn. Stat. 16C.285 subd.3 Subclauses (1) to (7). Delivery is a condition precedent to execution of this contract and failure to submit this form shall be cause for the Owner to cancel Award of Contract and declare your Bid security forfeited.
4. Other conditions precedent (if any): [Describe other conditions that require Successful Bidder's compliance]

Failure to comply with these conditions within the time specified will entitle Owner to consider you in default, annul this Notice of Award, and declare your Bid security forfeited.

Within 10 days after you comply with the above conditions, Owner will return to you one fully signed counterpart of the Agreement, together with any additional copies of the Contract Documents as indicated in Paragraph 2.02 of the General Conditions.

Owner: Lower Minnesota River Watershed District

By (signature): \_\_\_\_\_

Name (printed): \_\_\_\_\_

Title: \_\_\_\_\_

Copy: Engineer

This document is a MODIFIED version of EJCDC® C-510, Copyright© 2018 by NSPE, ACEC, and ASCE. All rights reserved.



**RESPONSIBLE CONTRACTOR VERIFICATION AND CERTIFICATION OF COMPLIANCE  
ATTACHMENT A-1  
FIRST-TIER SUBCONTRACTORS LIST**

**SUBMIT PRIOR TO EXECUTION OF A CONSTRUCTION CONTRACT**

**PROJECT NUMBER: OT1.129866**

Minn. Stat. § 16C.285, Subd. 5. A prime contractor or subcontractor shall include in its verification of compliance under subdivision 4 a list of all of its first-tier subcontractors that it intends to retain for work on the project. Prior to execution of a construction contract, and as a condition precedent to the execution of a construction contract, the apparent successful prime contractor shall submit to the contracting authority a supplemental verification under oath confirming compliance with subdivision 3, clause (7). Each contractor or subcontractor shall obtain from all subcontractors with which it will have a direct contractual relationship a signed statement under oath by an owner or officer verifying that they meet all of the minimum criteria in subdivision 3 prior to execution of a construction contract with each subcontractor.

<b>FIRST TIER SUBCONTRACTOR NAMES* (Legal name of company as registered with the Secretary of State)</b>	<b>Name of city where company home office is located</b>

\*Attach additional sheets as needed for submission of all first-tier subcontractors.

<b>SUPPLEMENTAL CERTIFICATION FOR ATTACHMENT A-1</b>	
By signing this document I certify that I am an owner or officer of the company, and I certify under oath that: All first-tier subcontractors listed on attachment A-1 have verified through a signed statement under oath by an owner or officer that they meet the minimum criteria to be a responsible contractor as defined in Minn. Stat. § 16C.285.	
<b>Authorized Signature of Owner or Officer:</b>	<b>Printed Name:</b>
<b>Title:</b>	<b>Date:</b>
<b>Company Name:</b>	

**ADDITIONAL SUBCONTRACTORS LIST  
ATTACHMENT A-2  
ADDITIONAL SUBCONTRACTORS LIST**

**PRIME CONTRACTOR TO SUBMIT AS SUBCONTRACTORS ARE ADDED TO THE PROJECT  
PROJECT NUMBER: OT1.129866**

This form must be submitted to the Project Manager or individual as identified in the solicitation document.

Minn. Stat. § 16C.285, Subd. 5. If a prime contractor or any subcontractor retains additional subcontractors on the project after submitting its verification of compliance, the prime contractor or subcontractor shall obtain verifications of compliance from each additional subcontractor with which it has a direct contractual relationship and shall submit a supplemental verification confirming compliance with subdivision 3, clause (7), within 14 days of retaining the additional subcontractors.

<b>ADDITIONAL SUBCONTRACTOR NAMES* (Legal name of company as registered with the Secretary of State)</b>	<b>Name of city where company home office is located</b>

\*Attach additional sheets as needed for submission of all additional subcontractors.

<b>SUPPLEMENTAL CERTIFICATION FOR ATTACHMENT A-2</b>	
<b>By signing this document I certify that I am an owner or officer of the company, and I certify under oath that: All additional subcontractors listed on Attachment A-2 have verified through a signed statement under oath by an owner or officer that they meet the minimum criteria to be a responsible contractor as defined in Minn. Stat. § 16C.285.</b>	
<b>Authorized Signature of Owner or Officer:</b>	<b>Printed Name:</b>
<b>Title:</b>	<b>Date:</b>
<b>Company Name:</b>	



# AGREEMENT FORMS

This Agreement is by and between Lower Minnesota River Watershed District (“Owner”) and \_\_\_\_\_ (“Contractor”).

Terms used in this Agreement have the meanings stated in the General Conditions and the Supplementary Conditions.

Owner and Contractor hereby agree as follows:

## ARTICLE 1—WORK

1.01 Contractor shall complete all Work as specified or indicated in the Contract Documents. The Work is generally described as follows:

- Project OT1.129866 - Vernon Avenue Improvements

## ARTICLE 2—THE PROJECT

2.01 The Project, of which the Work under the Contract Documents is a part, is generally described as follows:

- Vernon Avenue Improvements

## ARTICLE 3—ENGINEER

3.01 The Owner has retained Bolton & Menk, Inc. (“Engineer”) to act as Owner’s representative, assume all duties and responsibilities of Engineer, and have the rights and authority assigned to Engineer in the Contract.

3.02 The part of the Project that pertains to the Work has been designed by Bolton & Menk, Inc.

## ARTICLE 4—CONTRACT TIMES

4.01 Time Is of The Essence

- A. All time limits for Milestones, if any, Substantial Completion, and completion and readiness for final payment as stated in the Contract Documents are of the essence of the Contract.

4.02 Substantial Completion

- A. Substantial completion shall be defined as:
1. The date when all work under the contract with the exception of minor punchlist items and final clean up.
  2. The Contractor acknowledges that ongoing inspections are required until the conditions of all construction permits for this project are met and specifically during the following work activities: excavation, backfilling, underground utilities including water, sanitary, and storm sewer, compaction, aggregate base, paving, and removal of all traffic control signage and erosion control temporary best management practices.

4.03 Contract Times: Dates

- A. The work will be substantially completed on or before 09/27/2024, and completed and ready for final payment in accordance with Paragraph 15.06 of Section 00 72 00 “General Conditions” of this Project Manual on or before 10/11/2024.

4.04 Milestones

- A. Parts of the Work must be substantially completed on or before the following Milestone(s):

This document is a MODIFIED version of EJCDC® C-520, Copyright© 2018 by NSPE, ACEC, and ASCE. All rights reserved.

1. **The work must reach substantial completion within 42 calendar days of commencement of earth disturbing activities; and final completion within 14 calendar days of substantial completion, unless otherwise approved by the Engineer in writing.**

#### 4.05 Liquidated Damages

- A. Contractor and Owner recognize that time is of the essence as stated in Paragraph 4.01 above and that Owner will suffer financial and other losses if the Work is not completed and Milestones not achieved within the Contract Times, as duly modified. The parties also recognize the delays, expense, and difficulties involved in proving, in a legal or arbitration proceeding, the actual loss suffered by Owner if the Work is not completed on time. Accordingly, instead of requiring any such proof, Owner and Contractor agree that as liquidated damages for delay (but not as a penalty):
  1. Substantial Completion: Contractor shall pay Owner \$1,500.00 for each day that expires after the time (as duly adjusted pursuant to the Contract) specified above for Substantial Completion, until the Work is substantially complete.
  2. Completion of Remaining Work: After Substantial Completion, if Contractor shall neglect, refuse, or fail to complete the remaining Work within the Contract Times (as duly adjusted pursuant to the Contract) for completion and readiness for final payment, Contractor shall pay Owner \$350.00 for each day that expires after such time until the Work is completed and ready for final payment.
  3. Milestones: Contractor shall pay Owner \$1,500.00 for each day that expires after the time (as duly adjusted pursuant to the Contract) specified above for achievement of Milestone 1, until Milestone 1 is achieved, or until the time specified for Substantial Completion is reached, at which time the rate indicated in Paragraph 4.05.A.1 will apply, rather than the Milestone rate.
  4. Liquidated damages for failing to timely attain completion are not additive and will not be imposed concurrently.
- B. If Owner recovers liquidated damages for a delay in completion by Contractor, then such liquidated damages are Owner's sole and exclusive remedy for such delay, and Owner is precluded from recovering any other damages, whether actual, direct, excess, or consequential, for such delay, except for special damages (if any) specified in this Agreement.

#### ARTICLE 5—CONTRACT PRICE

- 5.01 Owner shall pay Contractor for completion of the Work in accordance with the Contract Documents, the amounts that follow, subject to adjustment under the Contract:
  - A. For all Unit Price Work, an amount equal to the sum of the extended prices (established for each separately identified item of Unit Price Work by multiplying the unit price times the actual quantity of that item).
  - B. The extended prices for Unit Price Work set forth as of the Effective Date of the Contract are based on estimated quantities. As provided in Paragraph 13.03 of the General Conditions, estimated quantities are not guaranteed, and determinations of actual quantities and classifications are to be made by Engineer.
  - C. For all awarded Work, at the prices stated in Contractor's Bid, attached hereto as an exhibit.
  - D. The Work awarded shall include:
    1. Base Bid

This document is a MODIFIED version of EJDC® C-520, Copyright© 2018 by NSPE, ACEC, and ASCE. All rights reserved.

## ARTICLE 6—PAYMENT PROCEDURES

### 6.01 Submittal and Processing of Payments

- A. Applications for Payment shall be submitted and processed in accordance with Article 15 of the General Conditions or as modified by the Supplemental Conditions.

### 6.02 Progress Payments; Retainage

- A. Owner shall make progress payments during performance of the work on the basis of Contractor's Applications for Payment dated on or about the 30th day of each month of the Work as provided in Paragraph 6.02.A.1 below, provided that such Applications for Payment have been submitted in a timely manner and otherwise meet the requirements of the Contract. All such payments will be measured by the Schedule of Values established as provided in the General Conditions (and in the case of Unit Price Work based on the number of units completed) or, in the event there is no Schedule of Values, as provided elsewhere in the Contract.
  - 1. Prior to Substantial Completion, progress payments will be made in an amount equal to the percentage indicated below but, in each case, less the aggregate of payments previously made and less such amounts as Owner may withhold, including but not limited to liquidated damages, in accordance with the Contract.
    - a. 95% percent of the value of the Work completed (with the balance being retainage).
    - b. 95% percent of cost of materials and equipment not incorporated in the Work (with the balance being retainage).
- B. Within 60 days of the date of Substantial Completion, Owner shall pay an amount sufficient to increase total payments to Contractor to 99 percent of the Work completed, less such amounts set off by Owner pursuant to Paragraph 15.01.E of the General Conditions, and less 250 percent of Engineer's estimate of the value of Work to be completed or corrected as shown on the punch list of items to be completed or corrected prior to final payment and all final paperwork is completed. Final paperwork is defined as documents required by the contract which may include but are not limited to:
  - 1. Operations Manuals, as built drawings, and submittals required by the contract documents, and
  - 2. Payroll documents for projects with prevailing wage requirements, and
  - 3. IC 134, and
  - 4. Lien Releases, if required.
    - a. Mn Department of Commerce Form 40.5.1.
    - b. <http://www.commerce.state.mn.us/UCB/40.5.1.pdf> or equal.

### 6.03 Progress Payment to Subcontractors

- A. For contracts within the State of Minnesota, MN Statute 471.425 Subd. 4a. shall apply. MN Statute 471.425 Subd. 4a. requires:
  - 1. The prime contractor shall pay any subcontractor within ten days of the prime contractor's receipt of payment for undisputed services provided by the subcontractor.
  - 2. The prime contractor shall pay interest of 1-1/2 percent per month or any part of a month to the subcontractor on any undisputed amount not paid on time to the subcontractor.

---

This document is a MODIFIED version of EJCDC® C-520, Copyright© 2018 by NSPE, ACEC, and ASCE. All rights reserved.

3. The minimum monthly interest penalty payment for an unpaid balance of \$100 or more is \$10. For an unpaid balance of less than \$100, the prime contractor shall pay the actual penalty due to the subcontractor.
4. A subcontractor who prevails in a civil action to collect interest penalties from a prime contractor must be awarded its costs and disbursements, including attorney's fees, incurred in bringing the action."

6.04 Final Payment

- A. Upon final completion and acceptance of the Work, Owner shall pay the remainder of the Contract Price in accordance with Paragraph 15.06 of the General Conditions.

6.05 Consent of Surety

- A. Owner will not make final payment or return or release retainage at Substantial Completion or any other time, unless Contractor submits written consent of the surety to such payment, return, or release.

6.06 Interest

- A. All amounts not paid when due will bear interest at the rate of 1.5 percent per month.

**ARTICLE 7—CONTRACT DOCUMENTS**

7.01 Contents

- A. The Contract Documents consist of all the following:
  1. This Agreement.
  2. Bonds:
    - a. Performance bond (together with power of attorney).
    - b. Payment bond (together with power of attorney).
  3. General Conditions.
  4. Supplementary Conditions.
  5. Specifications as listed in the table of contents of the project manual (copy of list attached).
  6. Drawings as listed in the table of contents of the project manual (copy of list attached.)
  7. \_\_\_\_\_
  8. Addenda (numbers \_\_\_ to \_\_\_, inclusive).
  9. Exhibits to this Agreement (enumerated as follows):
    - a. Contractor's Bid (pages \_\_\_ to \_\_\_, inclusive).
  10. The following which may be delivered or issued on or after the Effective Date of the Contract and are not attached hereto:
    - a. Notice to Proceed.
    - b. Work Change Directives.
    - c. Change Orders.
    - d. Field Orders.

---

This document is a MODIFIED version of EJCDC® C-520, Copyright© 2018 by NSPE, ACEC, and ASCE. All rights reserved.

- e. Warranty Bond, if any.
- B. The Contract Documents listed in Paragraph 7.01.A are attached to this Agreement (except as expressly noted otherwise above).
- C. There are no Contract Documents other than those listed above in this Article 7.
- D. The Contract Documents may only be amended, modified, or supplemented as provided in the Contract.

## **ARTICLE 8—REPRESENTATIONS, CERTIFICATIONS, AND STIPULATIONS**

### **8.01 Contractor's Representations**

- A. In order to induce Owner to enter into this Contract, Contractor makes the following representations:
  - 1. Contractor has examined and carefully studied the Contract Documents, including Addenda.
  - 2. Contractor has visited the Site, conducted a thorough visual examination of the Site and adjacent areas, and become familiar with the general, local, and Site conditions that may affect cost, progress, and performance of the Work.
  - 3. Contractor is familiar with all Laws and Regulations that may affect cost, progress, and performance of the Work.
  - 4. Contractor has carefully studied the reports of explorations and tests of subsurface conditions at or adjacent to the Site and the drawings of physical conditions relating to existing surface or subsurface structures at the Site that have been identified in the Supplementary Conditions, with respect to the Technical Data in such reports and drawings.
  - 5. Contractor has carefully studied the reports and drawings relating to Hazardous Environmental Conditions, if any, at or adjacent to the Site that have been identified in the Supplementary Conditions, with respect to Technical Data in such reports and drawings.
  - 6. Contractor has considered the information known to Contractor itself; information commonly known to contractors doing business in the locality of the Site; information and observations obtained from visits to the Site; the Contract Documents; and the Technical Data identified in the Supplementary Conditions or by definition, with respect to the effect of such information, observations, and Technical Data on (a) the cost, progress, and performance of the Work; (b) the means, methods, techniques, sequences, and procedures of construction to be employed by Contractor; and (c) Contractor's safety precautions and programs.
  - 7. Based on the information and observations referred to in the preceding paragraph, Contractor agrees that no further examinations, investigations, explorations, tests, studies, or data are necessary for the performance of the Work at the Contract Price, within the Contract Times, and in accordance with the other terms and conditions of the Contract.
  - 8. Contractor is aware of the general nature of work to be performed by Owner and others at the Site that relates to the Work as indicated in the Contract Documents.
  - 9. Contractor has given Engineer written notice of all conflicts, errors, ambiguities, or discrepancies that Contractor has discovered in the Contract Documents, and of discrepancies between Site conditions and the Contract Documents, and the written resolution thereof by Engineer is acceptable to Contractor.
  - 10. The Contract Documents are generally sufficient to indicate and convey understanding of all terms and conditions for performance and furnishing of the Work.

---

This document is a MODIFIED version of EJCDC® C-520, Copyright© 2018 by NSPE, ACEC, and ASCE. All rights reserved.

11. Contractor's entry into this Contract constitutes an incontrovertible representation by Contractor that without exception all prices in the Agreement are premised upon performing and furnishing the Work required by the Contract Documents.

#### 8.02 Contractor's Certifications

- A. Contractor certifies that it has not engaged in corrupt, fraudulent, collusive, or coercive practices in competing for or in executing the Contract. For the purposes of this Paragraph 8.02:
  1. "corrupt practice" means the offering, giving, receiving, or soliciting of anything of value likely to influence the action of a public official in the bidding process or in the Contract execution;
  2. "fraudulent practice" means an intentional misrepresentation of facts made (a) to influence the bidding process or the execution of the Contract to the detriment of Owner, (b) to establish Bid or Contract prices at artificial non-competitive levels, or (c) to deprive Owner of the benefits of free and open competition;
  3. "collusive practice" means a scheme or arrangement between two or more Bidders, with or without the knowledge of Owner, a purpose of which is to establish Bid prices at artificial, non-competitive levels; and
  4. "coercive practice" means harming or threatening to harm, directly or indirectly, persons or their property to influence their participation in the bidding process or affect the execution of the Contract.

#### 8.03 Standard General Conditions

- A. Owner stipulates that if the General Conditions that are made a part of this Contract are EJCDC® C 700, Standard General Conditions for the Construction Contract (2018), published by the Engineers Joint Contract Documents Committee, and if Owner is the party that has furnished said General Conditions, then Owner has plainly shown all modifications to the standard wording of such published document to the Contractor, through a process such as highlighting or "track changes" (redline/strikeout), or in the Supplementary Conditions.

IN WITNESS WHEREOF, Owner and Contractor have signed this Agreement.

This Agreement will be effective on \_\_\_\_\_ (which is the Effective Date of the Contract).

OWNER:

CONTRACTOR:

Lower Minnesota River Watershed District  
*(typed or printed name of organization)*

\_\_\_\_\_  
*(typed or printed name of organization)*

By: \_\_\_\_\_  
*(individual's signature)*

By: \_\_\_\_\_  
*(individual's signature)*

Date: \_\_\_\_\_  
*(date signed)*

Date: \_\_\_\_\_  
*(date signed)*

Name: \_\_\_\_\_  
*(typed or printed)*

Name: \_\_\_\_\_  
*(typed or printed)*

Title: \_\_\_\_\_  
*(typed or printed)*

Title: \_\_\_\_\_  
*(typed or printed)*

*(If Contractor is a corporation, a partnership, or a joint venture, attach evidence of authority to sign.)*

Attest: \_\_\_\_\_  
*(individual's signature)*

Attest: \_\_\_\_\_  
*(individual's signature)*

Title: \_\_\_\_\_  
*(typed or printed)*

Title: \_\_\_\_\_  
*(typed or printed)*

Address for giving notices:

112 E. 5th St, Suite #102

Chaska, MN 55318

Address for giving notices:

Designated Representative:

Designated Representative

Name: \_\_\_\_\_  
*(typed or printed)*

Name: \_\_\_\_\_  
*(typed or printed)*

Title: \_\_\_\_\_  
*(typed or printed)*

Title: \_\_\_\_\_  
*(typed or printed)*

Address:

Address:

# NOTICE TO PROCEED

Owner: Lower Minnesota River Watershed Owner's Project No.: \_\_\_\_\_  
Engineer: Bolton & Menk, Inc. Engineer's Project No.: 0T1.129866  
Contractor: \_\_\_\_\_ Contractor's Project No.: \_\_\_\_\_  
Project: Vernon Avenue Improvements  
Contract Name: \_\_\_\_\_  
Effective Date of Contract: \_\_\_\_\_

Owner hereby notifies Contractor that the Contract Times under the above Contract will commence to run on \_\_\_\_\_ pursuant to Paragraph 4.01 of the General Conditions.

On that date, Contractor shall start performing its obligations under the Contract Documents. No Work will be done at the Site prior to such date.

The Substantial Completion and Final Completion must be achieved in accordance with the requirements of the Agreement.

Before starting any Work at the Site, Contractor must comply with the following: None

Owner: Lower Minnesota River Watershed District

By (signature): \_\_\_\_\_

Name (printed): \_\_\_\_\_

Title: \_\_\_\_\_

Date Issued: \_\_\_\_\_

Copy: Engineer



## PERFORMANCE BOND FORM

<p><b>Contractor</b></p> <p>Name: _____</p> <p>Address <i>(principal place of business)</i>: _____</p>	<p><b>Surety</b></p> <p>Name: _____</p> <p>Address <i>(principal place of business)</i>: _____</p>
<p><b>Owner</b></p> <p>Name: Lower Minnesota River Watershed District</p> <p>Mailing address <i>(principal place of business)</i>: 112 E. 5th St, Suite #102 Chaska, MN 55318</p>	<p><b>Contract</b></p> <p>Description <i>(name and location)</i>: Vernon Avenue Improvements</p> <p>Contract Price: _____</p> <p>Effective Date of Contract: _____</p>
<p><b>Bond</b></p> <p>Bond Amount: _____</p> <p>Date of Bond: _____ <i>(Date of Bond cannot be earlier than Effective Date of Contract)</i></p> <p>Modifications to this Bond form: <input type="checkbox"/> None <input type="checkbox"/> See Paragraph 16</p>	
<p>Surety and Contractor, intending to be legally bound hereby, subject to the terms set forth in this Performance Bond, do each cause this Performance Bond to be duly executed by an authorized officer, agent, or representative.</p>	
Contractor as Principal	Surety
_____ <i>(Full formal name of Contractor)</i>	_____ <i>(Full formal name of Surety) (corporate seal)</i>
By: _____ <i>(Signature)</i>	By: _____ <i>(Signature)(Attach Power of Attorney)</i>
Name: _____ <i>(Printed or typed)</i>	Name: _____ <i>(Printed or typed)</i>
Title: _____	Title: _____
Attest: _____ <i>(Signature)</i>	Attest: _____ <i>(Signature)</i>
Name: _____ <i>(Printed or typed)</i>	Name: _____ <i>(Printed or typed)</i>
Title: _____	Title: _____
<p><i>Notes: (1) Provide supplemental execution by any additional parties, such as joint venturers. (2) Any singular reference to Contractor, Surety, Owner, or other party is considered plural where applicable.</i></p>	

This document is a MODIFIED version of EJCDC® C-610, Copyright© 2018 by NSPE, ACEC, and ASCE. All rights reserved.

1. The Contractor and Surety, jointly and severally, bind themselves, their heirs, executors, administrators, successors, and assigns to the Owner for the performance of the Construction Contract, which is incorporated herein by reference.
2. If the Contractor performs the Construction Contract, the Surety and the Contractor shall have no obligation under this Bond, except when applicable to participate in a conference as provided in Paragraph 3.
3. If there is no Owner Default under the Construction Contract, the Surety's obligation under this Bond will arise after:
  - 3.1. The Owner first provides notice to the Contractor and the Surety that the Owner is considering declaring a Contractor Default. Such notice may indicate whether the Owner is requesting a conference among the Owner, Contractor, and Surety to discuss the Contractor's performance. If the Owner does not request a conference, the Surety may, within five (5) business days after receipt of the Owner's notice, request such a conference. If the Surety timely requests a conference, the Owner shall attend. Unless the Owner agrees otherwise, any conference requested under this Paragraph 3.1 will be held within ten (10) business days of the Surety's receipt of the Owner's notice. If the Owner, the Contractor, and the Surety agree, the Contractor shall be allowed a reasonable time to perform the Construction Contract, but such an agreement does not waive the Owner's right, if any, subsequently to declare a Contractor Default;
  - 3.2. The Owner declares a Contractor Default, terminates the Construction Contract, and notifies the Surety; and
  - 3.3. The Owner has agreed to pay the Balance of the Contract Price in accordance with the terms of the Construction Contract to the Surety or to a contractor selected to perform the Construction Contract.
4. Failure on the part of the Owner to comply with the notice requirement in Paragraph 3.1 does not constitute a failure to comply with a condition precedent to the Surety's obligations, or release the Surety from its obligations, except to the extent the Surety demonstrates actual prejudice.
5. When the Owner has satisfied the conditions of Paragraph 3, the Surety shall promptly and at the Surety's expense take one of the following actions:
  - 5.1. Arrange for the Contractor, with the consent of the Owner, to perform and complete the Construction Contract;
  - 5.2. Undertake to perform and complete the Construction Contract itself, through its agents or independent contractors;
  - 5.3. Obtain bids or negotiated proposals from qualified contractors acceptable to the Owner for a contract for performance and completion of the Construction Contract, arrange for a contract to be prepared for execution by the Owner and a contractor selected with the Owners concurrence, to be secured with performance and payment bonds executed by a qualified surety equivalent to the bonds issued on the Construction Contract, and pay to the Owner the amount of damages as described in Paragraph 7 in excess of the Balance of the Contract Price incurred by the Owner as a result of the Contractor Default; or
  - 5.4. Waive its right to perform and complete, arrange for completion, or obtain a new contractor, and with reasonable promptness under the circumstances:

5.4.1 After investigation, determine the amount for which it may be liable to the Owner and, as soon as practicable after the amount is determined, make payment to the Owner; or

5.4.2 Deny liability in whole or in part and notify the Owner, citing the reasons for denial.

6. If the Surety does not proceed as provided in Paragraph 5 with reasonable promptness, the Surety shall be deemed to be in default on this Bond seven days after receipt of an additional written notice from the Owner to the Surety demanding that the Surety perform its obligations under this Bond, and the Owner shall be entitled to enforce any remedy available to the Owner. If the Surety proceeds as provided in Paragraph 5.4, and the Owner refuses the payment, or the Surety has denied liability, in whole or in part, without further notice, the Owner shall be entitled to enforce any remedy available to the Owner.
7. If the Surety elects to act under Paragraph 5.1, 5.2, or 5.3, then the responsibilities of the Surety to the Owner will not be greater than those of the Contractor under the Construction Contract, and the responsibilities of the Owner to the Surety will not be greater than those of the Owner under the Construction Contract. Subject to the commitment by the Owner to pay the Balance of the Contract Price, the Surety is obligated, without duplication for:
  - 7.1. the responsibilities of the Contractor for correction of defective work and completion of the Construction Contract;
  - 7.2. additional legal, design professional, and delay costs resulting from the Contractor's Default, and resulting from the actions or failure to act of the Surety under Paragraph 5; and
  - 7.3. liquidated damages, or if no liquidated damages are specified in the Construction Contract, actual damages caused by delayed performance or non-performance of the Contractor.
8. If the Surety elects to act under Paragraph 5.1, 5.3, or 5.4, the Surety's liability is limited to the amount of this Bond.
9. The Surety shall not be liable to the Owner or others for obligations of the Contractor that are unrelated to the Construction Contract, and the Balance of the Contract Price will not be reduced or set off on account of any such unrelated obligations. No right of action will accrue on this Bond to any person or entity other than the Owner or its heirs, executors, administrators, successors, and assigns.
10. The Surety hereby waives notice of any change, including changes of time, to the Construction Contract or to related subcontracts, purchase orders, and other obligations.
11. Any proceeding, legal or equitable, under this Bond must be instituted in any court of competent jurisdiction in the location in which the work or part of the work is located and must be instituted within two years after a declaration of Contractor Default or within two years after the Contractor ceased working or within two years after the Surety refuses or fails to perform its obligations under this Bond, whichever occurs first. If the provisions of this paragraph are void or prohibited by law, the minimum periods of limitations available to sureties as a defense in the jurisdiction of the suit will be applicable.
12. Notice to the Surety, the Owner, or the Contractor must be mailed or delivered to the address shown on the page on which their signature appears.
13. When this Bond has been furnished to comply with a statutory or other legal requirement in the location where the construction was to be performed, any provision in this Bond conflicting with said statutory or legal requirement will be deemed deleted therefrom and provisions conforming to such statutory or other legal requirement will be deemed incorporated herein. When so furnished, the intent is that this Bond will be construed as a statutory bond and not as a common law bond.
14. Definitions

---

This document is a MODIFIED version of EJCDC® C-610, Copyright© 2018 by NSPE, ACEC, and ASCE. All rights reserved.

- 14.1. Balance of the Contract Price—The total amount payable by the Owner to the Contractor under the Construction Contract after all proper adjustments have been made including allowance for the Contractor for any amounts received or to be received by the Owner in settlement of insurance or other claims for damages to which the Contractor is entitled, reduced by all valid and proper payments made to or on behalf of the Contractor under the Construction Contract.
- 14.2. Construction Contract—The agreement between the Owner and Contractor identified on the cover page, including all Contract Documents and changes made to the agreement and the Contract Documents.
- 14.3. Contractor Default—Failure of the Contractor, which has not been remedied or waived, to perform or otherwise to comply with a material term of the Construction Contract.
- 14.4. Owner Default—Failure of the Owner, which has not been remedied or waived, to pay the Contractor as required under the Construction Contract or to perform and complete or comply with the other material terms of the Construction Contract.
- 14.5. Contract Documents—All the documents that comprise the agreement between the Owner and Contractor.
15. If this Bond is issued for an agreement between a contractor and subcontractor, the term Contractor in this Bond will be deemed to be Subcontractor and the term Owner will be deemed to be Contractor.
16. Modifications to this Bond are as follows: None

## PAYMENT BOND FORM

<b>Contractor</b> Name: Address <i>(principal place of business)</i> :	<b>Surety</b> Name: Address <i>(principal place of business)</i> :
<b>Owner</b> Lower Minnesota River Watershed Name: District Mailing address <i>(principal place of business)</i> : 112 E. 5th St, Suite #102 Chaska, MN 55318	<b>Contract</b> Description <i>(name and location)</i> : Vernon Avenue Improvements Contract Price: Effective Date of Contract:
<b>Bond</b> Bond Amount: Date of Bond: <i>(Date of Bond cannot be earlier than Effective Date of Contract)</i> Modifications to this Bond form: <input type="checkbox"/> None <input type="checkbox"/> See Paragraph 18	
Surety and Contractor, intending to be legally bound hereby, subject to the terms set forth in this Payment Bond, do each cause this Payment Bond to be duly executed by an authorized officer, agent, or representative.	
Contractor as Principal	Surety
_____ <i>(Full formal name of Contractor)</i>	_____ <i>(Full formal name of Surety) (corporate seal)</i>
By: _____ <span style="margin-left: 100px;"><i>(Signature)</i></span>	By: _____ <span style="margin-left: 100px;"><i>(Signature)(Attach Power of Attorney)</i></span>
Name: _____ <span style="margin-left: 100px;"><i>(Printed or typed)</i></span>	Name: _____ <span style="margin-left: 100px;"><i>(Printed or typed)</i></span>
Title: _____	Title: _____
Attest: _____ <span style="margin-left: 100px;"><i>(Signature)</i></span>	Attest: _____ <span style="margin-left: 100px;"><i>(Signature)</i></span>
Name: _____ <span style="margin-left: 100px;"><i>(Printed or typed)</i></span>	Name: _____ <span style="margin-left: 100px;"><i>(Printed or typed)</i></span>
Title: _____	Title: _____
<i>Notes: (1) Provide supplemental execution by any additional parties, such as joint venturers. (2) Any singular reference to Contractor, Surety, Owner, or other party is considered plural where applicable.</i>	

This document is a MODIFIED version of EJCDC® C-615, Copyright© 2018 by NSPE, ACEC, and ASCE. All rights reserved.

1. The Contractor and Surety, jointly and severally, bind themselves, their heirs, executors, administrators, successors, and assigns to the Owner to pay for labor, materials, and equipment furnished for use in the performance of the Construction Contract, which is incorporated herein by reference, subject to the following terms.
2. If the Contractor promptly makes payment of all sums due to Claimants, and defends, indemnifies, and holds harmless the Owner from claims, demands, liens, or suits by any person or entity seeking payment for labor, materials, or equipment furnished for use in the performance of the Construction Contract, then the Surety and the Contractor shall have no obligation under this Bond.
3. If there is no Owner Default under the Construction Contract, the Surety's obligation to the Owner under this Bond will arise after the Owner has promptly notified the Contractor and the Surety (at the address described in Paragraph 13) of claims, demands, liens, or suits against the Owner or the Owner's property by any person or entity seeking payment for labor, materials, or equipment furnished for use in the performance of the Construction Contract, and tendered defense of such claims, demands, liens, or suits to the Contractor and the Surety.
4. When the Owner has satisfied the conditions in Paragraph 3, the Surety shall promptly and at the Surety's expense defend, indemnify, and hold harmless the Owner against a duly tendered claim, demand, lien, or suit.
5. The Surety's obligations to a Claimant under this Bond will arise after the following:
  - 5.1. Claimants who do not have a direct contract with the Contractor
    - 5.1.1. have furnished a written notice of non-payment to the Contractor, stating with substantial accuracy the amount claimed and the name of the party to whom the materials were, or equipment was, furnished or supplied or for whom the labor was done or performed, within ninety (90) days after having last performed labor or last furnished materials or equipment included in the Claim; and
    - 5.1.2. have sent a Claim to the Surety (at the address described in Paragraph 13).
  - 5.2. Claimants who are employed by or have a direct contract with the Contractor have sent a Claim to the Surety (at the address described in Paragraph 13).
6. If a notice of non-payment required by Paragraph 5.1.1 is given by the Owner to the Contractor, that is sufficient to satisfy a Claimant's obligation to furnish a written notice of non-payment under Paragraph 5.1.1.
7. When a Claimant has satisfied the conditions of Paragraph 5.1 or 5.2, whichever is applicable, the Surety shall promptly and at the Surety's expense take the following actions:
  - 7.1. Send an answer to the Claimant, with a copy to the Owner, within sixty (60) days after receipt of the Claim, stating the amounts that are undisputed and the basis for challenging any amounts that are disputed; and
  - 7.2. Pay or arrange for payment of any undisputed amounts.
  - 7.3. The Surety's failure to discharge its obligations under Paragraph 7.1 or 7.2 will not be deemed to constitute a waiver of defenses the Surety or Contractor may have or acquire as to a Claim, except as to undisputed amounts for which the Surety and Claimant have reached agreement. If, however, the Surety fails to discharge its obligations under Paragraph 7.1 or 7.2, the Surety shall indemnify the Claimant for the reasonable attorney's fees the Claimant incurs thereafter to recover any sums found to be due and owing to the Claimant.

8. The Surety's total obligation will not exceed the amount of this Bond, plus the amount of reasonable attorney's fees provided under Paragraph 7.3, and the amount of this Bond will be credited for any payments made in good faith by the Surety.
9. Amounts owed by the Owner to the Contractor under the Construction Contract will be used for the performance of the Construction Contract and to satisfy claims, if any, under any construction performance bond. By the Contractor furnishing and the Owner accepting this Bond, they agree that all funds earned by the Contractor in the performance of the Construction Contract are dedicated to satisfying obligations of the Contractor and Surety under this Bond, subject to the Owner's priority to use the funds for the completion of the work.
10. The Surety shall not be liable to the Owner, Claimants, or others for obligations of the Contractor that are unrelated to the Construction Contract. The Owner shall not be liable for the payment of any costs or expenses of any Claimant under this Bond and shall have under this Bond no obligation to make payments to or give notice on behalf of Claimants, or otherwise have any obligations to Claimants under this Bond.
11. The Surety hereby waives notice of any change, including changes of time, to the Construction Contract or to related subcontracts, purchase orders, and other obligations.
12. No suit or action will be commenced by a Claimant under this Bond other than in a court of competent jurisdiction in the state in which the project that is the subject of the Construction Contract is located or after the expiration of one year from the date (1) on which the Claimant sent a Claim to the Surety pursuant to Paragraph 5.1.2 or 5.2, or (2) on which the last labor or service was performed by anyone or the last materials or equipment were furnished by anyone under the Construction Contract, whichever of (1) or (2) first occurs. If the provisions of this paragraph are void or prohibited by law, the minimum period of limitation available to sureties as a defense in the jurisdiction of the suit will be applicable.
13. Notice and Claims to the Surety, the Owner, or the Contractor must be mailed or delivered to the address shown on the page on which their signature appears. Actual receipt of notice or Claims, however accomplished, will be sufficient compliance as of the date received.
14. When this Bond has been furnished to comply with a statutory or other legal requirement in the location where the construction was to be performed, any provision in this Bond conflicting with said statutory or legal requirement will be deemed deleted here from and provisions conforming to such statutory or other legal requirement will be deemed incorporated herein. When so furnished, the intent is that this Bond will be construed as a statutory bond and not as a common law bond.
15. Upon requests by any person or entity appearing to be a potential beneficiary of this Bond, the Contractor and Owner shall promptly furnish a copy of this Bond or shall permit a copy to be made.
16. Definitions
  - 16.1. Claim—A written statement by the Claimant including at a minimum:
    - 16.1.1. The name of the Claimant;
    - 16.1.2. The name of the person for whom the labor was done, or materials or equipment furnished;
    - 16.1.3. A copy of the agreement or purchase order pursuant to which labor, materials, or equipment was furnished for use in the performance of the Construction Contract;
    - 16.1.4. A brief description of the labor, materials, or equipment furnished;

- 16.1.5. The date on which the Claimant last performed labor or last furnished materials or equipment for use in the performance of the Construction Contract;
  - 16.1.6. The total amount earned by the Claimant for labor, materials, or equipment furnished as of the date of the Claim;
  - 16.1.7. The total amount of previous payments received by the Claimant; and
  - 16.1.8. The total amount due and unpaid to the Claimant for labor, materials, or equipment furnished as of the date of the Claim.
- 16.2. Claimant—An individual or entity having a direct contract with the Contractor or with a subcontractor of the Contractor to furnish labor, materials, or equipment for use in the performance of the Construction Contract. The term Claimant also includes any individual or entity that has rightfully asserted a claim under an applicable mechanic’s lien or similar statute against the real property upon which the Project is located. The intent of this Bond is to include without limitation in the terms of “labor, materials, or equipment” that part of the water, gas, power, light, heat, oil, gasoline, telephone service, or rental equipment used in the Construction Contract, architectural and engineering services required for performance of the work of the Contractor and the Contractor’s subcontractors, and all other items for which a mechanic’s lien may be asserted in the jurisdiction where the labor, materials, or equipment were furnished.
- 16.3. Construction Contract—The agreement between the Owner and Contractor identified on the cover page, including all Contract Documents and all changes made to the agreement and the Contract Documents.
- 16.4. Owner Default—Failure of the Owner, which has not been remedied or waived, to pay the Contractor as required under the Construction Contract or to perform and complete or comply with the other material terms of the Construction Contract.
- 16.5. Contract Documents—All the documents that comprise the agreement between the Owner and Contractor.
17. If this Bond is issued for an agreement between a contractor and subcontractor, the term Contractor in this Bond will be deemed to be Subcontractor and the term Owner will be deemed to be Contractor.
18. Modifications to this Bond are as follows: **None**



# WARRANTY BOND FORM

<p><b>Contractor</b></p> <p>Name: _____</p> <p>Address (principal place of business): _____</p>	<p><b>Surety</b></p> <p>Name: _____</p> <p>Address (principal place of business): _____</p>
<p><b>Owner</b></p> <p>Name: Lower Minnesota River Watershed District</p> <p>Address (principal place of business): 112 E. 5th St, Suite #102 Chaska, MN 55318</p>	<p><b>Construction Contract</b></p> <p>Description (name and location): Vernon Avenue Improvements</p> <p>Contract Price: _____</p> <p>Effective Date of Contract: _____</p> <p>Contract's Date of Substantial Completion: 09/27/2024</p>
<p><b>Bond</b></p> <p>Bond Amount: _____ Bond Period: Commencing 364 days after Substantial Completion of the Work under the Construction Contract, and continuing until 2 year(s) after such Substantial Completion.</p> <p>Date of Bond: _____</p> <p>Modifications to this Bond form:  <input type="checkbox"/> None <input type="checkbox"/> See Paragraph 9</p>	
<p>Surety and Contractor, intending to be legally bound hereby, subject to the terms set forth herein, do each cause this Warranty Bond to be duly executed by an authorized officer, agent, or representative.</p>	
Contractor as Principal	Surety
_____ <i>(Full formal name of Contractor)</i>	_____ <i>(Full formal name of Surety) (corporate seal)</i>
By: _____ <i>(Signature)</i>	By: _____ <i>(Signature) (Attach Power of Attorney)</i>
Name: _____ <i>(Printed or typed)</i>	Name: _____ <i>(Printed or typed)</i>
Title: _____	Title: _____
Attest: _____ <i>(Signature)</i>	Attest: _____ <i>(Signature)</i>
Name: _____ <i>(Printed or typed)</i>	Name: _____ <i>(Printed or typed)</i>
Title: _____	Title: _____
<p><i>Notes: (1) Provide supplemental execution by any additional parties, such as joint venturers. (2) Any singular reference to Contractor, Surety, Owner, or other party is considered plural where applicable.</i></p>	

This document is a MODIFIED version of EJCDC® C-612, Copyright© 2018 by NSPE, ACEC, and ASCE. All rights reserved.

1. The Contractor and Surety, jointly and severally, bind themselves, their heirs, executors, administrators, successors, and assigns to the Owner for the performance of the Construction Contract's Correction Period Obligations. The Construction Contract is incorporated herein by reference.
2. If the Contractor performs the Correction Period Obligations, the Surety and the Contractor shall have no obligation under this Warranty Bond.
3. If Owner gives written notice to Contractor and Surety during the Bond Period of Contractor's obligation under the Correction Period Obligations, and Contractor does not fulfill such obligation, then Surety shall be responsible for fulfillment of such Correction Period Obligations. Surety shall either fulfill the Correction Period Obligations itself, through its agents or contractors, or, in the alternative, Surety may waive the right to fulfill the Correction Period Obligations itself and reimburse the Owner for all resulting costs incurred by Owner in performing Contractor's Correction Period Obligations, including but not limited to correction, removal, replacement, and repair costs.
4. The Surety's liability is limited to the amount of this Warranty Bond. Renewal or continuation of the Warranty Bond will not modify such amount unless expressly agreed to by Surety in writing.
5. The Surety shall have no liability under this Warranty Bond for obligations of the Contractor that are unrelated to the Construction Contract. No right of action will accrue on this Warranty Bond to any person or entity other than the Owner or its heirs, executors, administrators, successors, and assigns.
6. Any proceeding, legal or equitable, under this Warranty Bond may be instituted in any court of competent jurisdiction in the location in which the Work or part of the Work is located and must be instituted within two years after the Surety refuses or fails to perform its obligations under this Warranty Bond.
7. Written notice to the Surety, the Owner, or the Contractor must be mailed or delivered to the address shown in this Warranty Bond.
8. Definitions
  - 8.1. Construction Contract—The agreement between the Owner and Contractor identified on the cover page of this Warranty Bond, including all Contract Documents and changes made to the agreement and the Contract Documents.
  - 8.2. Contract Documents—All the documents that comprise the agreement between the Owner and Contractor.
  - 8.3. Correction Period Obligations—The duties, responsibilities, commitments, and obligations of the Contractor with respect to correction or replacement of defective Work, as set forth in the Construction Contract's Correction Period clause, EJCDC® C 700, Standard General Conditions of the Construction Contract (2018), Paragraph 15.08, as duly modified.
  - 8.4. Substantial Completion—As defined in the Construction Contract.
  - 8.5. Work—As defined in the Construction Contract.
9. Modifications to this Bond are as follows: **None**

**C-700 2018  
Standard General Conditions  
of the Construction Contract**

**Vernon Avenue Improvements**

**OT1.129866**

**Lower Minnesota River Watershed District**

**Savage, MN**

This document has important legal consequences; consultation with an attorney is encouraged with respect to its use or modification. This document should be adapted to the particular circumstances of the contemplated Project and the controlling Laws and Regulations.

## STANDARD GENERAL CONDITIONS OF THE CONSTRUCTION CONTRACT

Prepared By



Endorsed By



Copyright© 2018

National Society of Professional Engineers  
1420 King Street, Alexandria, VA 22314-2794  
(703) 684-2882  
[www.nspe.org](http://www.nspe.org)

American Council of Engineering Companies  
1015 15th Street N.W., Washington, DC 20005  
(202) 347-7474  
[www.acec.org](http://www.acec.org)

American Society of Civil Engineers  
1801 Alexander Bell Drive, Reston, VA 20191-4400  
(800) 548-2723  
[www.asce.org](http://www.asce.org)

The copyright for this EJCDC document is owned jointly by the three sponsoring organizations listed above. The National Society of Professional Engineers is the Copyright Administrator for the EJCDC documents; please direct all inquiries regarding EJCDC copyrights to NSPE.

NOTE: EJCDC publications may be purchased at [www.ejcdc.org](http://www.ejcdc.org), or from any of the sponsoring organizations above.

# STANDARD GENERAL CONDITIONS OF THE CONSTRUCTION CONTRACT

## TABLE OF CONTENTS

	Page
Article 1—Definitions and Terminology.....	1
1.01 Defined Terms.....	1
1.02 Terminology .....	6
Article 2—Preliminary Matters.....	7
2.01 Delivery of Performance and Payment Bonds; Evidence of Insurance.....	7
2.02 Copies of Documents .....	7
2.03 Before Starting Construction .....	7
2.04 Preconstruction Conference; Designation of Authorized Representatives.....	8
2.05 Acceptance of Schedules .....	8
2.06 Electronic Transmittals .....	8
Article 3—Contract Documents: Intent, Requirements, Reuse.....	9
3.01 Intent.....	9
3.02 Reference Standards.....	9
3.03 Reporting and Resolving Discrepancies .....	10
3.04 Requirements of the Contract Documents.....	10
3.05 Reuse of Documents.....	11
Article 4—Commencement and Progress of the Work .....	11
4.01 Commencement of Contract Times; Notice to Proceed.....	11
4.02 Starting the Work.....	11
4.03 Reference Points .....	11
4.04 Progress Schedule.....	12
4.05 Delays in Contractor’s Progress .....	12
Article 5—Site; Subsurface and Physical Conditions; Hazardous Environmental Conditions .....	13
5.01 Availability of Lands .....	13
5.02 Use of Site and Other Areas.....	14
5.03 Subsurface and Physical Conditions.....	15
5.04 Differing Subsurface or Physical Conditions .....	16

5.05	Underground Facilities .....	17
5.06	Hazardous Environmental Conditions at Site .....	19
Article 6—Bonds and Insurance.....		21
6.01	Performance, Payment, and Other Bonds.....	21
6.02	Insurance—General Provisions.....	22
6.03	Contractor’s Insurance.....	24
6.04	Builder’s Risk and Other Property Insurance.....	25
6.05	Property Losses; Subrogation .....	25
6.06	Receipt and Application of Property Insurance Proceeds .....	27
Article 7—Contractor’s Responsibilities .....		27
7.01	Contractor’s Means and Methods of Construction .....	27
7.02	Supervision and Superintendence .....	27
7.03	Labor; Working Hours .....	27
7.04	Services, Materials, and Equipment .....	28
7.05	“Or Equals”.....	28
7.06	Substitutes .....	29
7.07	Concerning Subcontractors and Suppliers.....	31
7.08	Patent Fees and Royalties.....	32
7.09	Permits .....	33
7.10	Taxes .....	33
7.11	Laws and Regulations.....	33
7.12	Record Documents.....	33
7.13	Safety and Protection .....	34
7.14	Hazard Communication Programs .....	35
7.15	Emergencies.....	35
7.16	Submittals .....	35
7.17	Contractor’s General Warranty and Guarantee .....	38
7.18	Indemnification .....	39
7.19	Delegation of Professional Design Services .....	39
Article 8—Other Work at the Site.....		40
8.01	Other Work .....	40
8.02	Coordination .....	41
8.03	Legal Relationships.....	41

Article 9—Owner’s Responsibilities .....	42
9.01 Communications to Contractor .....	42
9.02 Replacement of Engineer .....	42
9.03 Furnish Data .....	42
9.04 Pay When Due.....	42
9.05 Lands and Easements; Reports, Tests, and Drawings.....	43
9.06 Insurance.....	43
9.07 Change Orders .....	43
9.08 Inspections, Tests, and Approvals.....	43
9.09 Limitations on Owner’s Responsibilities .....	43
9.10 Undisclosed Hazardous Environmental Condition.....	43
9.11 Evidence of Financial Arrangements.....	43
9.12 Safety Programs .....	43
Article 10—Engineer’s Status During Construction .....	44
10.01 Owner’s Representative.....	44
10.02 Visits to Site.....	44
10.03 Resident Project Representative.....	44
10.04 Engineer’s Authority .....	44
10.05 Determinations for Unit Price Work .....	45
10.06 Decisions on Requirements of Contract Documents and Acceptability of Work .....	45
10.07 Limitations on Engineer’s Authority and Responsibilities .....	45
10.08 Compliance with Safety Program.....	45
Article 11—Changes to the Contract .....	46
11.01 Amending and Supplementing the Contract .....	46
11.02 Change Orders .....	46
11.03 Work Change Directives.....	46
11.04 Field Orders.....	47
11.05 Owner-Authorized Changes in the Work .....	47
11.06 Unauthorized Changes in the Work.....	47
11.07 Change of Contract Price .....	47
11.08 Change of Contract Times.....	49
11.09 Change Proposals.....	49
11.10 Notification to Surety.....	50



Article 12—Claims.....	50
12.01    Claims.....	50
Article 13—Cost of the Work; Allowances; Unit Price Work .....	51
13.01    Cost of the Work .....	51
13.02    Allowances .....	55
13.03    Unit Price Work.....	55
Article 14—Tests and Inspections; Correction, Removal, or Acceptance of Defective Work .....	56
14.01    Access to Work.....	56
14.02    Tests, Inspections, and Approvals.....	56
14.03    Defective Work .....	57
14.04    Acceptance of Defective Work.....	58
14.05    Uncovering Work .....	58
14.06    Owner May Stop the Work .....	58
14.07    Owner May Correct Defective Work.....	59
Article 15—Payments to Contractor; Set-Offs; Completion; Correction Period .....	59
15.01    Progress Payments.....	59
15.02    Contractor’s Warranty of Title .....	62
15.03    Substantial Completion.....	62
15.04    Partial Use or Occupancy .....	63
15.05    Final Inspection .....	64
15.06    Final Payment.....	64
15.07    Waiver of Claims .....	65
15.08    Correction Period .....	66
Article 16—Suspension of Work and Termination .....	67
16.01    Owner May Suspend Work .....	67
16.02    Owner May Terminate for Cause.....	67
16.03    Owner May Terminate for Convenience.....	68
16.04    Contractor May Stop Work or Terminate .....	68
Article 17—Final Resolution of Disputes .....	69
17.01    Methods and Procedures.....	69
Article 18—Miscellaneous .....	69
18.01    Giving Notice .....	69
18.02    Computation of Times.....	69

18.03 Cumulative Remedies ..... 70  
18.04 Limitation of Damages ..... 70  
18.05 No Waiver ..... 70  
18.06 Survival of Obligations ..... 70  
18.07 Controlling Law ..... 70  
18.08 Assignment of Contract..... 70  
18.09 Successors and Assigns ..... 70  
18.10 Headings..... 70

# STANDARD GENERAL CONDITIONS OF THE CONSTRUCTION CONTRACT

## ARTICLE 1—DEFINITIONS AND TERMINOLOGY

### 1.01 *Defined Terms*

- A. Wherever used in the Bidding Requirements or Contract Documents, a term printed with initial capital letters, including the term's singular and plural forms, will have the meaning indicated in the definitions below. In addition to terms specifically defined, terms with initial capital letters in the Contract Documents include references to identified articles and paragraphs, and the titles of other documents or forms.
1. *Addenda*—Written or graphic instruments issued prior to the opening of Bids which clarify, correct, or change the Bidding Requirements or the proposed Contract Documents.
  2. *Agreement*—The written instrument, executed by Owner and Contractor, that sets forth the Contract Price and Contract Times, identifies the parties and the Engineer, and designates the specific items that are Contract Documents.
  3. *Application for Payment*—The document prepared by Contractor, in a form acceptable to Engineer, to request progress or final payments, and which is to be accompanied by such supporting documentation as is required by the Contract Documents.
  4. *Bid*—The offer of a Bidder submitted on the prescribed form setting forth the prices for the Work to be performed.
  5. *Bidder*—An individual or entity that submits a Bid to Owner.
  6. *Bidding Documents*—The Bidding Requirements, the proposed Contract Documents, and all Addenda.
  7. *Bidding Requirements*—The Advertisement or invitation to bid, Instructions to Bidders, Bid Bond or other Bid security, if any, the Bid Form, and the Bid with any attachments.
  8. *Change Order*—A document which is signed by Contractor and Owner and authorizes an addition, deletion, or revision in the Work or an adjustment in the Contract Price or the Contract Times, or other revision to the Contract, issued on or after the Effective Date of the Contract.
  9. *Change Proposal*—A written request by Contractor, duly submitted in compliance with the procedural requirements set forth herein, seeking an adjustment in Contract Price or Contract Times; contesting an initial decision by Engineer concerning the requirements of the Contract Documents or the acceptability of Work under the Contract Documents; challenging a set-off against payments due; or seeking other relief with respect to the terms of the Contract.
  10. *Claim*
    - a. A demand or assertion by Owner directly to Contractor, duly submitted in compliance with the procedural requirements set forth herein, seeking an adjustment of Contract Price or Contract Times; contesting an initial decision by Engineer concerning the

- requirements of the Contract Documents or the acceptability of Work under the Contract Documents; contesting Engineer's decision regarding a Change Proposal; seeking resolution of a contractual issue that Engineer has declined to address; or seeking other relief with respect to the terms of the Contract.
- b. A demand or assertion by Contractor directly to Owner, duly submitted in compliance with the procedural requirements set forth herein, contesting Engineer's decision regarding a Change Proposal, or seeking resolution of a contractual issue that Engineer has declined to address.
  - c. A demand or assertion by Owner or Contractor, duly submitted in compliance with the procedural requirements set forth herein, made pursuant to Paragraph 12.01.A.4, concerning disputes arising after Engineer has issued a recommendation of final payment.
  - d. A demand for money or services by a third party is not a Claim.
11. *Constituent of Concern*—Asbestos, petroleum, radioactive materials, polychlorinated biphenyls (PCBs), lead-based paint (as defined by the HUD/EPA standard), hazardous waste, and any substance, product, waste, or other material of any nature whatsoever that is or becomes listed, regulated, or addressed pursuant to Laws and Regulations regulating, relating to, or imposing liability or standards of conduct concerning, any hazardous, toxic, or dangerous waste, substance, or material.
12. *Contract*—The entire and integrated written contract between Owner and Contractor concerning the Work.
13. *Contract Documents*—Those items so designated in the Agreement, and which together comprise the Contract.
14. *Contract Price*—The money that Owner has agreed to pay Contractor for completion of the Work in accordance with the Contract Documents.
15. *Contract Times*—The number of days or the dates by which Contractor shall: (a) achieve Milestones, if any; (b) achieve Substantial Completion; and (c) complete the Work.
16. *Contractor*—The individual or entity with which Owner has contracted for performance of the Work.
17. *Cost of the Work*—See Paragraph 13.01 for definition.
18. *Drawings*—The part of the Contract that graphically shows the scope, extent, and character of the Work to be performed by Contractor.
19. *Effective Date of the Contract*—The date, indicated in the Agreement, on which the Contract becomes effective.
20. *Electronic Document*—Any Project-related correspondence, attachments to correspondence, data, documents, drawings, information, or graphics, including but not limited to Shop Drawings and other Submittals, that are in an electronic or digital format.
21. *Electronic Means*—Electronic mail (email), upload/download from a secure Project website, or other communications methods that allow: (a) the transmission or communication of Electronic Documents; (b) the documentation of transmissions, including sending and receipt; (c) printing of the transmitted Electronic Document by the

recipient; (d) the storage and archiving of the Electronic Document by sender and recipient; and (e) the use by recipient of the Electronic Document for purposes permitted by this Contract. Electronic Means does not include the use of text messaging, or of Facebook, Twitter, Instagram, or similar social media services for transmission of Electronic Documents.

22. *Engineer*—The individual or entity named as such in the Agreement.
23. *Field Order*—A written order issued by Engineer which requires minor changes in the Work but does not change the Contract Price or the Contract Times.
24. *Hazardous Environmental Condition*—The presence at the Site of Constituents of Concern in such quantities or circumstances that may present a danger to persons or property exposed thereto.
  - a. The presence at the Site of materials that are necessary for the execution of the Work, or that are to be incorporated into the Work, and that are controlled and contained pursuant to industry practices, Laws and Regulations, and the requirements of the Contract, is not a Hazardous Environmental Condition.
  - b. The presence of Constituents of Concern that are to be removed or remediated as part of the Work is not a Hazardous Environmental Condition.
  - c. The presence of Constituents of Concern as part of the routine, anticipated, and obvious working conditions at the Site, is not a Hazardous Environmental Condition.
25. *Laws and Regulations; Laws or Regulations*—Any and all applicable laws, statutes, rules, regulations, ordinances, codes, and binding decrees, resolutions, and orders of any and all governmental bodies, agencies, authorities, and courts having jurisdiction.
26. *Liens*—Charges, security interests, or encumbrances upon Contract-related funds, real property, or personal property.
27. *Milestone*—A principal event in the performance of the Work that the Contract requires Contractor to achieve by an intermediate completion date, or by a time prior to Substantial Completion of all the Work.
28. *Notice of Award*—The written notice by Owner to a Bidder of Owner's acceptance of the Bid.
29. *Notice to Proceed*—A written notice by Owner to Contractor fixing the date on which the Contract Times will commence to run and on which Contractor shall start to perform the Work.
30. *Owner*—The individual or entity with which Contractor has contracted regarding the Work, and which has agreed to pay Contractor for the performance of the Work, pursuant to the terms of the Contract.
31. *Progress Schedule*—A schedule, prepared and maintained by Contractor, describing the sequence and duration of the activities comprising Contractor's plan to accomplish the Work within the Contract Times.
32. *Project*—The total undertaking to be accomplished for Owner by engineers, contractors, and others, including planning, study, design, construction, testing, commissioning, and start-up, and of which the Work to be performed under the Contract Documents is a part.

33. *Resident Project Representative*—The authorized representative of Engineer assigned to assist Engineer at the Site. As used herein, the term Resident Project Representative (RPR) includes any assistants or field staff of Resident Project Representative.
34. *Samples*—Physical examples of materials, equipment, or workmanship that are representative of some portion of the Work and that establish the standards by which such portion of the Work will be judged.
35. *Schedule of Submittals*—A schedule, prepared and maintained by Contractor, of required submittals and the time requirements for Engineer’s review of the submittals.
36. *Schedule of Values*—A schedule, prepared and maintained by Contractor, allocating portions of the Contract Price to various portions of the Work and used as the basis for reviewing Contractor’s Applications for Payment.
37. *Shop Drawings*—All drawings, diagrams, illustrations, schedules, and other data or information that are specifically prepared or assembled by or for Contractor and submitted by Contractor to illustrate some portion of the Work. Shop Drawings, whether approved or not, are not Drawings and are not Contract Documents.
38. *Site*—Lands or areas indicated in the Contract Documents as being furnished by Owner upon which the Work is to be performed, including rights-of-way and easements, and such other lands or areas furnished by Owner which are designated for the use of Contractor.
39. *Specifications*—The part of the Contract that consists of written requirements for materials, equipment, systems, standards, and workmanship as applied to the Work, and certain administrative requirements and procedural matters applicable to the Work.
40. *Subcontractor*—An individual or entity having a direct contract with Contractor or with any other Subcontractor for the performance of a part of the Work.
41. *Submittal*—A written or graphic document, prepared by or for Contractor, which the Contract Documents require Contractor to submit to Engineer, or that is indicated as a Submittal in the Schedule of Submittals accepted by Engineer. Submittals may include Shop Drawings and Samples; schedules; product data; Owner-delegated designs; sustainable design information; information on special procedures; testing plans; results of tests and evaluations, source quality-control testing and inspections, and field or Site quality-control testing and inspections; warranties and certifications; Suppliers’ instructions and reports; records of delivery of spare parts and tools; operations and maintenance data; Project photographic documentation; record documents; and other such documents required by the Contract Documents. Submittals, whether or not approved or accepted by Engineer, are not Contract Documents. Change Proposals, Change Orders, Claims, notices, Applications for Payment, and requests for interpretation or clarification are not Submittals.
42. *Substantial Completion*—The time at which the Work (or a specified part thereof) has progressed to the point where, in the opinion of Engineer, the Work (or a specified part thereof) is sufficiently complete, in accordance with the Contract Documents, so that the Work (or a specified part thereof) can be utilized for the purposes for which it is intended. The terms “substantially complete” and “substantially completed” as applied to all or part of the Work refer to Substantial Completion of such Work.

43. *Successful Bidder*—The Bidder to which the Owner makes an award of contract.
44. *Supplementary Conditions*—The part of the Contract that amends or supplements these General Conditions.
45. *Supplier*—A manufacturer, fabricator, supplier, distributor, or vendor having a direct contract with Contractor or with any Subcontractor to furnish materials or equipment to be incorporated in the Work by Contractor or a Subcontractor.
46. *Technical Data*
- a. Those items expressly identified as Technical Data in the Supplementary Conditions, with respect to either (1) existing subsurface conditions at or adjacent to the Site, or existing physical conditions at or adjacent to the Site including existing surface or subsurface structures (except Underground Facilities) or (2) Hazardous Environmental Conditions at the Site.
  - b. If no such express identifications of Technical Data have been made with respect to conditions at the Site, then Technical Data is defined, with respect to conditions at the Site under Paragraphs 5.03, 5.04, and 5.06, as the data contained in boring logs, recorded measurements of subsurface water levels, assessments of the condition of subsurface facilities, laboratory test results, and other factual, objective information regarding conditions at the Site that are set forth in any geotechnical, environmental, or other Site or facilities conditions report prepared for the Project and made available to Contractor.
  - c. Information and data regarding the presence or location of Underground Facilities are not intended to be categorized, identified, or defined as Technical Data, and instead Underground Facilities are shown or indicated on the Drawings.
47. *Underground Facilities*—All active or not-in-service underground lines, pipelines, conduits, ducts, encasements, cables, wires, manholes, vaults, tanks, tunnels, or other such facilities or systems at the Site, including but not limited to those facilities or systems that produce, transmit, distribute, or convey telephone or other communications, cable television, fiber optic transmissions, power, electricity, light, heat, gases, oil, crude oil products, liquid petroleum products, water, steam, waste, wastewater, storm water, other liquids or chemicals, or traffic or other control systems. An abandoned facility or system is not an Underground Facility.
48. *Unit Price Work*—Work to be paid for on the basis of unit prices.
49. *Work*—The entire construction or the various separately identifiable parts thereof required to be provided under the Contract Documents. Work includes and is the result of performing or providing all labor, services, and documentation necessary to produce such construction; furnishing, installing, and incorporating all materials and equipment into such construction; and may include related services such as testing, start-up, and commissioning, all as required by the Contract Documents.
50. *Work Change Directive*—A written directive to Contractor issued on or after the Effective Date of the Contract, signed by Owner and recommended by Engineer, ordering an addition, deletion, or revision in the Work.

## 1.02 Terminology

- A. The words and terms discussed in Paragraphs 1.02.B, C, D, and E are not defined terms that require initial capital letters, but, when used in the Bidding Requirements or Contract Documents, have the indicated meaning.
- B. *Intent of Certain Terms or Adjectives:* The Contract Documents include the terms “as allowed,” “as approved,” “as ordered,” “as directed” or terms of like effect or import to authorize an exercise of professional judgment by Engineer. In addition, the adjectives “reasonable,” “suitable,” “acceptable,” “proper,” “satisfactory,” or adjectives of like effect or import are used to describe an action or determination of Engineer as to the Work. It is intended that such exercise of professional judgment, action, or determination will be solely to evaluate, in general, the Work for compliance with the information in the Contract Documents and with the design concept of the Project as a functioning whole as shown or indicated in the Contract Documents (unless there is a specific statement indicating otherwise). The use of any such term or adjective is not intended to and shall not be effective to assign to Engineer any duty or authority to supervise or direct the performance of the Work, or any duty or authority to undertake responsibility contrary to the provisions of Article 10 or any other provision of the Contract Documents.
- C. *Day:* The word “day” means a calendar day of 24 hours measured from midnight to the next midnight.
- D. *Defective:* The word “defective,” when modifying the word “Work,” refers to Work that is unsatisfactory, faulty, or deficient in that it:
  - 1. does not conform to the Contract Documents;
  - 2. does not meet the requirements of any applicable inspection, reference standard, test, or approval referred to in the Contract Documents; or
  - 3. has been damaged prior to Engineer’s recommendation of final payment (unless responsibility for the protection thereof has been assumed by Owner at Substantial Completion in accordance with Paragraph 15.03 or Paragraph 15.04).
- E. *Furnish, Install, Perform, Provide*
  - 1. The word “furnish,” when used in connection with services, materials, or equipment, means to supply and deliver said services, materials, or equipment to the Site (or some other specified location) ready for use or installation and in usable or operable condition.
  - 2. The word “install,” when used in connection with services, materials, or equipment, means to put into use or place in final position said services, materials, or equipment complete and ready for intended use.
  - 3. The words “perform” or “provide,” when used in connection with services, materials, or equipment, means to furnish and install said services, materials, or equipment complete and ready for intended use.
  - 4. If the Contract Documents establish an obligation of Contractor with respect to specific services, materials, or equipment, but do not expressly use any of the four words “furnish,” “install,” “perform,” or “provide,” then Contractor shall furnish and install said services, materials, or equipment complete and ready for intended use.



- F. *Contract Price or Contract Times*: References to a change in “Contract Price or Contract Times” or “Contract Times or Contract Price” or similar, indicate that such change applies to (1) Contract Price, (2) Contract Times, or (3) both Contract Price and Contract Times, as warranted, even if the term “or both” is not expressed.
- G. Unless stated otherwise in the Contract Documents, words or phrases that have a well-known technical or construction industry or trade meaning are used in the Contract Documents in accordance with such recognized meaning.

## **ARTICLE 2—PRELIMINARY MATTERS**

### **2.01 *Delivery of Performance and Payment Bonds; Evidence of Insurance***

- A. *Performance and Payment Bonds*: When Contractor delivers the signed counterparts of the Agreement to Owner, Contractor shall also deliver to Owner the performance bond and payment bond (if the Contract requires Contractor to furnish such bonds).
- B. *Evidence of Contractor’s Insurance*: When Contractor delivers the signed counterparts of the Agreement to Owner, Contractor shall also deliver to Owner, with copies to each additional insured (as identified in the Contract), the certificates, endorsements, and other evidence of insurance required to be provided by Contractor in accordance with Article 6, except to the extent the Supplementary Conditions expressly establish other dates for delivery of specific insurance policies.
- C. *Evidence of Owner’s Insurance*: After receipt of the signed counterparts of the Agreement and all required bonds and insurance documentation, Owner shall promptly deliver to Contractor, with copies to each additional insured (as identified in the Contract), the certificates and other evidence of insurance required to be provided by Owner under Article 6.

### **2.02 *Copies of Documents***

- A. Owner shall furnish to Contractor four printed copies of the Contract (including one fully signed counterpart of the Agreement), and one copy in electronic portable document format (PDF). Additional printed copies will be furnished upon request at the cost of reproduction.
- B. Owner shall maintain and safeguard at least one original printed record version of the Contract, including Drawings and Specifications signed and sealed by Engineer and other design professionals. Owner shall make such original printed record version of the Contract available to Contractor for review. Owner may delegate the responsibilities under this provision to Engineer.

### **2.03 *Before Starting Construction***

- A. *Preliminary Schedules*: Within 10 days after the Effective Date of the Contract (or as otherwise required by the Contract Documents), Contractor shall submit to Engineer for timely review:
  - 1. a preliminary Progress Schedule indicating the times (numbers of days or dates) for starting and completing the various stages of the Work, including any Milestones specified in the Contract;
  - 2. a preliminary Schedule of Submittals; and
  - 3. a preliminary Schedule of Values for all of the Work which includes quantities and prices of items which when added together equal the Contract Price and subdivides the Work

into component parts in sufficient detail to serve as the basis for progress payments during performance of the Work. Such prices will include an appropriate amount of overhead and profit applicable to each item of Work.

2.04 *Preconstruction Conference; Designation of Authorized Representatives*

- A. Before any Work at the Site is started, a conference attended by Owner, Contractor, Engineer, and others as appropriate will be held to establish a working understanding among the parties as to the Work, and to discuss the schedules referred to in Paragraph 2.03.A, procedures for handling Shop Drawings, Samples, and other Submittals, processing Applications for Payment, electronic or digital transmittals, and maintaining required records.
- B. At this conference Owner and Contractor each shall designate, in writing, a specific individual to act as its authorized representative with respect to the services and responsibilities under the Contract. Such individuals shall have the authority to transmit and receive information, render decisions relative to the Contract, and otherwise act on behalf of each respective party.

2.05 *Acceptance of Schedules*

- A. At least 10 days before submission of the first Application for Payment a conference, attended by Contractor, Engineer, and others as appropriate, will be held to review the schedules submitted in accordance with Paragraph 2.03.A. No progress payment will be made to Contractor until acceptable schedules are submitted to Engineer.
  - 1. The Progress Schedule will be acceptable to Engineer if it provides an orderly progression of the Work to completion within the Contract Times. Such acceptance will not impose on Engineer responsibility for the Progress Schedule, for sequencing, scheduling, or progress of the Work, nor interfere with or relieve Contractor from Contractor's full responsibility therefor.
  - 2. Contractor's Schedule of Submittals will be acceptable to Engineer if it provides a workable arrangement for reviewing and processing the required submittals.
  - 3. Contractor's Schedule of Values will be acceptable to Engineer as to form and substance if it provides a reasonable allocation of the Contract Price to the component parts of the Work.
  - 4. If a schedule is not acceptable, Contractor will have an additional 10 days to revise and resubmit the schedule.

2.06 *Electronic Transmittals*

- A. Except as otherwise stated elsewhere in the Contract, the Owner, Engineer, and Contractor may send, and shall accept, Electronic Documents transmitted by Electronic Means.
- B. If the Contract does not establish protocols for Electronic Means, then Owner, Engineer, and Contractor shall jointly develop such protocols.
- C. Subject to any governing protocols for Electronic Means, when transmitting Electronic Documents by Electronic Means, the transmitting party makes no representations as to long-term compatibility, usability, or readability of the Electronic Documents resulting from the recipient's use of software application packages, operating systems, or computer hardware differing from those used in the drafting or transmittal of the Electronic Documents.

## ARTICLE 3—CONTRACT DOCUMENTS: INTENT, REQUIREMENTS, REUSE

### 3.01 *Intent*

- A. The Contract Documents are complementary; what is required by one Contract Document is as binding as if required by all.
- B. It is the intent of the Contract Documents to describe a functionally complete Project (or part thereof) to be constructed in accordance with the Contract Documents.
- C. Unless otherwise stated in the Contract Documents, if there is a discrepancy between the electronic versions of the Contract Documents (including any printed copies derived from such electronic versions) and the printed record version, the printed record version will govern.
- D. The Contract supersedes prior negotiations, representations, and agreements, whether written or oral.
- E. Engineer will issue clarifications and interpretations of the Contract Documents as provided herein.
- F. Any provision or part of the Contract Documents held to be void or unenforceable under any Law or Regulation will be deemed stricken, and all remaining provisions will continue to be valid and binding upon Owner and Contractor, which agree that the Contract Documents will be reformed to replace such stricken provision or part thereof with a valid and enforceable provision that comes as close as possible to expressing the intention of the stricken provision.
- G. Nothing in the Contract Documents creates:
  - 1. any contractual relationship between Owner or Engineer and any Subcontractor, Supplier, or other individual or entity performing or furnishing any of the Work, for the benefit of such Subcontractor, Supplier, or other individual or entity; or
  - 2. any obligation on the part of Owner or Engineer to pay or to see to the payment of any money due any such Subcontractor, Supplier, or other individual or entity, except as may otherwise be required by Laws and Regulations.

### 3.02 *Reference Standards*

- A. *Standards Specifications, Codes, Laws and Regulations*
  - 1. Reference in the Contract Documents to standard specifications, manuals, reference standards, or codes of any technical society, organization, or association, or to Laws or Regulations, whether such reference be specific or by implication, means the standard specification, manual, reference standard, code, or Laws or Regulations in effect at the time of opening of Bids (or on the Effective Date of the Contract if there were no Bids), except as may be otherwise specifically stated in the Contract Documents.
  - 2. No provision of any such standard specification, manual, reference standard, or code, and no instruction of a Supplier, will be effective to change the duties or responsibilities of Owner, Contractor, or Engineer from those set forth in the part of the Contract Documents prepared by or for Engineer. No such provision or instruction shall be effective to assign to Owner or Engineer any duty or authority to supervise or direct the performance of the Work, or any duty or authority to undertake responsibility

inconsistent with the provisions of the part of the Contract Documents prepared by or for Engineer.

### 3.03 *Reporting and Resolving Discrepancies*

#### A. *Reporting Discrepancies*

1. *Contractor's Verification of Figures and Field Measurements:* Before undertaking each part of the Work, Contractor shall carefully study the Contract Documents, and check and verify pertinent figures and dimensions therein, particularly with respect to applicable field measurements. Contractor shall promptly report in writing to Engineer any conflict, error, ambiguity, or discrepancy that Contractor discovers, or has actual knowledge of, and shall not proceed with any Work affected thereby until the conflict, error, ambiguity, or discrepancy is resolved by a clarification or interpretation by Engineer, or by an amendment or supplement to the Contract issued pursuant to Paragraph 11.01.
2. *Contractor's Review of Contract Documents:* If, before or during the performance of the Work, Contractor discovers any conflict, error, ambiguity, or discrepancy within the Contract Documents, or between the Contract Documents and (a) any applicable Law or Regulation, (b) actual field conditions, (c) any standard specification, manual, reference standard, or code, or (d) any instruction of any Supplier, then Contractor shall promptly report it to Engineer in writing. Contractor shall not proceed with the Work affected thereby (except in an emergency as required by Paragraph 7.15) until the conflict, error, ambiguity, or discrepancy is resolved, by a clarification or interpretation by Engineer, or by an amendment or supplement to the Contract issued pursuant to Paragraph 11.01.
3. Contractor shall not be liable to Owner or Engineer for failure to report any conflict, error, ambiguity, or discrepancy in the Contract Documents unless Contractor had actual knowledge thereof.

#### B. *Resolving Discrepancies*

1. Except as may be otherwise specifically stated in the Contract Documents, the provisions of the part of the Contract Documents prepared by or for Engineer take precedence in resolving any conflict, error, ambiguity, or discrepancy between such provisions of the Contract Documents and:
  - a. the provisions of any standard specification, manual, reference standard, or code, or the instruction of any Supplier (whether or not specifically incorporated by reference as a Contract Document); or
  - b. the provisions of any Laws or Regulations applicable to the performance of the Work (unless such an interpretation of the provisions of the Contract Documents would result in violation of such Law or Regulation).

### 3.04 *Requirements of the Contract Documents*

- A. During the performance of the Work and until final payment, Contractor and Owner shall submit to the Engineer in writing all matters in question concerning the requirements of the Contract Documents (sometimes referred to as requests for information or interpretation—RFIs), or relating to the acceptability of the Work under the Contract Documents, as soon as possible after such matters arise. Engineer will be the initial interpreter of the requirements of the Contract Documents, and judge of the acceptability of the Work.

- B. Engineer will, with reasonable promptness, render a written clarification, interpretation, or decision on the issue submitted, or initiate an amendment or supplement to the Contract Documents. Engineer's written clarification, interpretation, or decision will be final and binding on Contractor, unless it appeals by submitting a Change Proposal, and on Owner, unless it appeals by filing a Claim.
- C. If a submitted matter in question concerns terms and conditions of the Contract Documents that do not involve (1) the performance or acceptability of the Work under the Contract Documents, (2) the design (as set forth in the Drawings, Specifications, or otherwise), or (3) other engineering or technical matters, then Engineer will promptly notify Owner and Contractor in writing that Engineer is unable to provide a decision or interpretation. If Owner and Contractor are unable to agree on resolution of such a matter in question, either party may pursue resolution as provided in Article 12.

### 3.05 *Reuse of Documents*

- A. Contractor and its Subcontractors and Suppliers shall not:
  - 1. have or acquire any title to or ownership rights in any of the Drawings, Specifications, or other documents (or copies of any thereof) prepared by or bearing the seal of Engineer or its consultants, including electronic media versions, or reuse any such Drawings, Specifications, other documents, or copies thereof on extensions of the Project or any other project without written consent of Owner and Engineer and specific written verification or adaptation by Engineer; or
  - 2. have or acquire any title or ownership rights in any other Contract Documents, reuse any such Contract Documents for any purpose without Owner's express written consent, or violate any copyrights pertaining to such Contract Documents.
- B. The prohibitions of this Paragraph 3.05 will survive final payment, or termination of the Contract. Nothing herein precludes Contractor from retaining copies of the Contract Documents for record purposes.

## **ARTICLE 4—COMMENCEMENT AND PROGRESS OF THE WORK**

### 4.01 *Commencement of Contract Times; Notice to Proceed*

- A. The Contract Times will commence to run on the 30th day after the Effective Date of the Contract or, if a Notice to Proceed is given, on the day indicated in the Notice to Proceed. A Notice to Proceed may be given at any time within 30 days after the Effective Date of the Contract. In no event will the Contract Times commence to run later than the 60th day after the day of Bid opening or the 30th day after the Effective Date of the Contract, whichever date is earlier.

### 4.02 *Starting the Work*

- A. Contractor shall start to perform the Work on the date when the Contract Times commence to run. No Work may be done at the Site prior to such date.

### 4.03 *Reference Points*

- A. Owner shall provide engineering surveys to establish reference points for construction which in Engineer's judgment are necessary to enable Contractor to proceed with the Work. Contractor shall be responsible for laying out the Work, shall protect and preserve the

established reference points and property monuments, and shall make no changes or relocations without the prior written approval of Owner. Contractor shall report to Engineer whenever any reference point or property monument is lost or destroyed or requires relocation because of necessary changes in grades or locations, and shall be responsible for the accurate replacement or relocation of such reference points or property monuments by professionally qualified personnel.

#### 4.04 *Progress Schedule*

- A. Contractor shall adhere to the Progress Schedule established in accordance with Paragraph 2.05 as it may be adjusted from time to time as provided below.
  - 1. Contractor shall submit to Engineer for acceptance (to the extent indicated in Paragraph 2.05) proposed adjustments in the Progress Schedule that will not result in changing the Contract Times.
  - 2. Proposed adjustments in the Progress Schedule that will change the Contract Times must be submitted in accordance with the requirements of Article 11.
- B. Contractor shall carry on the Work and adhere to the Progress Schedule during all disputes or disagreements with Owner. No Work will be delayed or postponed pending resolution of any disputes or disagreements, or during any appeal process, except as permitted by Paragraph 16.04, or as Owner and Contractor may otherwise agree in writing.

#### 4.05 *Delays in Contractor's Progress*

- A. If Owner, Engineer, or anyone for whom Owner is responsible, delays, disrupts, or interferes with the performance or progress of the Work, then Contractor shall be entitled to an equitable adjustment in Contract Price or Contract Times.
- B. Contractor shall not be entitled to an adjustment in Contract Price or Contract Times for delay, disruption, or interference caused by or within the control of Contractor. Delay, disruption, and interference attributable to and within the control of a Subcontractor or Supplier shall be deemed to be within the control of Contractor.
- C. If Contractor's performance or progress is delayed, disrupted, or interfered with by unanticipated causes not the fault of and beyond the control of Owner, Contractor, and those for which they are responsible, then Contractor shall be entitled to an equitable adjustment in Contract Times. Such an adjustment will be Contractor's sole and exclusive remedy for the delays, disruption, and interference described in this paragraph. Causes of delay, disruption, or interference that may give rise to an adjustment in Contract Times under this paragraph include but are not limited to the following:
  - 1. Severe and unavoidable natural catastrophes such as fires, floods, epidemics, and earthquakes;
  - 2. Abnormal weather conditions;
  - 3. Acts or failures to act of third-party utility owners or other third-party entities (other than those third-party utility owners or other third-party entities performing other work at or adjacent to the Site as arranged by or under contract with Owner, as contemplated in Article 8); and
  - 4. Acts of war or terrorism.

- D. Contractor's entitlement to an adjustment of Contract Times or Contract Price is limited as follows:
1. Contractor's entitlement to an adjustment of the Contract Times is conditioned on the delay, disruption, or interference adversely affecting an activity on the critical path to completion of the Work, as of the time of the delay, disruption, or interference.
  2. Contractor shall not be entitled to an adjustment in Contract Price for any delay, disruption, or interference if such delay is concurrent with a delay, disruption, or interference caused by or within the control of Contractor. Such a concurrent delay by Contractor shall not preclude an adjustment of Contract Times to which Contractor is otherwise entitled.
  3. Adjustments of Contract Times or Contract Price are subject to the provisions of Article 11.
- E. Each Contractor request or Change Proposal seeking an increase in Contract Times or Contract Price must be supplemented by supporting data that sets forth in detail the following:
1. The circumstances that form the basis for the requested adjustment;
  2. The date upon which each cause of delay, disruption, or interference began to affect the progress of the Work;
  3. The date upon which each cause of delay, disruption, or interference ceased to affect the progress of the Work;
  4. The number of days' increase in Contract Times claimed as a consequence of each such cause of delay, disruption, or interference; and
  5. The impact on Contract Price, in accordance with the provisions of Paragraph 11.07.
- Contractor shall also furnish such additional supporting documentation as Owner or Engineer may require including, where appropriate, a revised progress schedule indicating all the activities affected by the delay, disruption, or interference, and an explanation of the effect of the delay, disruption, or interference on the critical path to completion of the Work.
- F. Delays, disruption, and interference to the performance or progress of the Work resulting from the existence of a differing subsurface or physical condition, an Underground Facility that was not shown or indicated by the Contract Documents, or not shown or indicated with reasonable accuracy, and those resulting from Hazardous Environmental Conditions, are governed by Article 5, together with the provisions of Paragraphs 4.05.D and 4.05.E.
- G. Paragraph 8.03 addresses delays, disruption, and interference to the performance or progress of the Work resulting from the performance of certain other work at or adjacent to the Site.

## **ARTICLE 5—SITE; SUBSURFACE AND PHYSICAL CONDITIONS; HAZARDOUS ENVIRONMENTAL CONDITIONS**

### **5.01 *Availability of Lands***

- A. Owner shall furnish the Site. Owner shall notify Contractor in writing of any encumbrances or restrictions not of general application but specifically related to use of the Site with which Contractor must comply in performing the Work.

- B. Upon reasonable written request, Owner shall furnish Contractor with a current statement of record legal title and legal description of the lands upon which permanent improvements are to be made and Owner's interest therein as necessary for giving notice of or filing a mechanic's or construction lien against such lands in accordance with applicable Laws and Regulations.
- C. Contractor shall provide for all additional lands and access thereto that may be required for temporary construction facilities or storage of materials and equipment.

## 5.02 *Use of Site and Other Areas*

### A. *Limitation on Use of Site and Other Areas*

1. Contractor shall confine construction equipment, temporary construction facilities, the storage of materials and equipment, and the operations of workers to the Site, adjacent areas that Contractor has arranged to use through construction easements or otherwise, and other adjacent areas permitted by Laws and Regulations, and shall not unreasonably encumber the Site and such other adjacent areas with construction equipment or other materials or equipment. Contractor shall assume full responsibility for (a) damage to the Site; (b) damage to any such other adjacent areas used for Contractor's operations; (c) damage to any other adjacent land or areas, or to improvements, structures, utilities, or similar facilities located at such adjacent lands or areas; and (d) for injuries and losses sustained by the owners or occupants of any such land or areas; provided that such damage or injuries result from the performance of the Work or from other actions or conduct of the Contractor or those for which Contractor is responsible.
  2. If a damage or injury claim is made by the owner or occupant of any such land or area because of the performance of the Work, or because of other actions or conduct of the Contractor or those for which Contractor is responsible, Contractor shall (a) take immediate corrective or remedial action as required by Paragraph 7.13, or otherwise; (b) promptly attempt to settle the claim as to all parties through negotiations with such owner or occupant, or otherwise resolve the claim by arbitration or other dispute resolution proceeding, or in a court of competent jurisdiction; and (c) to the fullest extent permitted by Laws and Regulations, indemnify and hold harmless Owner and Engineer, and the officers, directors, members, partners, employees, agents, consultants and subcontractors of each and any of them, from and against any such claim, and against all costs, losses, and damages (including but not limited to all fees and charges of engineers, architects, attorneys, and other professionals and all court or arbitration or other dispute resolution costs) arising out of or relating to any claim or action, legal or equitable, brought by any such owner or occupant against Owner, Engineer, or any other party indemnified hereunder to the extent caused directly or indirectly, in whole or in part by, or based upon, Contractor's performance of the Work, or because of other actions or conduct of the Contractor or those for which Contractor is responsible.
- B. *Removal of Debris During Performance of the Work:* During the progress of the Work the Contractor shall keep the Site and other adjacent areas free from accumulations of waste materials, rubbish, and other debris. Removal and disposal of such waste materials, rubbish, and other debris will conform to applicable Laws and Regulations.
  - C. *Cleaning:* Prior to Substantial Completion of the Work Contractor shall clean the Site and the Work and make it ready for utilization by Owner. At the completion of the Work Contractor shall remove from the Site and adjacent areas all tools, appliances, construction equipment



and machinery, and surplus materials and shall restore to original condition all property not designated for alteration by the Contract Documents.

- D. *Loading of Structures:* Contractor shall not load nor permit any part of any structure to be loaded in any manner that will endanger the structure, nor shall Contractor subject any part of the Work or adjacent structures or land to stresses or pressures that will endanger them.

### 5.03 *Subsurface and Physical Conditions*

- A. *Reports and Drawings:* The Supplementary Conditions identify:

1. Those reports of explorations and tests of subsurface conditions at or adjacent to the Site that contain Technical Data;
2. Those drawings of existing physical conditions at or adjacent to the Site, including those drawings depicting existing surface or subsurface structures at or adjacent to the Site (except Underground Facilities), that contain Technical Data; and
3. Technical Data contained in such reports and drawings.

- B. *Underground Facilities:* Underground Facilities are shown or indicated on the Drawings, pursuant to Paragraph 5.05, and not in the drawings referred to in Paragraph 5.03.A. Information and data regarding the presence or location of Underground Facilities are not intended to be categorized, identified, or defined as Technical Data.

- C. *Reliance by Contractor on Technical Data:* Contractor may rely upon the accuracy of the Technical Data expressly identified in the Supplementary Conditions with respect to such reports and drawings, but such reports and drawings are not Contract Documents. If no such express identification has been made, then Contractor may rely upon the accuracy of the Technical Data as defined in Paragraph 1.01.A.46.b.

- D. *Limitations of Other Data and Documents:* Except for such reliance on Technical Data, Contractor may not rely upon or make any claim against Owner or Engineer, or any of their officers, directors, members, partners, employees, agents, consultants, or subcontractors, with respect to:

1. the completeness of such reports and drawings for Contractor's purposes, including, but not limited to, any aspects of the means, methods, techniques, sequences, and procedures of construction to be employed by Contractor, and safety precautions and programs incident thereto;
2. other data, interpretations, opinions, and information contained in such reports or shown or indicated in such drawings;
3. the contents of other Site-related documents made available to Contractor, such as record drawings from other projects at or adjacent to the Site, or Owner's archival documents concerning the Site; or
4. any Contractor interpretation of or conclusion drawn from any Technical Data or any such other data, interpretations, opinions, or information.

#### 5.04 *Differing Subsurface or Physical Conditions*

- A. *Notice by Contractor:* If Contractor believes that any subsurface or physical condition that is uncovered or revealed at the Site:
1. is of such a nature as to establish that any Technical Data on which Contractor is entitled to rely as provided in Paragraph 5.03 is materially inaccurate;
  2. is of such a nature as to require a change in the Drawings or Specifications;
  3. differs materially from that shown or indicated in the Contract Documents; or
  4. is of an unusual nature, and differs materially from conditions ordinarily encountered and generally recognized as inherent in work of the character provided for in the Contract Documents;

then Contractor shall, promptly after becoming aware thereof and before further disturbing the subsurface or physical conditions or performing any Work in connection therewith (except in an emergency as required by Paragraph 7.15), notify Owner and Engineer in writing about such condition. Contractor shall not further disturb such condition or perform any Work in connection therewith (except with respect to an emergency) until receipt of a written statement permitting Contractor to do so.

- B. *Engineer's Review:* After receipt of written notice as required by the preceding paragraph, Engineer will promptly review the subsurface or physical condition in question; determine whether it is necessary for Owner to obtain additional exploration or tests with respect to the condition; conclude whether the condition falls within any one or more of the differing site condition categories in Paragraph 5.04.A; obtain any pertinent cost or schedule information from Contractor; prepare recommendations to Owner regarding the Contractor's resumption of Work in connection with the subsurface or physical condition in question and the need for any change in the Drawings or Specifications; and advise Owner in writing of Engineer's findings, conclusions, and recommendations.
- C. *Owner's Statement to Contractor Regarding Site Condition:* After receipt of Engineer's written findings, conclusions, and recommendations, Owner shall issue a written statement to Contractor (with a copy to Engineer) regarding the subsurface or physical condition in question, addressing the resumption of Work in connection with such condition, indicating whether any change in the Drawings or Specifications will be made, and adopting or rejecting Engineer's written findings, conclusions, and recommendations, in whole or in part.
- D. *Early Resumption of Work:* If at any time Engineer determines that Work in connection with the subsurface or physical condition in question may resume prior to completion of Engineer's review or Owner's issuance of its statement to Contractor, because the condition in question has been adequately documented, and analyzed on a preliminary basis, then the Engineer may at its discretion instruct Contractor to resume such Work.
- E. *Possible Price and Times Adjustments*
1. Contractor shall be entitled to an equitable adjustment in Contract Price or Contract Times, to the extent that the existence of a differing subsurface or physical condition, or any related delay, disruption, or interference, causes an increase or decrease in

Contractor's cost of, or time required for, performance of the Work; subject, however, to the following:

- a. Such condition must fall within any one or more of the categories described in Paragraph 5.04.A;
  - b. With respect to Work that is paid for on a unit price basis, any adjustment in Contract Price will be subject to the provisions of Paragraph 13.03; and,
  - c. Contractor's entitlement to an adjustment of the Contract Times is subject to the provisions of Paragraphs 4.05.D and 4.05.E.
2. Contractor shall not be entitled to any adjustment in the Contract Price or Contract Times with respect to a subsurface or physical condition if:
- a. Contractor knew of the existence of such condition at the time Contractor made a commitment to Owner with respect to Contract Price and Contract Times by the submission of a Bid or becoming bound under a negotiated contract, or otherwise;
  - b. The existence of such condition reasonably could have been discovered or revealed as a result of any examination, investigation, exploration, test, or study of the Site and contiguous areas expressly required by the Bidding Requirements or Contract Documents to be conducted by or for Contractor prior to Contractor's making such commitment; or
  - c. Contractor failed to give the written notice required by Paragraph 5.04.A.
3. If Owner and Contractor agree regarding Contractor's entitlement to and the amount or extent of any adjustment in the Contract Price or Contract Times, then any such adjustment will be set forth in a Change Order.
4. Contractor may submit a Change Proposal regarding its entitlement to or the amount or extent of any adjustment in the Contract Price or Contract Times, no later than 30 days after Owner's issuance of the Owner's written statement to Contractor regarding the subsurface or physical condition in question.
- F. *Underground Facilities; Hazardous Environmental Conditions*: Paragraph 5.05 governs rights and responsibilities regarding the presence or location of Underground Facilities. Paragraph 5.06 governs rights and responsibilities regarding Hazardous Environmental Conditions. The provisions of Paragraphs 5.03 and 5.04 are not applicable to the presence or location of Underground Facilities, or to Hazardous Environmental Conditions.

#### 5.05 *Underground Facilities*

- A. *Contractor's Responsibilities*: Unless it is otherwise expressly provided in the Supplementary Conditions, the cost of all of the following are included in the Contract Price, and Contractor shall have full responsibility for:
1. reviewing and checking all information and data regarding existing Underground Facilities at the Site;
  2. complying with applicable state and local utility damage prevention Laws and Regulations;

3. verifying the actual location of those Underground Facilities shown or indicated in the Contract Documents as being within the area affected by the Work, by exposing such Underground Facilities during the course of construction;
  4. coordination of the Work with the owners (including Owner) of such Underground Facilities, during construction; and
  5. the safety and protection of all existing Underground Facilities at the Site, and repairing any damage thereto resulting from the Work.
- B. *Notice by Contractor:* If Contractor believes that an Underground Facility that is uncovered or revealed at the Site was not shown or indicated on the Drawings, or was not shown or indicated on the Drawings with reasonable accuracy, then Contractor shall, promptly after becoming aware thereof and before further disturbing conditions affected thereby or performing any Work in connection therewith (except in an emergency as required by Paragraph 7.15), notify Owner and Engineer in writing regarding such Underground Facility.
- C. *Engineer's Review:* Engineer will:
1. promptly review the Underground Facility and conclude whether such Underground Facility was not shown or indicated on the Drawings, or was not shown or indicated with reasonable accuracy;
  2. identify and communicate with the owner of the Underground Facility; prepare recommendations to Owner (and if necessary issue any preliminary instructions to Contractor) regarding the Contractor's resumption of Work in connection with the Underground Facility in question;
  3. obtain any pertinent cost or schedule information from Contractor; determine the extent, if any, to which a change is required in the Drawings or Specifications to reflect and document the consequences of the existence or location of the Underground Facility; and
  4. advise Owner in writing of Engineer's findings, conclusions, and recommendations.

During such time, Contractor shall be responsible for the safety and protection of such Underground Facility.

- D. *Owner's Statement to Contractor Regarding Underground Facility:* After receipt of Engineer's written findings, conclusions, and recommendations, Owner shall issue a written statement to Contractor (with a copy to Engineer) regarding the Underground Facility in question addressing the resumption of Work in connection with such Underground Facility, indicating whether any change in the Drawings or Specifications will be made, and adopting or rejecting Engineer's written findings, conclusions, and recommendations in whole or in part.
- E. *Early Resumption of Work:* If at any time Engineer determines that Work in connection with the Underground Facility may resume prior to completion of Engineer's review or Owner's issuance of its statement to Contractor, because the Underground Facility in question and conditions affected by its presence have been adequately documented, and analyzed on a preliminary basis, then the Engineer may at its discretion instruct Contractor to resume such Work.
- F. *Possible Price and Times Adjustments*
1. Contractor shall be entitled to an equitable adjustment in the Contract Price or Contract Times, to the extent that any existing Underground Facility at the Site that was not shown

or indicated on the Drawings, or was not shown or indicated with reasonable accuracy, or any related delay, disruption, or interference, causes an increase or decrease in Contractor's cost of, or time required for, performance of the Work; subject, however, to the following:

- a. With respect to Work that is paid for on a unit price basis, any adjustment in Contract Price will be subject to the provisions of Paragraph 13.03;
  - b. Contractor's entitlement to an adjustment of the Contract Times is subject to the provisions of Paragraphs 4.05.D and 4.05.E; and
  - c. Contractor gave the notice required in Paragraph 5.05.B.
2. If Owner and Contractor agree regarding Contractor's entitlement to and the amount or extent of any adjustment in the Contract Price or Contract Times, then any such adjustment will be set forth in a Change Order.
  3. Contractor may submit a Change Proposal regarding its entitlement to or the amount or extent of any adjustment in the Contract Price or Contract Times, no later than 30 days after Owner's issuance of the Owner's written statement to Contractor regarding the Underground Facility in question.
  4. The information and data shown or indicated on the Drawings with respect to existing Underground Facilities at the Site is based on information and data (a) furnished by the owners of such Underground Facilities, or by others, (b) obtained from available records, or (c) gathered in an investigation conducted in accordance with the current edition of ASCE 38, Standard Guideline for the Collection and Depiction of Existing Subsurface Utility Data, by the American Society of Civil Engineers. If such information or data is incorrect or incomplete, Contractor's remedies are limited to those set forth in this Paragraph 5.05.F.

#### 5.06 *Hazardous Environmental Conditions at Site*

A. *Reports and Drawings:* The Supplementary Conditions identify:

1. those reports known to Owner relating to Hazardous Environmental Conditions that have been identified at or adjacent to the Site;
2. drawings known to Owner relating to Hazardous Environmental Conditions that have been identified at or adjacent to the Site; and
3. Technical Data contained in such reports and drawings.

B. *Reliance by Contractor on Technical Data Authorized:* Contractor may rely upon the accuracy of the Technical Data expressly identified in the Supplementary Conditions with respect to such reports and drawings, but such reports and drawings are not Contract Documents. If no such express identification has been made, then Contractor may rely on the accuracy of the Technical Data as defined in Paragraph 1.01.A.46.b. Except for such reliance on Technical Data, Contractor may not rely upon or make any claim against Owner or Engineer, or any of their officers, directors, members, partners, employees, agents, consultants, or subcontractors, with respect to:

1. the completeness of such reports and drawings for Contractor's purposes, including, but not limited to, any aspects of the means, methods, techniques, sequences and procedures

- of construction to be employed by Contractor, and safety precautions and programs incident thereto;
2. other data, interpretations, opinions, and information contained in such reports or shown or indicated in such drawings; or
  3. any Contractor interpretation of or conclusion drawn from any Technical Data or any such other data, interpretations, opinions or information.
- C. Contractor shall not be responsible for removing or remediating any Hazardous Environmental Condition encountered, uncovered, or revealed at the Site unless such removal or remediation is expressly identified in the Contract Documents to be within the scope of the Work.
- D. Contractor shall be responsible for controlling, containing, and duly removing all Constituents of Concern brought to the Site by Contractor, Subcontractors, Suppliers, or anyone else for whom Contractor is responsible, and for any associated costs; and for the costs of removing and remediating any Hazardous Environmental Condition created by the presence of any such Constituents of Concern.
- E. If Contractor encounters, uncovers, or reveals a Hazardous Environmental Condition whose removal or remediation is not expressly identified in the Contract Documents as being within the scope of the Work, or if Contractor or anyone for whom Contractor is responsible creates a Hazardous Environmental Condition, then Contractor shall immediately: (1) secure or otherwise isolate such condition; (2) stop all Work in connection with such condition and in any area affected thereby (except in an emergency as required by Paragraph 7.15); and (3) notify Owner and Engineer (and promptly thereafter confirm such notice in writing). Owner shall promptly consult with Engineer concerning the necessity for Owner to retain a qualified expert to evaluate such condition or take corrective action, if any. Promptly after consulting with Engineer, Owner shall take such actions as are necessary to permit Owner to timely obtain required permits and provide Contractor the written notice required by Paragraph 5.06.F. If Contractor or anyone for whom Contractor is responsible created the Hazardous Environmental Condition in question, then Owner may remove and remediate the Hazardous Environmental Condition, and impose a set-off against payments to account for the associated costs.
- F. Contractor shall not resume Work in connection with such Hazardous Environmental Condition or in any affected area until after Owner has obtained any required permits related thereto, and delivered written notice to Contractor either (1) specifying that such condition and any affected area is or has been rendered safe for the resumption of Work, or (2) specifying any special conditions under which such Work may be resumed safely.
- G. If Owner and Contractor cannot agree as to entitlement to or on the amount or extent, if any, of any adjustment in Contract Price or Contract Times, as a result of such Work stoppage, such special conditions under which Work is agreed to be resumed by Contractor, or any costs or expenses incurred in response to the Hazardous Environmental Condition, then within 30 days of Owner's written notice regarding the resumption of Work, Contractor may submit a Change Proposal, or Owner may impose a set-off. Entitlement to any such adjustment is subject to the provisions of Paragraphs 4.05.D, 4.05.E, 11.07, and 11.08.
- H. If, after receipt of such written notice, Contractor does not agree to resume such Work based on a reasonable belief it is unsafe, or does not agree to resume such Work under such special

conditions, then Owner may order the portion of the Work that is in the area affected by such condition to be deleted from the Work, following the contractual change procedures in Article 11. Owner may have such deleted portion of the Work performed by Owner's own forces or others in accordance with Article 8.

- I. To the fullest extent permitted by Laws and Regulations, Owner shall indemnify and hold harmless Contractor, Subcontractors, and Engineer, and the officers, directors, members, partners, employees, agents, consultants, and subcontractors of each and any of them, from and against all claims, costs, losses, and damages (including but not limited to all fees and charges of engineers, architects, attorneys, and other professionals, and all court, arbitration, or other dispute resolution costs) arising out of or relating to a Hazardous Environmental Condition, provided that such Hazardous Environmental Condition (1) was not shown or indicated in the Drawings, Specifications, or other Contract Documents, identified as Technical Data entitled to limited reliance pursuant to Paragraph 5.06.B, or identified in the Contract Documents to be included within the scope of the Work, and (2) was not created by Contractor or by anyone for whom Contractor is responsible. Nothing in this Paragraph 5.06.I obligates Owner to indemnify any individual or entity from and against the consequences of that individual's or entity's own negligence.
- J. To the fullest extent permitted by Laws and Regulations, Contractor shall indemnify and hold harmless Owner and Engineer, and the officers, directors, members, partners, employees, agents, consultants, and subcontractors of each and any of them, from and against all claims, costs, losses, and damages (including but not limited to all fees and charges of engineers, architects, attorneys, and other professionals and all court or arbitration or other dispute resolution costs) arising out of or relating to the failure to control, contain, or remove a Constituent of Concern brought to the Site by Contractor or by anyone for whom Contractor is responsible, or to a Hazardous Environmental Condition created by Contractor or by anyone for whom Contractor is responsible. Nothing in this Paragraph 5.06.J obligates Contractor to indemnify any individual or entity from and against the consequences of that individual's or entity's own negligence.
- K. The provisions of Paragraphs 5.03, 5.04, and 5.05 do not apply to the presence of Constituents of Concern or to a Hazardous Environmental Condition uncovered or revealed at the Site.

## **ARTICLE 6—BONDS AND INSURANCE**

### **6.01 *Performance, Payment, and Other Bonds***

- A. Contractor shall furnish a performance bond and a payment bond, each in an amount at least equal to the Contract Price, as security for the faithful performance and payment of Contractor's obligations under the Contract. These bonds must remain in effect until one year after the date when final payment becomes due or until completion of the correction period specified in Paragraph 15.08, whichever is later, except as provided otherwise by Laws or Regulations, the terms of a prescribed bond form, the Supplementary Conditions, or other provisions of the Contract.
- B. Contractor shall also furnish such other bonds (if any) as are required by the Supplementary Conditions or other provisions of the Contract.
- C. All bonds must be in the form included in the Bidding Documents or otherwise specified by Owner prior to execution of the Contract, except as provided otherwise by Laws or

Regulations, and must be issued and signed by a surety named in “Companies Holding Certificates of Authority as Acceptable Sureties on Federal Bonds and as Acceptable Reinsuring Companies” as published in Department Circular 570 (as amended and supplemented) by the Bureau of the Fiscal Service, U.S. Department of the Treasury. A bond signed by an agent or attorney-in-fact must be accompanied by a certified copy of that individual’s authority to bind the surety. The evidence of authority must show that it is effective on the date the agent or attorney-in-fact signed the accompanying bond.

- D. Contractor shall obtain the required bonds from surety companies that are duly licensed or authorized, in the state or jurisdiction in which the Project is located, to issue bonds in the required amounts.
- E. If the surety on a bond furnished by Contractor is declared bankrupt or becomes insolvent, or the surety ceases to meet the requirements above, then Contractor shall promptly notify Owner and Engineer in writing and shall, within 20 days after the event giving rise to such notification, provide another bond and surety, both of which must comply with the bond and surety requirements above.
- F. If Contractor has failed to obtain a required bond, Owner may exclude the Contractor from the Site and exercise Owner’s termination rights under Article 16.
- G. Upon request to Owner from any Subcontractor, Supplier, or other person or entity claiming to have furnished labor, services, materials, or equipment used in the performance of the Work, Owner shall provide a copy of the payment bond to such person or entity.
- H. Upon request to Contractor from any Subcontractor, Supplier, or other person or entity claiming to have furnished labor, services, materials, or equipment used in the performance of the Work, Contractor shall provide a copy of the payment bond to such person or entity.

#### 6.02 *Insurance—General Provisions*

- A. Owner and Contractor shall obtain and maintain insurance as required in this article and in the Supplementary Conditions.
- B. All insurance required by the Contract to be purchased and maintained by Owner or Contractor shall be obtained from insurance companies that are duly licensed or authorized in the state or jurisdiction in which the Project is located to issue insurance policies for the required limits and coverages. Unless a different standard is indicated in the Supplementary Conditions, all companies that provide insurance policies required under this Contract shall have an A.M. Best rating of A-VII or better.
- C. Alternative forms of insurance coverage, including but not limited to self-insurance and “Occupational Accident and Excess Employer’s Indemnity Policies,” are not sufficient to meet the insurance requirements of this Contract, unless expressly allowed in the Supplementary Conditions.
- D. Contractor shall deliver to Owner, with copies to each additional insured identified in the Contract, certificates of insurance and endorsements establishing that Contractor has obtained and is maintaining the policies and coverages required by the Contract. Upon request by Owner or any other insured, Contractor shall also furnish other evidence of such required insurance, including but not limited to copies of policies, documentation of applicable self-insured retentions (if allowed) and deductibles, full disclosure of all relevant exclusions, and evidence of insurance required to be purchased and maintained by



- Subcontractors or Suppliers. In any documentation furnished under this provision, Contractor, Subcontractors, and Suppliers may block out (redact) (1) any confidential premium or pricing information and (2) any wording specific to a project or jurisdiction other than those applicable to this Contract.
- E. Owner shall deliver to Contractor, with copies to each additional insured identified in the Contract, certificates of insurance and endorsements establishing that Owner has obtained and is maintaining the policies and coverages required of Owner by the Contract (if any). Upon request by Contractor or any other insured, Owner shall also provide other evidence of such required insurance (if any), including but not limited to copies of policies, documentation of applicable self-insured retentions (if allowed) and deductibles, and full disclosure of all relevant exclusions. In any documentation furnished under this provision, Owner may block out (redact) (1) any confidential premium or pricing information and (2) any wording specific to a project or jurisdiction other than those relevant to this Contract.
  - F. Failure of Owner or Contractor to demand such certificates or other evidence of the other party's full compliance with these insurance requirements, or failure of Owner or Contractor to identify a deficiency in compliance from the evidence provided, will not be construed as a waiver of the other party's obligation to obtain and maintain such insurance.
  - G. In addition to the liability insurance required to be provided by Contractor, the Owner, at Owner's option, may purchase and maintain Owner's own liability insurance. Owner's liability policies, if any, operate separately and independently from policies required to be provided by Contractor, and Contractor cannot rely upon Owner's liability policies for any of Contractor's obligations to the Owner, Engineer, or third parties.
  - H. Contractor shall require:
    - 1. Subcontractors to purchase and maintain worker's compensation, commercial general liability, and other insurance that is appropriate for their participation in the Project, and to name as additional insureds Owner and Engineer (and any other individuals or entities identified in the Supplementary Conditions as additional insureds on Contractor's liability policies) on each Subcontractor's commercial general liability insurance policy; and
    - 2. Suppliers to purchase and maintain insurance that is appropriate for their participation in the Project.
  - I. If either party does not purchase or maintain the insurance required of such party by the Contract, such party shall notify the other party in writing of such failure to purchase prior to the start of the Work, or of such failure to maintain prior to any change in the required coverage.
  - J. If Contractor has failed to obtain and maintain required insurance, Contractor's entitlement to enter or remain at the Site will end immediately, and Owner may impose an appropriate set-off against payment for any associated costs (including but not limited to the cost of purchasing necessary insurance coverage), and exercise Owner's termination rights under Article 16.
  - K. Without prejudice to any other right or remedy, if a party has failed to obtain required insurance, the other party may elect (but is in no way obligated) to obtain equivalent insurance to protect such other party's interests at the expense of the party who was required to provide such coverage, and the Contract Price will be adjusted accordingly.

- L. Owner does not represent that insurance coverage and limits established in this Contract necessarily will be adequate to protect Contractor or Contractor's interests. Contractor is responsible for determining whether such coverage and limits are adequate to protect its interests, and for obtaining and maintaining any additional insurance that Contractor deems necessary.
- M. The insurance and insurance limits required herein will not be deemed as a limitation on Contractor's liability, or that of its Subcontractors or Suppliers, under the indemnities granted to Owner and other individuals and entities in the Contract or otherwise.
- N. All the policies of insurance required to be purchased and maintained under this Contract will contain a provision or endorsement that the coverage afforded will not be canceled, or renewal refused, until at least 10 days prior written notice has been given to the purchasing policyholder. Within three days of receipt of any such written notice, the purchasing policyholder shall provide a copy of the notice to each other insured and Engineer.

6.03 *Contractor's Insurance*

- A. *Required Insurance:* Contractor shall purchase and maintain Worker's Compensation, Commercial General Liability, and other insurance pursuant to the specific requirements of the Supplementary Conditions.
- B. *General Provisions:* The policies of insurance required by this Paragraph 6.03 as supplemented must:
  - 1. include at least the specific coverages required;
  - 2. be written for not less than the limits provided, or those required by Laws or Regulations, whichever is greater;
  - 3. remain in effect at least until the Work is complete (as set forth in Paragraph 15.06.D), and longer if expressly required elsewhere in this Contract, and at all times thereafter when Contractor may be correcting, removing, or replacing defective Work as a warranty or correction obligation, or otherwise, or returning to the Site to conduct other tasks arising from the Contract;
  - 4. apply with respect to the performance of the Work, whether such performance is by Contractor, any Subcontractor or Supplier, or by anyone directly or indirectly employed by any of them to perform any of the Work, or by anyone for whose acts any of them may be liable; and
  - 5. include all necessary endorsements to support the stated requirements.
- C. *Additional Insureds:* The Contractor's commercial general liability, automobile liability, employer's liability, umbrella or excess, pollution liability, and unmanned aerial vehicle liability policies, if required by this Contract, must:
  - 1. include and list as additional insureds Owner and Engineer, and any individuals or entities identified as additional insureds in the Supplementary Conditions;
  - 2. include coverage for the respective officers, directors, members, partners, employees, and consultants of all such additional insureds;
  - 3. afford primary coverage to these additional insureds for all claims covered thereby (including as applicable those arising from both ongoing and completed operations);

4. not seek contribution from insurance maintained by the additional insured; and
5. as to commercial general liability insurance, apply to additional insureds with respect to liability caused in whole or in part by Contractor's acts or omissions, or the acts and omissions of those working on Contractor's behalf, in the performance of Contractor's operations.

#### 6.04 *Builder's Risk and Other Property Insurance*

- A. *Builder's Risk*: Unless otherwise provided in the Supplementary Conditions, Contractor shall purchase and maintain builder's risk insurance upon the Work on a completed value basis, in the amount of the Work's full insurable replacement cost (subject to such deductible amounts as may be provided in the Supplementary Conditions or required by Laws and Regulations). The specific requirements applicable to the builder's risk insurance are set forth in the Supplementary Conditions.
- B. *Property Insurance for Facilities of Owner Where Work Will Occur*: Owner is responsible for obtaining and maintaining property insurance covering each existing structure, building, or facility in which any part of the Work will occur, or to which any part of the Work will attach or be adjoined. Such property insurance will be written on a special perils (all-risk) form, on a replacement cost basis, providing coverage consistent with that required for the builder's risk insurance, and will be maintained until the Work is complete, as set forth in Paragraph 15.06.D.
- C. *Property Insurance for Substantially Complete Facilities*: Promptly after Substantial Completion, and before actual occupancy or use of the substantially completed Work, Owner will obtain property insurance for such substantially completed Work, and maintain such property insurance at least until the Work is complete, as set forth in Paragraph 15.06.D. Such property insurance will be written on a special perils (all-risk) form, on a replacement cost basis, and provide coverage consistent with that required for the builder's risk insurance. The builder's risk insurance may terminate upon written confirmation of Owner's procurement of such property insurance.
- D. *Partial Occupancy or Use by Owner*: If Owner will occupy or use a portion or portions of the Work prior to Substantial Completion of all the Work, as provided in Paragraph 15.04, then Owner (directly, if it is the purchaser of the builder's risk policy, or through Contractor) will provide advance notice of such occupancy or use to the builder's risk insurer, and obtain an endorsement consenting to the continuation of coverage prior to commencing such partial occupancy or use.
- E. *Insurance of Other Property; Additional Insurance*: If the express insurance provisions of the Contract do not require or address the insurance of a property item or interest, then the entity or individual owning such property item will be responsible for insuring it. If Contractor elects to obtain other special insurance to be included in or supplement the builder's risk or property insurance policies provided under this Paragraph 6.04, it may do so at Contractor's expense.

#### 6.05 *Property Losses; Subrogation*

- A. The builder's risk insurance policy purchased and maintained in accordance with Paragraph 6.04 (or an installation floater policy if authorized by the Supplementary Conditions), will contain provisions to the effect that in the event of payment of any loss or damage the insurer will have no rights of recovery against any insureds thereunder, or against

Engineer or its consultants, or their officers, directors, members, partners, employees, agents, consultants, or subcontractors.

1. Owner and Contractor waive all rights against each other and the respective officers, directors, members, partners, employees, agents, consultants, and subcontractors of each and any of them, for all losses and damages caused by, arising out of, or resulting from any of the perils, risks, or causes of loss covered by such policies and any other property insurance applicable to the Work; and, in addition, waive all such rights against Engineer, its consultants, all individuals or entities identified in the Supplementary Conditions as builder's risk or installation floater insureds, and the officers, directors, members, partners, employees, agents, consultants, and subcontractors of each and any of them, under such policies for losses and damages so caused.
  2. None of the above waivers extends to the rights that any party making such waiver may have to the proceeds of insurance held by Owner or Contractor as trustee or fiduciary, or otherwise payable under any policy so issued.
- B. Any property insurance policy maintained by Owner covering any loss, damage, or consequential loss to Owner's existing structures, buildings, or facilities in which any part of the Work will occur, or to which any part of the Work will attach or adjoin; to adjacent structures, buildings, or facilities of Owner; or to part or all of the completed or substantially completed Work, during partial occupancy or use pursuant to Paragraph 15.04, after Substantial Completion pursuant to Paragraph 15.03, or after final payment pursuant to Paragraph 15.06, will contain provisions to the effect that in the event of payment of any loss or damage the insurer will have no rights of recovery against any insureds thereunder, or against Contractor, Subcontractors, or Engineer, or the officers, directors, members, partners, employees, agents, consultants, or subcontractors of each and any of them, and that the insured is allowed to waive the insurer's rights of subrogation in a written contract executed prior to the loss, damage, or consequential loss.
1. Owner waives all rights against Contractor, Subcontractors, and Engineer, and the officers, directors, members, partners, employees, agents, consultants and subcontractors of each and any of them, for all losses and damages caused by, arising out of, or resulting from fire or any of the perils, risks, or causes of loss covered by such policies.
- C. The waivers in this Paragraph 6.05 include the waiver of rights due to business interruption, loss of use, or other consequential loss extending beyond direct physical loss or damage to Owner's property or the Work caused by, arising out of, or resulting from fire or other insured peril, risk, or cause of loss.
- D. Contractor shall be responsible for assuring that each Subcontract contains provisions whereby the Subcontractor waives all rights against Owner, Contractor, all individuals or entities identified in the Supplementary Conditions as insureds, the Engineer and its consultants, and the officers, directors, members, partners, employees, agents, consultants, and subcontractors of each and any of them, for all losses and damages caused by, arising out of, relating to, or resulting from fire or other peril, risk, or cause of loss covered by builder's risk insurance, installation floater, and any other property insurance applicable to the Work.

6.06 *Receipt and Application of Property Insurance Proceeds*

- A. Any insured loss under the builder's risk and other policies of property insurance required by Paragraph 6.04 will be adjusted and settled with the named insured that purchased the policy. Such named insured shall act as fiduciary for the other insureds, and give notice to such other insureds that adjustment and settlement of a claim is in progress. Any other insured may state its position regarding a claim for insured loss in writing within 15 days after notice of such claim.
- B. Proceeds for such insured losses may be made payable by the insurer either jointly to multiple insureds, or to the named insured that purchased the policy in its own right and as fiduciary for other insureds, subject to the requirements of any applicable mortgage clause. A named insured receiving insurance proceeds under the builder's risk and other policies of insurance required by Paragraph 6.04 shall maintain such proceeds in a segregated account, and distribute such proceeds in accordance with such agreement as the parties in interest may reach, or as otherwise required under the dispute resolution provisions of this Contract or applicable Laws and Regulations.
- C. If no other special agreement is reached, Contractor shall repair or replace the damaged Work, using allocated insurance proceeds.

**ARTICLE 7—CONTRACTOR'S RESPONSIBILITIES**

7.01 *Contractor's Means and Methods of Construction*

- A. Contractor shall be solely responsible for the means, methods, techniques, sequences, and procedures of construction.
- B. If the Contract Documents note, or Contractor determines, that professional engineering or other design services are needed to carry out Contractor's responsibilities for construction means, methods, techniques, sequences, and procedures, or for Site safety, then Contractor shall cause such services to be provided by a properly licensed design professional, at Contractor's expense. Such services are not Owner-delegated professional design services under this Contract, and neither Owner nor Engineer has any responsibility with respect to (1) Contractor's determination of the need for such services, (2) the qualifications or licensing of the design professionals retained or employed by Contractor, (3) the performance of such services, or (4) any errors, omissions, or defects in such services.

7.02 *Supervision and Superintendence*

- A. Contractor shall supervise, inspect, and direct the Work competently and efficiently, devoting such attention thereto and applying such skills and expertise as may be necessary to perform the Work in accordance with the Contract Documents.
- B. At all times during the progress of the Work, Contractor shall assign a competent resident superintendent who will not be replaced without written notice to Owner and Engineer except under extraordinary circumstances.

7.03 *Labor; Working Hours*

- A. Contractor shall provide competent, suitably qualified personnel to survey and lay out the Work and perform construction as required by the Contract Documents. Contractor shall maintain good discipline and order at the Site.

- B. Contractor shall be fully responsible to Owner and Engineer for all acts and omissions of Contractor's employees; of Suppliers and Subcontractors, and their employees; and of any other individuals or entities performing or furnishing any of the Work, just as Contractor is responsible for Contractor's own acts and omissions.
- C. Except as otherwise required for the safety or protection of persons or the Work or property at the Site or adjacent thereto, and except as otherwise stated in the Contract Documents, all Work at the Site will be performed during regular working hours, Monday through Friday. Contractor will not perform Work on a Saturday, Sunday, or any legal holiday. Contractor may perform Work outside regular working hours or on Saturdays, Sundays, or legal holidays only with Owner's written consent, which will not be unreasonably withheld.

#### 7.04 *Services, Materials, and Equipment*

- A. Unless otherwise specified in the Contract Documents, Contractor shall provide and assume full responsibility for all services, materials, equipment, labor, transportation, construction equipment and machinery, tools, appliances, fuel, power, light, heat, telephone, water, sanitary facilities, temporary facilities, and all other facilities and incidentals necessary for the performance, testing, start up, and completion of the Work, whether or not such items are specifically called for in the Contract Documents.
- B. All materials and equipment incorporated into the Work must be new and of good quality, except as otherwise provided in the Contract Documents. All special warranties and guarantees required by the Specifications will expressly run to the benefit of Owner. If required by Engineer, Contractor shall furnish satisfactory evidence (including reports of required tests) as to the source, kind, and quality of materials and equipment.
- C. All materials and equipment must be stored, applied, installed, connected, erected, protected, used, cleaned, and conditioned in accordance with instructions of the applicable Supplier, except as otherwise may be provided in the Contract Documents.

#### 7.05 *"Or Equals"*

- A. *Contractor's Request; Governing Criteria:* Whenever an item of equipment or material is specified or described in the Contract Documents by using the names of one or more proprietary items or specific Suppliers, the Contract Price has been based upon Contractor furnishing such item as specified. The specification or description of such an item is intended to establish the type, function, appearance, and quality required. Unless the specification or description contains or is followed by words reading that no like, equivalent, or "or equal" item is permitted, Contractor may request that Engineer authorize the use of other items of equipment or material, or items from other proposed Suppliers, under the circumstances described below.
  - 1. If Engineer in its sole discretion determines that an item of equipment or material proposed by Contractor is functionally equal to that named and sufficiently similar so that no change in related Work will be required, Engineer will deem it an "or equal" item. For the purposes of this paragraph, a proposed item of equipment or material will be considered functionally equal to an item so named if:
    - a. in the exercise of reasonable judgment Engineer determines that the proposed item:
      - 1) is at least equal in materials of construction, quality, durability, appearance, strength, and design characteristics;

- 2) will reliably perform at least equally well the function and achieve the results imposed by the design concept of the completed Project as a functioning whole;
  - 3) has a proven record of performance and availability of responsive service; and
  - 4) is not objectionable to Owner.
- b. Contractor certifies that, if the proposed item is approved and incorporated into the Work:
- 1) there will be no increase in cost to the Owner or increase in Contract Times; and
  - 2) the item will conform substantially to the detailed requirements of the item named in the Contract Documents.
- B. *Contractor's Expense*: Contractor shall provide all data in support of any proposed "or equal" item at Contractor's expense.
- C. *Engineer's Evaluation and Determination*: Engineer will be allowed a reasonable time to evaluate each "or-equal" request. Engineer may require Contractor to furnish additional data about the proposed "or-equal" item. Engineer will be the sole judge of acceptability. No "or-equal" item will be ordered, furnished, installed, or utilized until Engineer's review is complete and Engineer determines that the proposed item is an "or-equal," which will be evidenced by an approved Shop Drawing or other written communication. Engineer will advise Contractor in writing of any negative determination.
- D. *Effect of Engineer's Determination*: Neither approval nor denial of an "or-equal" request will result in any change in Contract Price. The Engineer's denial of an "or-equal" request will be final and binding, and may not be reversed through an appeal under any provision of the Contract.
- E. *Treatment as a Substitution Request*: If Engineer determines that an item of equipment or material proposed by Contractor does not qualify as an "or-equal" item, Contractor may request that Engineer consider the item a proposed substitute pursuant to Paragraph 7.06.

#### 7.06 *Substitutes*

- A. *Contractor's Request; Governing Criteria*: Unless the specification or description of an item of equipment or material required to be furnished under the Contract Documents contains or is followed by words reading that no substitution is permitted, Contractor may request that Engineer authorize the use of other items of equipment or material under the circumstances described below. To the extent possible such requests must be made before commencement of related construction at the Site.
1. Contractor shall submit sufficient information as provided below to allow Engineer to determine if the item of material or equipment proposed is functionally equivalent to that named and an acceptable substitute therefor. Engineer will not accept requests for review of proposed substitute items of equipment or material from anyone other than Contractor.
  2. The requirements for review by Engineer will be as set forth in Paragraph 7.06.B, as supplemented by the Specifications, and as Engineer may decide is appropriate under the circumstances.

3. Contractor shall make written application to Engineer for review of a proposed substitute item of equipment or material that Contractor seeks to furnish or use. The application:
  - a. will certify that the proposed substitute item will:
    - 1) perform adequately the functions and achieve the results called for by the general design;
    - 2) be similar in substance to the item specified; and
    - 3) be suited to the same use as the item specified.
  - b. will state:
    - 1) the extent, if any, to which the use of the proposed substitute item will necessitate a change in Contract Times;
    - 2) whether use of the proposed substitute item in the Work will require a change in any of the Contract Documents (or in the provisions of any other direct contract with Owner for other work on the Project) to adapt the design to the proposed substitute item; and
    - 3) whether incorporation or use of the proposed substitute item in connection with the Work is subject to payment of any license fee or royalty.
  - c. will identify:
    - 1) all variations of the proposed substitute item from the item specified; and
    - 2) available engineering, sales, maintenance, repair, and replacement services.
  - d. will contain an itemized estimate of all costs or credits that will result directly or indirectly from use of such substitute item, including but not limited to changes in Contract Price, shared savings, costs of redesign, and claims of other contractors affected by any resulting change.
- B. *Engineer's Evaluation and Determination:* Engineer will be allowed a reasonable time to evaluate each substitute request, and to obtain comments and direction from Owner. Engineer may require Contractor to furnish additional data about the proposed substitute item. Engineer will be the sole judge of acceptability. No substitute will be ordered, furnished, installed, or utilized until Engineer's review is complete and Engineer determines that the proposed item is an acceptable substitute. Engineer's determination will be evidenced by a Field Order or a proposed Change Order accounting for the substitution itself and all related impacts, including changes in Contract Price or Contract Times. Engineer will advise Contractor in writing of any negative determination.
- C. *Special Guarantee:* Owner may require Contractor to furnish at Contractor's expense a special performance guarantee or other surety with respect to any substitute.
- D. *Reimbursement of Engineer's Cost:* Engineer will record Engineer's costs in evaluating a substitute proposed or submitted by Contractor. Whether or not Engineer approves a substitute so proposed or submitted by Contractor, Contractor shall reimburse Owner for the reasonable charges of Engineer for evaluating each such proposed substitute. Contractor shall also reimburse Owner for the reasonable charges of Engineer for making changes in the Contract Documents (or in the provisions of any other direct contract with Owner) resulting from the acceptance of each proposed substitute.



- E. *Contractor's Expense*: Contractor shall provide all data in support of any proposed substitute at Contractor's expense.
- F. *Effect of Engineer's Determination*: If Engineer approves the substitution request, Contractor shall execute the proposed Change Order and proceed with the substitution. The Engineer's denial of a substitution request will be final and binding, and may not be reversed through an appeal under any provision of the Contract. Contractor may challenge the scope of reimbursement costs imposed under Paragraph 7.06.D, by timely submittal of a Change Proposal.

7.07 *Concerning Subcontractors and Suppliers*

- A. Contractor may retain Subcontractors and Suppliers for the performance of parts of the Work. Such Subcontractors and Suppliers must be acceptable to Owner. The Contractor's retention of a Subcontractor or Supplier for the performance of parts of the Work will not relieve Contractor's obligation to Owner to perform and complete the Work in accordance with the Contract Documents.
- B. Contractor shall retain specific Subcontractors and Suppliers for the performance of designated parts of the Work if required by the Contract to do so.
- C. Subsequent to the submittal of Contractor's Bid or final negotiation of the terms of the Contract, Owner may not require Contractor to retain any Subcontractor or Supplier to furnish or perform any of the Work against which Contractor has reasonable objection.
- D. Prior to entry into any binding subcontract or purchase order, Contractor shall submit to Owner the identity of the proposed Subcontractor or Supplier (unless Owner has already deemed such proposed Subcontractor or Supplier acceptable during the bidding process or otherwise). Such proposed Subcontractor or Supplier shall be deemed acceptable to Owner unless Owner raises a substantive, reasonable objection within 5 days.
- E. Owner may require the replacement of any Subcontractor or Supplier. Owner also may require Contractor to retain specific replacements; provided, however, that Owner may not require a replacement to which Contractor has a reasonable objection. If Contractor has submitted the identity of certain Subcontractors or Suppliers for acceptance by Owner, and Owner has accepted it (either in writing or by failing to make written objection thereto), then Owner may subsequently revoke the acceptance of any such Subcontractor or Supplier so identified solely on the basis of substantive, reasonable objection after due investigation. Contractor shall submit an acceptable replacement for the rejected Subcontractor or Supplier.
- F. If Owner requires the replacement of any Subcontractor or Supplier retained by Contractor to perform any part of the Work, then Contractor shall be entitled to an adjustment in Contract Price or Contract Times, with respect to the replacement; and Contractor shall initiate a Change Proposal for such adjustment within 30 days of Owner's requirement of replacement.
- G. No acceptance by Owner of any such Subcontractor or Supplier, whether initially or as a replacement, will constitute a waiver of the right of Owner to the completion of the Work in accordance with the Contract Documents.

- H. On a monthly basis, Contractor shall submit to Engineer a complete list of all Subcontractors and Suppliers having a direct contract with Contractor, and of all other Subcontractors and Suppliers known to Contractor at the time of submittal.
- I. Contractor shall be solely responsible for scheduling and coordinating the work of Subcontractors and Suppliers.
- J. The divisions and sections of the Specifications and the identifications of any Drawings do not control Contractor in dividing the Work among Subcontractors or Suppliers, or in delineating the Work to be performed by any specific trade.
- K. All Work performed for Contractor by a Subcontractor or Supplier must be pursuant to an appropriate contractual agreement that specifically binds the Subcontractor or Supplier to the applicable terms and conditions of the Contract for the benefit of Owner and Engineer.
- L. Owner may furnish to any Subcontractor or Supplier, to the extent practicable, information about amounts paid to Contractor for Work performed for Contractor by the Subcontractor or Supplier.
- M. Contractor shall restrict all Subcontractors and Suppliers from communicating with Engineer or Owner, except through Contractor or in case of an emergency, or as otherwise expressly allowed in this Contract.

7.08 *Patent Fees and Royalties*

- A. Contractor shall pay all license fees and royalties and assume all costs incident to the use in the performance of the Work or the incorporation in the Work of any invention, design, process, product, or device which is the subject of patent rights or copyrights held by others. If an invention, design, process, product, or device is specified in the Contract Documents for use in the performance of the Work and if, to the actual knowledge of Owner or Engineer, its use is subject to patent rights or copyrights calling for the payment of any license fee or royalty to others, the existence of such rights will be disclosed in the Contract Documents.
- B. To the fullest extent permitted by Laws and Regulations, Owner shall indemnify and hold harmless Contractor, and its officers, directors, members, partners, employees, agents, consultants, and subcontractors, from and against all claims, costs, losses, and damages (including but not limited to all fees and charges of engineers, architects, attorneys, and other professionals, and all court or arbitration or other dispute resolution costs) arising out of or relating to any infringement of patent rights or copyrights incident to the use in the performance of the Work or resulting from the incorporation in the Work of any invention, design, process, product, or device specified in the Contract Documents, but not identified as being subject to payment of any license fee or royalty to others required by patent rights or copyrights.
- C. To the fullest extent permitted by Laws and Regulations, Contractor shall indemnify and hold harmless Owner and Engineer, and the officers, directors, members, partners, employees, agents, consultants and subcontractors of each and any of them, from and against all claims, costs, losses, and damages (including but not limited to all fees and charges of engineers, architects, attorneys, and other professionals and all court or arbitration or other dispute resolution costs) arising out of or relating to any infringement of patent rights or copyrights incident to the use in the performance of the Work or resulting from the incorporation in the Work of any invention, design, process, product, or device not specified in the Contract Documents.

#### 7.09 *Permits*

- A. Unless otherwise provided in the Contract Documents, Contractor shall obtain and pay for all construction permits, licenses, and certificates of occupancy. Owner shall assist Contractor, when necessary, in obtaining such permits and licenses. Contractor shall pay all governmental charges and inspection fees necessary for the prosecution of the Work which are applicable at the time of the submission of Contractor's Bid (or when Contractor became bound under a negotiated contract). Owner shall pay all charges of utility owners for connections for providing permanent service to the Work.

#### 7.10 *Taxes*

- A. Contractor shall pay all sales, consumer, use, and other similar taxes required to be paid by Contractor in accordance with the Laws and Regulations of the place of the Project which are applicable during the performance of the Work.

#### 7.11 *Laws and Regulations*

- A. Contractor shall give all notices required by and shall comply with all Laws and Regulations applicable to the performance of the Work. Neither Owner nor Engineer shall be responsible for monitoring Contractor's compliance with any Laws or Regulations.
- B. If Contractor performs any Work or takes any other action knowing or having reason to know that it is contrary to Laws or Regulations, Contractor shall bear all resulting costs and losses, and shall indemnify and hold harmless Owner and Engineer, and the officers, directors, members, partners, employees, agents, consultants, and subcontractors of each and any of them, from and against all claims, costs, losses, and damages (including but not limited to all fees and charges of engineers, architects, attorneys, and other professionals and all court or arbitration or other dispute resolution costs) arising out of or relating to such Work or other action. It is not Contractor's responsibility to make certain that the Work described in the Contract Documents is in accordance with Laws and Regulations, but this does not relieve Contractor of its obligations under Paragraph 3.03.
- C. Owner or Contractor may give written notice to the other party of any changes after the submission of Contractor's Bid (or after the date when Contractor became bound under a negotiated contract) in Laws or Regulations having an effect on the cost or time of performance of the Work, including but not limited to changes in Laws or Regulations having an effect on procuring permits and on sales, use, value-added, consumption, and other similar taxes. If Owner and Contractor are unable to agree on entitlement to or on the amount or extent, if any, of any adjustment in Contract Price or Contract Times resulting from such changes, then within 30 days of such written notice Contractor may submit a Change Proposal, or Owner may initiate a Claim.

#### 7.12 *Record Documents*

- A. Contractor shall maintain in a safe place at the Site one printed record copy of all Drawings, Specifications, Addenda, Change Orders, Work Change Directives, Field Orders, written interpretations and clarifications, and approved Shop Drawings. Contractor shall keep such record documents in good order and annotate them to show changes made during construction. These record documents, together with all approved Samples, will be available to Engineer for reference. Upon completion of the Work, Contractor shall deliver these record documents to Engineer.

### 7.13 *Safety and Protection*

- A. Contractor shall be solely responsible for initiating, maintaining, and supervising all safety precautions and programs in connection with the Work. Such responsibility does not relieve Subcontractors of their responsibility for the safety of persons or property in the performance of their work, nor for compliance with applicable safety Laws and Regulations.
- B. Contractor shall designate a qualified and experienced safety representative whose duties and responsibilities are the prevention of Work-related accidents and the maintenance and supervision of safety precautions and programs.
- C. Contractor shall take all necessary precautions for the safety of, and shall provide the necessary protection to prevent damage, injury, or loss to:
  - 1. all persons on the Site or who may be affected by the Work;
  - 2. all the Work and materials and equipment to be incorporated therein, whether in storage on or off the Site; and
  - 3. other property at the Site or adjacent thereto, including trees, shrubs, lawns, walks, pavements, roadways, structures, other work in progress, utilities, and Underground Facilities not designated for removal, relocation, or replacement in the course of construction.
- D. All damage, injury, or loss to any property referred to in Paragraph 7.13.C.2 or 7.13.C.3 caused, directly or indirectly, in whole or in part, by Contractor, any Subcontractor, Supplier, or any other individual or entity directly or indirectly employed by any of them to perform any of the Work, or anyone for whose acts any of them may be liable, shall be remedied by Contractor at its expense (except damage or loss attributable to the fault of Drawings or Specifications or to the acts or omissions of Owner or Engineer or anyone employed by any of them, or anyone for whose acts any of them may be liable, and not attributable, directly or indirectly, in whole or in part, to the fault or negligence of Contractor or any Subcontractor, Supplier, or other individual or entity directly or indirectly employed by any of them).
- E. Contractor shall comply with all applicable Laws and Regulations relating to the safety of persons or property, or to the protection of persons or property from damage, injury, or loss; and shall erect and maintain all necessary safeguards for such safety and protection.
- F. Contractor shall notify Owner; the owners of adjacent property; the owners of Underground Facilities and other utilities (if the identity of such owners is known to Contractor); and other contractors and utility owners performing work at or adjacent to the Site, in writing, when Contractor knows that prosecution of the Work may affect them, and shall cooperate with them in the protection, removal, relocation, and replacement of their property or work in progress.
- G. Contractor shall comply with the applicable requirements of Owner's safety programs, if any. Any Owner's safety programs that are applicable to the Work are identified or included in the Supplementary Conditions or Specifications.
- H. Contractor shall inform Owner and Engineer of the specific requirements of Contractor's safety program with which Owner's and Engineer's employees and representatives must comply while at the Site.

- I. Contractor's duties and responsibilities for safety and protection will continue until all the Work is completed, Engineer has issued a written notice to Owner and Contractor in accordance with Paragraph 15.06.C that the Work is acceptable, and Contractor has left the Site (except as otherwise expressly provided in connection with Substantial Completion).
- J. Contractor's duties and responsibilities for safety and protection will resume whenever Contractor or any Subcontractor or Supplier returns to the Site to fulfill warranty or correction obligations, or to conduct other tasks arising from the Contract Documents.

7.14 *Hazard Communication Programs*

- A. Contractor shall be responsible for coordinating any exchange of safety data sheets (formerly known as material safety data sheets) or other hazard communication information required to be made available to or exchanged between or among employers at the Site in accordance with Laws or Regulations.

7.15 *Emergencies*

- A. In emergencies affecting the safety or protection of persons or the Work or property at the Site or adjacent thereto, Contractor is obligated to act to prevent damage, injury, or loss. Contractor shall give Engineer prompt written notice if Contractor believes that any significant changes in the Work or variations from the Contract Documents have been caused by an emergency, or are required as a result of Contractor's response to an emergency. If Engineer determines that a change in the Contract Documents is required because of an emergency or Contractor's response, a Work Change Directive or Change Order will be issued.

7.16 *Submittals*

A. *Shop Drawing and Sample Requirements*

- 1. Before submitting a Shop Drawing or Sample, Contractor shall:
  - a. review and coordinate the Shop Drawing or Sample with other Shop Drawings and Samples and with the requirements of the Work and the Contract Documents;
  - b. determine and verify:
    - 1) all field measurements, quantities, dimensions, specified performance and design criteria, installation requirements, materials, catalog numbers, and similar information with respect to the Submittal;
    - 2) the suitability of all materials and equipment offered with respect to the indicated application, fabrication, shipping, handling, storage, assembly, and installation pertaining to the performance of the Work; and
    - 3) all information relative to Contractor's responsibilities for means, methods, techniques, sequences, and procedures of construction, and safety precautions and programs incident thereto;
  - c. confirm that the Submittal is complete with respect to all related data included in the Submittal.
- 2. Each Shop Drawing or Sample must bear a stamp or specific written certification that Contractor has satisfied Contractor's obligations under the Contract Documents with respect to Contractor's review of that Submittal, and that Contractor approves the Submittal.

3. With each Shop Drawing or Sample, Contractor shall give Engineer specific written notice of any variations that the Submittal may have from the requirements of the Contract Documents. This notice must be set forth in a written communication separate from the Submittal; and, in addition, in the case of a Shop Drawing by a specific notation made on the Shop Drawing itself.
- B. *Submittal Procedures for Shop Drawings and Samples:* Contractor shall label and submit Shop Drawings and Samples to Engineer for review and approval in accordance with the accepted Schedule of Submittals.
1. *Shop Drawings*
    - a. Contractor shall submit the number of copies required in the Specifications.
    - b. Data shown on the Shop Drawings must be complete with respect to quantities, dimensions, specified performance and design criteria, materials, and similar data to show Engineer the services, materials, and equipment Contractor proposes to provide, and to enable Engineer to review the information for the limited purposes required by Paragraph 7.16.C.
  2. *Samples*
    - a. Contractor shall submit the number of Samples required in the Specifications.
    - b. Contractor shall clearly identify each Sample as to material, Supplier, pertinent data such as catalog numbers, the use for which intended and other data as Engineer may require to enable Engineer to review the Submittal for the limited purposes required by Paragraph 7.16.C.
  3. Where a Shop Drawing or Sample is required by the Contract Documents or the Schedule of Submittals, any related Work performed prior to Engineer's review and approval of the pertinent submittal will be at the sole expense and responsibility of Contractor.
- C. *Engineer's Review of Shop Drawings and Samples*
1. Engineer will provide timely review of Shop Drawings and Samples in accordance with the accepted Schedule of Submittals. Engineer's review and approval will be only to determine if the items covered by the Submittals will, after installation or incorporation in the Work, comply with the requirements of the Contract Documents, and be compatible with the design concept of the completed Project as a functioning whole as indicated by the Contract Documents.
  2. Engineer's review and approval will not extend to means, methods, techniques, sequences, or procedures of construction, or to safety precautions or programs incident thereto.
  3. Engineer's review and approval of a separate item as such will not indicate approval of the assembly in which the item functions.
  4. Engineer's review and approval of a Shop Drawing or Sample will not relieve Contractor from responsibility for any variation from the requirements of the Contract Documents unless Contractor has complied with the requirements of Paragraph 7.16.A.3 and Engineer has given written approval of each such variation by specific written notation thereof incorporated in or accompanying the Shop Drawing or Sample. Engineer will

document any such approved variation from the requirements of the Contract Documents in a Field Order or other appropriate Contract modification.

5. Engineer's review and approval of a Shop Drawing or Sample will not relieve Contractor from responsibility for complying with the requirements of Paragraphs 7.16.A and B.
6. Engineer's review and approval of a Shop Drawing or Sample, or of a variation from the requirements of the Contract Documents, will not, under any circumstances, change the Contract Times or Contract Price, unless such changes are included in a Change Order.
7. Neither Engineer's receipt, review, acceptance, or approval of a Shop Drawing or Sample will result in such item becoming a Contract Document.
8. Contractor shall perform the Work in compliance with the requirements and commitments set forth in approved Shop Drawings and Samples, subject to the provisions of Paragraph 7.16.C.4.

*D. Resubmittal Procedures for Shop Drawings and Samples*

1. Contractor shall make corrections required by Engineer and shall return the required number of corrected copies of Shop Drawings and submit, as required, new Samples for review and approval. Contractor shall direct specific attention in writing to revisions other than the corrections called for by Engineer on previous Submittals.
2. Contractor shall furnish required Shop Drawing and Sample submittals with sufficient information and accuracy to obtain required approval of an item with no more than two resubmittals. Engineer will record Engineer's time for reviewing a third or subsequent resubmittal of a Shop Drawing or Sample, and Contractor shall be responsible for Engineer's charges to Owner for such time. Owner may impose a set-off against payments due Contractor to secure reimbursement for such charges.
3. If Contractor requests a change of a previously approved Shop Drawing or Sample, Contractor shall be responsible for Engineer's charges to Owner for its review time, and Owner may impose a set-off against payments due Contractor to secure reimbursement for such charges, unless the need for such change is beyond the control of Contractor.

*E. Submittals Other than Shop Drawings, Samples, and Owner-Delegated Designs*

1. The following provisions apply to all Submittals other than Shop Drawings, Samples, and Owner-delegated designs:
  - a. Contractor shall submit all such Submittals to the Engineer in accordance with the Schedule of Submittals and pursuant to the applicable terms of the Contract Documents.
  - b. Engineer will provide timely review of all such Submittals in accordance with the Schedule of Submittals and return such Submittals with a notation of either Accepted or Not Accepted. Any such Submittal that is not returned within the time established in the Schedule of Submittals will be deemed accepted.
  - c. Engineer's review will be only to determine if the Submittal is acceptable under the requirements of the Contract Documents as to general form and content of the Submittal.

- d. If any such Submittal is not accepted, Contractor shall confer with Engineer regarding the reason for the non-acceptance, and resubmit an acceptable document.
  2. Procedures for the submittal and acceptance of the Progress Schedule, the Schedule of Submittals, and the Schedule of Values are set forth in Paragraphs 2.03, 2.04, and 2.05.
- F. Owner-delegated Designs: Submittals pursuant to Owner-delegated designs are governed by the provisions of Paragraph 7.19.

**7.17 Contractor's General Warranty and Guarantee**

- A. Contractor warrants and guarantees to Owner that all Work will be in accordance with the Contract Documents and will not be defective. Engineer is entitled to rely on Contractor's warranty and guarantee.
- B. Owner's rights under this warranty and guarantee are in addition to, and are not limited by, Owner's rights under the correction period provisions of Paragraph 15.08. The time in which Owner may enforce its warranty and guarantee rights under this Paragraph 7.17 is limited only by applicable Laws and Regulations restricting actions to enforce such rights; provided, however, that after the end of the correction period under Paragraph 15.08:
1. Owner shall give Contractor written notice of any defective Work within 60 days of the discovery that such Work is defective; and
  2. Such notice will be deemed the start of an event giving rise to a Claim under Paragraph 12.01.B, such that any related Claim must be brought within 30 days of the notice.
- C. Contractor's warranty and guarantee hereunder excludes defects or damage caused by:
1. abuse, or improper modification, maintenance, or operation, by persons other than Contractor, Subcontractors, Suppliers, or any other individual or entity for whom Contractor is responsible; or
  2. normal wear and tear under normal usage.
- D. Contractor's obligation to perform and complete the Work in accordance with the Contract Documents is absolute. None of the following will constitute an acceptance of Work that is not in accordance with the Contract Documents, a release of Contractor's obligation to perform the Work in accordance with the Contract Documents, or a release of Owner's warranty and guarantee rights under this Paragraph 7.17:
1. Observations by Engineer;
  2. Recommendation by Engineer or payment by Owner of any progress or final payment;
  3. The issuance of a certificate of Substantial Completion by Engineer or any payment related thereto by Owner;
  4. Use or occupancy of the Work or any part thereof by Owner;
  5. Any review and approval of a Shop Drawing or Sample submittal;
  6. The issuance of a notice of acceptability by Engineer;
  7. The end of the correction period established in Paragraph 15.08;
  8. Any inspection, test, or approval by others; or



9. Any correction of defective Work by Owner.
- E. If the Contract requires the Contractor to accept the assignment of a contract entered into by Owner, then the specific warranties, guarantees, and correction obligations contained in the assigned contract will govern with respect to Contractor's performance obligations to Owner for the Work described in the assigned contract.

**7.18 Indemnification**

- A. To the fullest extent permitted by Laws and Regulations, and in addition to any other obligations of Contractor under the Contract or otherwise, Contractor shall indemnify and hold harmless Owner and Engineer, and the officers, directors, members, partners, employees, agents, consultants and subcontractors of each and any of them, from losses, damages, costs, and judgments (including but not limited to all fees and charges of engineers, architects, attorneys, and other professionals, and all court or arbitration or other dispute resolution costs) arising from third-party claims or actions relating to or resulting from the performance or furnishing of the Work, provided that any such claim, action, loss, cost, judgment or damage is attributable to bodily injury, sickness, disease, or death, or to damage to or destruction of tangible property (other than the Work itself), including the loss of use resulting therefrom, but only to the extent caused by any negligent act or omission of Contractor, any Subcontractor, any Supplier, or any individual or entity directly or indirectly employed by any of them to perform any of the Work, or anyone for whose acts any of them may be liable.
- B. In any and all claims against Owner or Engineer, or any of their officers, directors, members, partners, employees, agents, consultants, or subcontractors, by any employee (or the survivor or personal representative of such employee) of Contractor, any Subcontractor, any Supplier, or any individual or entity directly or indirectly employed by any of them to perform any of the Work, or anyone for whose acts any of them may be liable, the indemnification obligation under Paragraph 7.18.A will not be limited in any way by any limitation on the amount or type of damages, compensation, or benefits payable by or for Contractor or any such Subcontractor, Supplier, or other individual or entity under workers' compensation acts, disability benefit acts, or other employee benefit acts.

**7.19 Delegation of Professional Design Services**

- A. Owner may require Contractor to provide professional design services for a portion of the Work by express delegation in the Contract Documents. Such delegation will specify the performance and design criteria that such services must satisfy, and the Submittals that Contractor must furnish to Engineer with respect to the Owner-delegated design.
- B. Contractor shall cause such Owner-delegated professional design services to be provided pursuant to the professional standard of care by a properly licensed design professional, whose signature and seal must appear on all drawings, calculations, specifications, certifications, and Submittals prepared by such design professional. Such design professional must issue all certifications of design required by Laws and Regulations.
- C. If a Shop Drawing or other Submittal related to the Owner-delegated design is prepared by Contractor, a Subcontractor, or others for submittal to Engineer, then such Shop Drawing or other Submittal must bear the written approval of Contractor's design professional when submitted by Contractor to Engineer.

- D. Owner and Engineer shall be entitled to rely upon the adequacy, accuracy, and completeness of the services, certifications, and approvals performed or provided by the design professionals retained or employed by Contractor under an Owner-delegated design, subject to the professional standard of care and the performance and design criteria stated in the Contract Documents.
- E. Pursuant to this Paragraph 7.19, Engineer's review, approval, and other determinations regarding design drawings, calculations, specifications, certifications, and other Submittals furnished by Contractor pursuant to an Owner-delegated design will be only for the following limited purposes:
  - 1. Checking for conformance with the requirements of this Paragraph 7.19;
  - 2. Confirming that Contractor (through its design professionals) has used the performance and design criteria specified in the Contract Documents; and
  - 3. Establishing that the design furnished by Contractor is consistent with the design concept expressed in the Contract Documents.
- F. Contractor shall not be responsible for the adequacy of performance or design criteria specified by Owner or Engineer.
- G. Contractor is not required to provide professional services in violation of applicable Laws and Regulations.

## **ARTICLE 8—OTHER WORK AT THE SITE**

### **8.01 *Other Work***

- A. In addition to and apart from the Work under the Contract Documents, the Owner may perform other work at or adjacent to the Site. Such other work may be performed by Owner's employees, or through contracts between the Owner and third parties. Owner may also arrange to have third-party utility owners perform work on their utilities and facilities at or adjacent to the Site.
- B. If Owner performs other work at or adjacent to the Site with Owner's employees, or through contracts for such other work, then Owner shall give Contractor written notice thereof prior to starting any such other work. If Owner has advance information regarding the start of any third-party utility work that Owner has arranged to take place at or adjacent to the Site, Owner shall provide such information to Contractor.
- C. Contractor shall afford proper and safe access to the Site to each contractor that performs such other work, each utility owner performing other work, and Owner, if Owner is performing other work with Owner's employees, and provide a reasonable opportunity for the introduction and storage of materials and equipment and the execution of such other work.
- D. Contractor shall do all cutting, fitting, and patching of the Work that may be required to properly connect or otherwise make its several parts come together and properly integrate with such other work. Contractor shall not endanger any work of others by cutting, excavating, or otherwise altering such work; provided, however, that Contractor may cut or alter others' work with the written consent of Engineer and the others whose work will be affected.

- E. If the proper execution or results of any part of Contractor's Work depends upon work performed by others, Contractor shall inspect such other work and promptly report to Engineer in writing any delays, defects, or deficiencies in such other work that render it unavailable or unsuitable for the proper execution and results of Contractor's Work. Contractor's failure to so report will constitute an acceptance of such other work as fit and proper for integration with Contractor's Work except for latent defects and deficiencies in such other work.
- F. The provisions of this article are not applicable to work that is performed by third-party utilities or other third-party entities without a contract with Owner, or that is performed without having been arranged by Owner. If such work occurs, then any related delay, disruption, or interference incurred by Contractor is governed by the provisions of Paragraph 4.05.C.3.

#### 8.02 *Coordination*

- A. If Owner intends to contract with others for the performance of other work at or adjacent to the Site, to perform other work at or adjacent to the Site with Owner's employees, or to arrange to have utility owners perform work at or adjacent to the Site, the following will be set forth in the Supplementary Conditions or provided to Contractor prior to the start of any such other work:
  - 1. The identity of the individual or entity that will have authority and responsibility for coordination of the activities among the various contractors;
  - 2. An itemization of the specific matters to be covered by such authority and responsibility; and
  - 3. The extent of such authority and responsibilities.
- B. Unless otherwise provided in the Supplementary Conditions, Owner shall have sole authority and responsibility for such coordination.

#### 8.03 *Legal Relationships*

- A. If, in the course of performing other work for Owner at or adjacent to the Site, the Owner's employees, any other contractor working for Owner, or any utility owner that Owner has arranged to perform work, causes damage to the Work or to the property of Contractor or its Subcontractors, or delays, disrupts, interferes with, or increases the scope or cost of the performance of the Work, through actions or inaction, then Contractor shall be entitled to an equitable adjustment in the Contract Price or the Contract Times. Contractor must submit any Change Proposal seeking an equitable adjustment in the Contract Price or the Contract Times under this paragraph within 30 days of the damaging, delaying, disrupting, or interfering event. The entitlement to, and extent of, any such equitable adjustment will take into account information (if any) regarding such other work that was provided to Contractor in the Contract Documents prior to the submittal of the Bid or the final negotiation of the terms of the Contract, and any remedies available to Contractor under Laws or Regulations concerning utility action or inaction. When applicable, any such equitable adjustment in Contract Price will be conditioned on Contractor assigning to Owner all Contractor's rights against such other contractor or utility owner with respect to the damage, delay, disruption, or interference that is the subject of the adjustment. Contractor's entitlement to an adjustment of the Contract Times or Contract Price is subject to the provisions of Paragraphs 4.05.D and 4.05.E.

- B. Contractor shall take reasonable and customary measures to avoid damaging, delaying, disrupting, or interfering with the work of Owner, any other contractor, or any utility owner performing other work at or adjacent to the Site.
  - 1. If Contractor fails to take such measures and as a result damages, delays, disrupts, or interferes with the work of any such other contractor or utility owner, then Owner may impose a set-off against payments due Contractor, and assign to such other contractor or utility owner the Owner's contractual rights against Contractor with respect to the breach of the obligations set forth in this Paragraph 8.03.B.
  - 2. When Owner is performing other work at or adjacent to the Site with Owner's employees, Contractor shall be liable to Owner for damage to such other work, and for the reasonable direct delay, disruption, and interference costs incurred by Owner as a result of Contractor's failure to take reasonable and customary measures with respect to Owner's other work. In response to such damage, delay, disruption, or interference, Owner may impose a set-off against payments due Contractor.
- C. If Contractor damages, delays, disrupts, or interferes with the work of any other contractor, or any utility owner performing other work at or adjacent to the Site, through Contractor's failure to take reasonable and customary measures to avoid such impacts, or if any claim arising out of Contractor's actions, inactions, or negligence in performance of the Work at or adjacent to the Site is made by any such other contractor or utility owner against Contractor, Owner, or Engineer, then Contractor shall (1) promptly attempt to settle the claim as to all parties through negotiations with such other contractor or utility owner, or otherwise resolve the claim by arbitration or other dispute resolution proceeding or at law, and (2) indemnify and hold harmless Owner and Engineer, and the officers, directors, members, partners, employees, agents, consultants and subcontractors of each and any of them from and against any such claims, and against all costs, losses, and damages (including but not limited to all fees and charges of engineers, architects, attorneys, and other professionals and all court or arbitration or other dispute resolution costs) arising out of or relating to such damage, delay, disruption, or interference.

## **ARTICLE 9—OWNER'S RESPONSIBILITIES**

### **9.01 *Communications to Contractor***

- A. Except as otherwise provided in these General Conditions, Owner shall issue all communications to Contractor through Engineer.

### **9.02 *Replacement of Engineer***

- A. Owner may at its discretion appoint an engineer to replace Engineer, provided Contractor makes no reasonable objection to the replacement engineer. The replacement engineer's status under the Contract Documents will be that of the former Engineer.

### **9.03 *Furnish Data***

- A. Owner shall promptly furnish the data required of Owner under the Contract Documents.

### **9.04 *Pay When Due***

- A. Owner shall make payments to Contractor when they are due as provided in the Agreement.

- 9.05 *Lands and Easements; Reports, Tests, and Drawings*
- A. Owner's duties with respect to providing lands and easements are set forth in Paragraph 5.01.
  - B. Owner's duties with respect to providing engineering surveys to establish reference points are set forth in Paragraph 4.03.
  - C. Article 5 refers to Owner's identifying and making available to Contractor copies of reports of explorations and tests of conditions at the Site, and drawings of physical conditions relating to existing surface or subsurface structures at the Site.
- 9.06 *Insurance*
- A. Owner's responsibilities, if any, with respect to purchasing and maintaining liability and property insurance are set forth in Article 6.
- 9.07 *Change Orders*
- A. Owner's responsibilities with respect to Change Orders are set forth in Article 11.
- 9.08 *Inspections, Tests, and Approvals*
- A. Owner's responsibility with respect to certain inspections, tests, and approvals is set forth in Paragraph 14.02.B.
- 9.09 *Limitations on Owner's Responsibilities*
- A. The Owner shall not supervise, direct, or have control or authority over, nor be responsible for, Contractor's means, methods, techniques, sequences, or procedures of construction, or the safety precautions and programs incident thereto, or for any failure of Contractor to comply with Laws and Regulations applicable to the performance of the Work. Owner will not be responsible for Contractor's failure to perform the Work in accordance with the Contract Documents.
- 9.10 *Undisclosed Hazardous Environmental Condition*
- A. Owner's responsibility in respect to an undisclosed Hazardous Environmental Condition is set forth in Paragraph 5.06.
- 9.11 *Evidence of Financial Arrangements*
- A. Upon request of Contractor, Owner shall furnish Contractor reasonable evidence that financial arrangements have been made to satisfy Owner's obligations under the Contract (including obligations under proposed changes in the Work).
- 9.12 *Safety Programs*
- A. While at the Site, Owner's employees and representatives shall comply with the specific applicable requirements of Contractor's safety programs of which Owner has been informed.
  - B. Owner shall furnish copies of any applicable Owner safety programs to Contractor.

## ARTICLE 10—ENGINEER'S STATUS DURING CONSTRUCTION

### 10.01 *Owner's Representative*

- A. Engineer will be Owner's representative during the construction period. The duties and responsibilities and the limitations of authority of Engineer as Owner's representative during construction are set forth in the Contract.

### 10.02 *Visits to Site*

- A. Engineer will make visits to the Site at intervals appropriate to the various stages of construction as Engineer deems necessary in order to observe, as an experienced and qualified design professional, the progress that has been made and the quality of the various aspects of Contractor's executed Work. Based on information obtained during such visits and observations, Engineer, for the benefit of Owner, will determine, in general, if the Work is proceeding in accordance with the Contract Documents. Engineer will not be required to make exhaustive or continuous inspections on the Site to check the quality or quantity of the Work. Engineer's efforts will be directed toward providing for Owner a greater degree of confidence that the completed Work will conform generally to the Contract Documents. On the basis of such visits and observations, Engineer will keep Owner informed of the progress of the Work and will endeavor to guard Owner against defective Work.
- B. Engineer's visits and observations are subject to all the limitations on Engineer's authority and responsibility set forth in Paragraph 10.07. Particularly, but without limitation, during or as a result of Engineer's visits or observations of Contractor's Work, Engineer will not supervise, direct, control, or have authority over or be responsible for Contractor's means, methods, techniques, sequences, or procedures of construction, or the safety precautions and programs incident thereto, or for any failure of Contractor to comply with Laws and Regulations applicable to the performance of the Work.

### 10.03 *Resident Project Representative*

- A. If Owner and Engineer have agreed that Engineer will furnish a Resident Project Representative to represent Engineer at the Site and assist Engineer in observing the progress and quality of the Work, then the authority and responsibilities of any such Resident Project Representative will be as provided in the Supplementary Conditions, and limitations on the responsibilities thereof will be as provided in the Supplementary Conditions and in Paragraph 10.07.
- B. If Owner designates an individual or entity who is not Engineer's consultant, agent, or employee to represent Owner at the Site, then the responsibilities and authority of such individual or entity will be as provided in the Supplementary Conditions.

### 10.04 *Engineer's Authority*

- A. Engineer has the authority to reject Work in accordance with Article 14.
- B. Engineer's authority as to Submittals is set forth in Paragraph 7.16.
- C. Engineer's authority as to design drawings, calculations, specifications, certifications and other Submittals from Contractor in response to Owner's delegation (if any) to Contractor of professional design services, is set forth in Paragraph 7.19.
- D. Engineer's authority as to changes in the Work is set forth in Article 11.

E. Engineer's authority as to Applications for Payment is set forth in Article 15.

10.05 *Determinations for Unit Price Work*

A. Engineer will determine the actual quantities and classifications of Unit Price Work performed by Contractor as set forth in Paragraph 13.03.

10.06 *Decisions on Requirements of Contract Documents and Acceptability of Work*

A. Engineer will render decisions regarding the requirements of the Contract Documents, and judge the acceptability of the Work, pursuant to the specific procedures set forth herein for initial interpretations, Change Proposals, and acceptance of the Work. In rendering such decisions and judgments, Engineer will not show partiality to Owner or Contractor, and will not be liable to Owner, Contractor, or others in connection with any proceedings, interpretations, decisions, or judgments conducted or rendered in good faith.

10.07 *Limitations on Engineer's Authority and Responsibilities*

A. Neither Engineer's authority or responsibility under this Article 10 or under any other provision of the Contract, nor any decision made by Engineer in good faith either to exercise or not exercise such authority or responsibility or the undertaking, exercise, or performance of any authority or responsibility by Engineer, will create, impose, or give rise to any duty in contract, tort, or otherwise owed by Engineer to Contractor, any Subcontractor, any Supplier, any other individual or entity, or to any surety for or employee or agent of any of them.

B. Engineer will not supervise, direct, control, or have authority over or be responsible for Contractor's means, methods, techniques, sequences, or procedures of construction, or the safety precautions and programs incident thereto, or for any failure of Contractor to comply with Laws and Regulations applicable to the performance of the Work. Engineer will not be responsible for Contractor's failure to perform the Work in accordance with the Contract Documents.

C. Engineer will not be responsible for the acts or omissions of Contractor or of any Subcontractor, any Supplier, or of any other individual or entity performing any of the Work.

D. Engineer's review of the final Application for Payment and accompanying documentation, and all maintenance and operating instructions, schedules, guarantees, bonds, certificates of inspection, tests and approvals, and other documentation required to be delivered by Contractor under Paragraph 15.06.A, will only be to determine generally that their content complies with the requirements of, and in the case of certificates of inspections, tests, and approvals, that the results certified indicate compliance with the Contract Documents.

E. The limitations upon authority and responsibility set forth in this Paragraph 10.07 also apply to the Resident Project Representative, if any.

10.08 *Compliance with Safety Program*

A. While at the Site, Engineer's employees and representatives will comply with the specific applicable requirements of Owner's and Contractor's safety programs of which Engineer has been informed.

## ARTICLE 11—CHANGES TO THE CONTRACT

### 11.01 *Amending and Supplementing the Contract*

- A. The Contract may be amended or supplemented by a Change Order, a Work Change Directive, or a Field Order.
- B. If an amendment or supplement to the Contract includes a change in the Contract Price or the Contract Times, such amendment or supplement must be set forth in a Change Order.
- C. All changes to the Contract that involve (1) the performance or acceptability of the Work, (2) the design (as set forth in the Drawings, Specifications, or otherwise), or (3) other engineering or technical matters, must be supported by Engineer's recommendation. Owner and Contractor may amend other terms and conditions of the Contract without the recommendation of the Engineer.

### 11.02 *Change Orders*

- A. Owner and Contractor shall execute appropriate Change Orders covering:
  - 1. Changes in Contract Price or Contract Times which are agreed to by the parties, including any undisputed sum or amount of time for Work actually performed in accordance with a Work Change Directive;
  - 2. Changes in Contract Price resulting from an Owner set-off, unless Contractor has duly contested such set-off;
  - 3. Changes in the Work which are: (a) ordered by Owner pursuant to Paragraph 11.05, (b) required because of Owner's acceptance of defective Work under Paragraph 14.04 or Owner's correction of defective Work under Paragraph 14.07, or (c) agreed to by the parties, subject to the need for Engineer's recommendation if the change in the Work involves the design (as set forth in the Drawings, Specifications, or otherwise) or other engineering or technical matters; and
  - 4. Changes that embody the substance of any final and binding results under: Paragraph 11.03.B, resolving the impact of a Work Change Directive; Paragraph 11.09, concerning Change Proposals; Article 12, Claims; Paragraph 13.02.D, final adjustments resulting from allowances; Paragraph 13.03.D, final adjustments relating to determination of quantities for Unit Price Work; and similar provisions.
- B. If Owner or Contractor refuses to execute a Change Order that is required to be executed under the terms of Paragraph 11.02.A, it will be deemed to be of full force and effect, as if fully executed.

### 11.03 *Work Change Directives*

- A. A Work Change Directive will not change the Contract Price or the Contract Times but is evidence that the parties expect that the modification ordered or documented by a Work Change Directive will be incorporated in a subsequently issued Change Order, following negotiations by the parties as to the Work Change Directive's effect, if any, on the Contract Price and Contract Times; or, if negotiations are unsuccessful, by a determination under the terms of the Contract Documents governing adjustments, expressly including Paragraph 11.07 regarding change of Contract Price.



- B. If Owner has issued a Work Change Directive and:
  - 1. Contractor believes that an adjustment in Contract Times or Contract Price is necessary, then Contractor shall submit any Change Proposal seeking such an adjustment no later than 30 days after the completion of the Work set out in the Work Change Directive.
  - 2. Owner believes that an adjustment in Contract Times or Contract Price is necessary, then Owner shall submit any Claim seeking such an adjustment no later than 60 days after issuance of the Work Change Directive.

#### 11.04 *Field Orders*

- A. Engineer may authorize minor changes in the Work if the changes do not involve an adjustment in the Contract Price or the Contract Times and are compatible with the design concept of the completed Project as a functioning whole as indicated by the Contract Documents. Such changes will be accomplished by a Field Order and will be binding on Owner and also on Contractor, which shall perform the Work involved promptly.
- B. If Contractor believes that a Field Order justifies an adjustment in the Contract Price or Contract Times, then before proceeding with the Work at issue, Contractor shall submit a Change Proposal as provided herein.

#### 11.05 *Owner-Authorized Changes in the Work*

- A. Without invalidating the Contract and without notice to any surety, Owner may, at any time or from time to time, order additions, deletions, or revisions in the Work. Changes involving the design (as set forth in the Drawings, Specifications, or otherwise) or other engineering or technical matters will be supported by Engineer's recommendation.
- B. Such changes in the Work may be accomplished by a Change Order, if Owner and Contractor have agreed as to the effect, if any, of the changes on Contract Times or Contract Price; or by a Work Change Directive. Upon receipt of any such document, Contractor shall promptly proceed with the Work involved; or, in the case of a deletion in the Work, promptly cease construction activities with respect to such deleted Work. Added or revised Work must be performed under the applicable conditions of the Contract Documents.
- C. Nothing in this Paragraph 11.05 obligates Contractor to undertake work that Contractor reasonably concludes cannot be performed in a manner consistent with Contractor's safety obligations under the Contract Documents or Laws and Regulations.

#### 11.06 *Unauthorized Changes in the Work*

- A. Contractor shall not be entitled to an increase in the Contract Price or an extension of the Contract Times with respect to any work performed that is not required by the Contract Documents, as amended, modified, or supplemented, except in the case of an emergency as provided in Paragraph 7.15 or in the case of uncovering Work as provided in Paragraph 14.05.C.2.

#### 11.07 *Change of Contract Price*

- A. The Contract Price may only be changed by a Change Order. Any Change Proposal for an adjustment in the Contract Price must comply with the provisions of Paragraph 11.09. Any Claim for an adjustment of Contract Price must comply with the provisions of Article 12.
- B. An adjustment in the Contract Price will be determined as follows:

1. Where the Work involved is covered by unit prices contained in the Contract Documents, then by application of such unit prices to the quantities of the items involved (subject to the provisions of Paragraph 13.03);
  2. Where the Work involved is not covered by unit prices contained in the Contract Documents, then by a mutually agreed lump sum (which may include an allowance for overhead and profit not necessarily in accordance with Paragraph 11.07.C.2); or
  3. Where the Work involved is not covered by unit prices contained in the Contract Documents and the parties do not reach mutual agreement to a lump sum, then on the basis of the Cost of the Work (determined as provided in Paragraph 13.01) plus a Contractor's fee for overhead and profit (determined as provided in Paragraph 11.07.C).
- C. *Contractor's Fee:* When applicable, the Contractor's fee for overhead and profit will be determined as follows:
1. A mutually acceptable fixed fee; or
  2. If a fixed fee is not agreed upon, then a fee based on the following percentages of the various portions of the Cost of the Work:
    - a. For costs incurred under Paragraphs 13.01.B.1 and 13.01.B.2, the Contractor's fee will be 15 percent;
    - b. For costs incurred under Paragraph 13.01.B.3, the Contractor's fee will be 5 percent;
    - c. Where one or more tiers of subcontracts are on the basis of Cost of the Work plus a fee and no fixed fee is agreed upon, the intent of Paragraphs 11.07.C.2.a and 11.07.C.2.b is that the Contractor's fee will be based on: (1) a fee of 15 percent of the costs incurred under Paragraphs 13.01.B.1 and 13.01.B.2 by the Subcontractor that actually performs the Work, at whatever tier, and (2) with respect to Contractor itself and to any Subcontractors of a tier higher than that of the Subcontractor that actually performs the Work, a fee of 5 percent of the amount (fee plus underlying costs incurred) attributable to the next lower tier Subcontractor; provided, however, that for any such subcontracted Work the maximum total fee to be paid by Owner will be no greater than 27 percent of the costs incurred by the Subcontractor that actually performs the Work;
    - d. No fee will be payable on the basis of costs itemized under Paragraphs 13.01.B.4, 13.01.B.5, and 13.01.C;
    - e. The amount of credit to be allowed by Contractor to Owner for any change which results in a net decrease in Cost of the Work will be the amount of the actual net decrease in Cost of the Work and a deduction of an additional amount equal to 5 percent of such actual net decrease in Cost of the Work; and
    - f. When both additions and credits are involved in any one change or Change Proposal, the adjustment in Contractor's fee will be computed by determining the sum of the costs in each of the cost categories in Paragraph 13.01.B (specifically, payroll costs, Paragraph 13.01.B.1; incorporated materials and equipment costs, Paragraph 13.01.B.2; Subcontract costs, Paragraph 13.01.B.3; special consultants costs, Paragraph 13.01.B.4; and other costs, Paragraph 13.01.B.5) and applying to each such cost category sum the appropriate fee from Paragraphs 11.07.C.2.a through 11.07.C.2.e, inclusive.

#### 11.08 *Change of Contract Times*

- A. The Contract Times may only be changed by a Change Order. Any Change Proposal for an adjustment in the Contract Times must comply with the provisions of Paragraph 11.09. Any Claim for an adjustment in the Contract Times must comply with the provisions of Article 12.
- B. Delay, disruption, and interference in the Work, and any related changes in Contract Times, are addressed in and governed by Paragraph 4.05.

#### 11.09 *Change Proposals*

A. *Purpose and Content:* Contractor shall submit a Change Proposal to Engineer to request an adjustment in the Contract Times or Contract Price; contest an initial decision by Engineer concerning the requirements of the Contract Documents or relating to the acceptability of the Work under the Contract Documents; challenge a set-off against payment due; or seek other relief under the Contract. The Change Proposal will specify any proposed change in Contract Times or Contract Price, or other proposed relief, and explain the reason for the proposed change, with citations to any governing or applicable provisions of the Contract Documents. Each Change Proposal will address only one issue, or a set of closely related issues.

#### B. *Change Proposal Procedures*

1. *Submittal:* Contractor shall submit each Change Proposal to Engineer within 30 days after the start of the event giving rise thereto, or after such initial decision.
2. *Supporting Data:* The Contractor shall submit supporting data, including the proposed change in Contract Price or Contract Time (if any), to the Engineer and Owner within 15 days after the submittal of the Change Proposal.
  - a. Change Proposals based on or related to delay, interruption, or interference must comply with the provisions of Paragraphs 4.05.D and 4.05.E.
  - b. Change proposals related to a change of Contract Price must include full and detailed accounts of materials incorporated into the Work and labor and equipment used for the subject Work.

The supporting data must be accompanied by a written statement that the supporting data are accurate and complete, and that any requested time or price adjustment is the entire adjustment to which Contractor believes it is entitled as a result of said event.

3. *Engineer's Initial Review:* Engineer will advise Owner regarding the Change Proposal, and consider any comments or response from Owner regarding the Change Proposal. If in its discretion Engineer concludes that additional supporting data is needed before conducting a full review and making a decision regarding the Change Proposal, then Engineer may request that Contractor submit such additional supporting data by a date specified by Engineer, prior to Engineer beginning its full review of the Change Proposal.
4. *Engineer's Full Review and Action on the Change Proposal:* Upon receipt of Contractor's supporting data (including any additional data requested by Engineer), Engineer will conduct a full review of each Change Proposal and, within 30 days after such receipt of the Contractor's supporting data, either approve the Change Proposal in whole, deny it in whole, or approve it in part and deny it in part. Such actions must be in writing, with a copy provided to Owner and Contractor. If Engineer does not take action on the Change

Proposal within 30 days, then either Owner or Contractor may at any time thereafter submit a letter to the other party indicating that as a result of Engineer's inaction the Change Proposal is deemed denied, thereby commencing the time for appeal of the denial under Article 12.

5. *Binding Decision*: Engineer's decision is final and binding upon Owner and Contractor, unless Owner or Contractor appeals the decision by filing a Claim under Article 12.
- C. *Resolution of Certain Change Proposals*: If the Change Proposal does not involve the design (as set forth in the Drawings, Specifications, or otherwise), the acceptability of the Work, or other engineering or technical matters, then Engineer will notify the parties in writing that the Engineer is unable to resolve the Change Proposal. For purposes of further resolution of such a Change Proposal, such notice will be deemed a denial, and Contractor may choose to seek resolution under the terms of Article 12.
- D. *Post-Completion*: Contractor shall not submit any Change Proposals after Engineer issues a written recommendation of final payment pursuant to Paragraph 15.06.B.

#### 11.10 *Notification to Surety*

- A. If the provisions of any bond require notice to be given to a surety of any change affecting the general scope of the Work or the provisions of the Contract Documents (including, but not limited to, Contract Price or Contract Times), the giving of any such notice will be Contractor's responsibility. The amount of each applicable bond will be adjusted to reflect the effect of any such change.

### **ARTICLE 12—CLAIMS**

#### 12.01 *Claims*

- A. *Claims Process*: The following disputes between Owner and Contractor are subject to the Claims process set forth in this article:
  1. Appeals by Owner or Contractor of Engineer's decisions regarding Change Proposals;
  2. Owner demands for adjustments in the Contract Price or Contract Times, or other relief under the Contract Documents;
  3. Disputes that Engineer has been unable to address because they do not involve the design (as set forth in the Drawings, Specifications, or otherwise), the acceptability of the Work, or other engineering or technical matters; and
  4. Subject to the waiver provisions of Paragraph 15.07, any dispute arising after Engineer has issued a written recommendation of final payment pursuant to Paragraph 15.06.B.
- B. *Submittal of Claim*: The party submitting a Claim shall deliver it directly to the other party to the Contract promptly (but in no event later than 30 days) after the start of the event giving rise thereto; in the case of appeals regarding Change Proposals within 30 days of the decision under appeal. The party submitting the Claim shall also furnish a copy to the Engineer, for its information only. The responsibility to substantiate a Claim rests with the party making the Claim. In the case of a Claim by Contractor seeking an increase in the Contract Times or Contract Price, Contractor shall certify that the Claim is made in good faith, that the supporting data are accurate and complete, and that to the best of Contractor's knowledge

and belief the amount of time or money requested accurately reflects the full amount to which Contractor is entitled.

- C. *Review and Resolution*: The party receiving a Claim shall review it thoroughly, giving full consideration to its merits. The two parties shall seek to resolve the Claim through the exchange of information and direct negotiations. The parties may extend the time for resolving the Claim by mutual agreement. All actions taken on a Claim will be stated in writing and submitted to the other party, with a copy to Engineer.
- D. *Mediation*
  - 1. At any time after initiation of a Claim, Owner and Contractor may mutually agree to mediation of the underlying dispute. The agreement to mediate will stay the Claim submittal and response process.
  - 2. If Owner and Contractor agree to mediation, then after 60 days from such agreement, either Owner or Contractor may unilaterally terminate the mediation process, and the Claim submittal and decision process will resume as of the date of the termination. If the mediation proceeds but is unsuccessful in resolving the dispute, the Claim submittal and decision process will resume as of the date of the conclusion of the mediation, as determined by the mediator.
  - 3. Owner and Contractor shall each pay one-half of the mediator's fees and costs.
- E. *Partial Approval*: If the party receiving a Claim approves the Claim in part and denies it in part, such action will be final and binding unless within 30 days of such action the other party invokes the procedure set forth in Article 17 for final resolution of disputes.
- F. *Denial of Claim*: If efforts to resolve a Claim are not successful, the party receiving the Claim may deny it by giving written notice of denial to the other party. If the receiving party does not take action on the Claim within 90 days, then either Owner or Contractor may at any time thereafter submit a letter to the other party indicating that as a result of the inaction, the Claim is deemed denied, thereby commencing the time for appeal of the denial. A denial of the Claim will be final and binding unless within 30 days of the denial the other party invokes the procedure set forth in Article 17 for the final resolution of disputes.
- G. *Final and Binding Results*: If the parties reach a mutual agreement regarding a Claim, whether through approval of the Claim, direct negotiations, mediation, or otherwise; or if a Claim is approved in part and denied in part, or denied in full, and such actions become final and binding; then the results of the agreement or action on the Claim will be incorporated in a Change Order or other written document to the extent they affect the Contract, including the Work, the Contract Times, or the Contract Price.

## **ARTICLE 13—COST OF THE WORK; ALLOWANCES; UNIT PRICE WORK**

### **13.01 *Cost of the Work***

- A. *Purposes for Determination of Cost of the Work*: The term Cost of the Work means the sum of all costs necessary for the proper performance of the Work at issue, as further defined below. The provisions of this Paragraph 13.01 are used for two distinct purposes:
  - 1. To determine Cost of the Work when Cost of the Work is a component of the Contract Price, under cost-plus-fee, time-and-materials, or other cost-based terms; or

2. When needed to determine the value of a Change Order, Change Proposal, Claim, set-off, or other adjustment in Contract Price. When the value of any such adjustment is determined on the basis of Cost of the Work, Contractor is entitled only to those additional or incremental costs required because of the change in the Work or because of the event giving rise to the adjustment.
- B. *Costs Included:* Except as otherwise may be agreed to in writing by Owner, costs included in the Cost of the Work will be in amounts no higher than those commonly incurred in the locality of the Project, will not include any of the costs itemized in Paragraph 13.01.C, and will include only the following items:
1. Payroll costs for employees in the direct employ of Contractor in the performance of the Work under schedules of job classifications agreed upon by Owner and Contractor in advance of the subject Work. Such employees include, without limitation, superintendents, foremen, safety managers, safety representatives, and other personnel employed full time on the Work. Payroll costs for employees not employed full time on the Work will be apportioned on the basis of their time spent on the Work. Payroll costs include, but are not limited to, salaries and wages plus the cost of fringe benefits, which include social security contributions, unemployment, excise, and payroll taxes, workers' compensation, health and retirement benefits, sick leave, and vacation and holiday pay applicable thereto. The expenses of performing Work outside of regular working hours, on Saturday, Sunday, or legal holidays, will be included in the above to the extent authorized by Owner.
  2. Cost of all materials and equipment furnished and incorporated in the Work, including costs of transportation and storage thereof, and Suppliers' field services required in connection therewith. All cash discounts accrue to Contractor unless Owner deposits funds with Contractor with which to make payments, in which case the cash discounts will accrue to Owner. All trade discounts, rebates, and refunds and returns from sale of surplus materials and equipment will accrue to Owner, and Contractor shall make provisions so that they may be obtained.
  3. Payments made by Contractor to Subcontractors for Work performed by Subcontractors. If required by Owner, Contractor shall obtain competitive bids from subcontractors acceptable to Owner and Contractor and shall deliver such bids to Owner, which will then determine, with the advice of Engineer, which bids, if any, will be acceptable. If any subcontract provides that the Subcontractor is to be paid on the basis of Cost of the Work plus a fee, the Subcontractor's Cost of the Work and fee will be determined in the same manner as Contractor's Cost of the Work and fee as provided in this Paragraph 13.01.
  4. Costs of special consultants (including but not limited to engineers, architects, testing laboratories, surveyors, attorneys, and accountants) employed or retained for services specifically related to the Work.
  5. Other costs consisting of the following:
    - a. The proportion of necessary transportation, travel, and subsistence expenses of Contractor's employees incurred in discharge of duties connected with the Work.
    - b. Cost, including transportation and maintenance, of all materials, supplies, equipment, machinery, appliances, office, and temporary facilities at the Site, which are

consumed in the performance of the Work, and cost, less market value, of such items used but not consumed which remain the property of Contractor.

- 1) In establishing included costs for materials such as scaffolding, plating, or sheeting, consideration will be given to the actual or the estimated life of the material for use on other projects; or rental rates may be established on the basis of purchase or salvage value of such items, whichever is less. Contractor will not be eligible for compensation for such items in an amount that exceeds the purchase cost of such item.

c. *Construction Equipment Rental*

- 1) Rentals of all construction equipment and machinery, and the parts thereof, in accordance with rental agreements approved by Owner as to price (including any surcharge or special rates applicable to overtime use of the construction equipment or machinery), and the costs of transportation, loading, unloading, assembly, dismantling, and removal thereof. All such costs will be in accordance with the terms of said rental agreements. The rental of any such equipment, machinery, or parts must cease when the use thereof is no longer necessary for the Work.
- 2) Costs for equipment and machinery owned by Contractor or a Contractor-related entity will be paid at a rate shown for such equipment in the equipment rental rate book specified in the Supplementary Conditions. An hourly rate will be computed by dividing the monthly rates by 176. These computed rates will include all operating costs.
- 3) With respect to Work that is the result of a Change Order, Change Proposal, Claim, set-off, or other adjustment in Contract Price ("changed Work"), included costs will be based on the time the equipment or machinery is in use on the changed Work and the costs of transportation, loading, unloading, assembly, dismantling, and removal when directly attributable to the changed Work. The cost of any such equipment or machinery, or parts thereof, must cease to accrue when the use thereof is no longer necessary for the changed Work.

- d. Sales, consumer, use, and other similar taxes related to the Work, and for which Contractor is liable, as imposed by Laws and Regulations.
- e. Deposits lost for causes other than negligence of Contractor, any Subcontractor, or anyone directly or indirectly employed by any of them or for whose acts any of them may be liable, and royalty payments and fees for permits and licenses.
- f. Losses and damages (and related expenses) caused by damage to the Work, not compensated by insurance or otherwise, sustained by Contractor in connection with the performance of the Work (except losses and damages within the deductible amounts of builder's risk or other property insurance established in accordance with Paragraph 6.04), provided such losses and damages have resulted from causes other than the negligence of Contractor, any Subcontractor, or anyone directly or indirectly employed by any of them or for whose acts any of them may be liable. Such losses include settlements made with the written consent and approval of Owner. No such losses, damages, and expenses will be included in the Cost of the Work for the purpose of determining Contractor's fee.

- g. The cost of utilities, fuel, and sanitary facilities at the Site.
- h. Minor expenses such as communication service at the Site, express and courier services, and similar petty cash items in connection with the Work.
- i. The costs of premiums for all bonds and insurance that Contractor is required by the Contract Documents to purchase and maintain.

C. *Costs Excluded*: The term Cost of the Work does not include any of the following items:

- 1. Payroll costs and other compensation of Contractor's officers, executives, principals, general managers, engineers, architects, estimators, attorneys, auditors, accountants, purchasing and contracting agents, expeditors, timekeepers, clerks, and other personnel employed by Contractor, whether at the Site or in Contractor's principal or branch office for general administration of the Work and not specifically included in the agreed upon schedule of job classifications referred to in Paragraph 13.01.B.1 or specifically covered by Paragraph 13.01.B.4. The payroll costs and other compensation excluded here are to be considered administrative costs covered by the Contractor's fee.
- 2. The cost of purchasing, renting, or furnishing small tools and hand tools.
- 3. Expenses of Contractor's principal and branch offices other than Contractor's office at the Site.
- 4. Any part of Contractor's capital expenses, including interest on Contractor's capital employed for the Work and charges against Contractor for delinquent payments.
- 5. Costs due to the negligence of Contractor, any Subcontractor, or anyone directly or indirectly employed by any of them or for whose acts any of them may be liable, including but not limited to, the correction of defective Work, disposal of materials or equipment wrongly supplied, and making good any damage to property.
- 6. Expenses incurred in preparing and advancing Claims.
- 7. Other overhead or general expense costs of any kind and the costs of any item not specifically and expressly included in Paragraph 13.01.B.

D. *Contractor's Fee*

- 1. When the Work as a whole is performed on the basis of cost-plus-a-fee, then:
  - a. Contractor's fee for the Work set forth in the Contract Documents as of the Effective Date of the Contract will be determined as set forth in the Agreement.
  - b. for any Work covered by a Change Order, Change Proposal, Claim, set-off, or other adjustment in Contract Price on the basis of Cost of the Work, Contractor's fee will be determined as follows:
    - 1) When the fee for the Work as a whole is a percentage of the Cost of the Work, the fee will automatically adjust as the Cost of the Work changes.
    - 2) When the fee for the Work as a whole is a fixed fee, the fee for any additions or deletions will be determined in accordance with Paragraph 11.07.C.2.
- 2. When the Work as a whole is performed on the basis of a stipulated sum, or any other basis other than cost-plus-a-fee, then Contractor's fee for any Work covered by a Change



Order, Change Proposal, Claim, set-off, or other adjustment in Contract Price on the basis of Cost of the Work will be determined in accordance with Paragraph 11.07.C.2.

- E. *Documentation and Audit*: Whenever the Cost of the Work for any purpose is to be determined pursuant to this Article 13, Contractor and pertinent Subcontractors will establish and maintain records of the costs in accordance with generally accepted accounting practices. Subject to prior written notice, Owner will be afforded reasonable access, during normal business hours, to all Contractor's accounts, records, books, correspondence, instructions, drawings, receipts, vouchers, memoranda, and similar data relating to the Cost of the Work and Contractor's fee. Contractor shall preserve all such documents for a period of three years after the final payment by Owner. Pertinent Subcontractors will afford such access to Owner, and preserve such documents, to the same extent required of Contractor.

### 13.02 Allowances

- A. It is understood that Contractor has included in the Contract Price all allowances so named in the Contract Documents and shall cause the Work so covered to be performed for such sums and by such persons or entities as may be acceptable to Owner and Engineer.
- B. *Cash Allowances*: Contractor agrees that:
1. the cash allowances include the cost to Contractor (less any applicable trade discounts) of materials and equipment required by the allowances to be delivered at the Site, and all applicable taxes; and
  2. Contractor's costs for unloading and handling on the Site, labor, installation, overhead, profit, and other expenses contemplated for the cash allowances have been included in the Contract Price and not in the allowances, and no demand for additional payment for any of the foregoing will be valid.
- C. *Owner's Contingency Allowance*: Contractor agrees that an Owner's contingency allowance, if any, is for the sole use of Owner to cover unanticipated costs.
- D. Prior to final payment, an appropriate Change Order will be issued as recommended by Engineer to reflect actual amounts due Contractor for Work covered by allowances, and the Contract Price will be correspondingly adjusted.

### 13.03 Unit Price Work

- A. Where the Contract Documents provide that all or part of the Work is to be Unit Price Work, initially the Contract Price will be deemed to include for all Unit Price Work an amount equal to the sum of the unit price for each separately identified item of Unit Price Work times the estimated quantity of each item as indicated in the Agreement.
- B. The estimated quantities of items of Unit Price Work are not guaranteed and are solely for the purpose of comparison of Bids and determining an initial Contract Price. Payments to Contractor for Unit Price Work will be based on actual quantities.
- C. Each unit price will be deemed to include an amount considered by Contractor to be adequate to cover Contractor's overhead and profit for each separately identified item.
- D. Engineer will determine the actual quantities and classifications of Unit Price Work performed by Contractor. Engineer will review with Contractor the Engineer's preliminary determinations on such matters before rendering a written decision thereon (by recommendation of an Application for Payment or otherwise). Engineer's written decision

thereon will be final and binding (except as modified by Engineer to reflect changed factual conditions or more accurate data) upon Owner and Contractor, and the final adjustment of Contract Price will be set forth in a Change Order, subject to the provisions of the following paragraph.

E. *Adjustments in Unit Price*

1. Contractor or Owner shall be entitled to an adjustment in the unit price with respect to an item of Unit Price Work if:
  - a. the quantity of the item of Unit Price Work performed by Contractor differs materially and significantly from the estimated quantity of such item indicated in the Agreement; and
  - b. Contractor's unit costs to perform the item of Unit Price Work have changed materially and significantly as a result of the quantity change.
2. The adjustment in unit price will account for and be coordinated with any related changes in quantities of other items of Work, and in Contractor's costs to perform such other Work, such that the resulting overall change in Contract Price is equitable to Owner and Contractor.
3. Adjusted unit prices will apply to all units of that item.

**ARTICLE 14—TESTS AND INSPECTIONS; CORRECTION, REMOVAL, OR ACCEPTANCE OF DEFECTIVE WORK**

14.01 *Access to Work*

- A. Owner, Engineer, their consultants and other representatives and personnel of Owner, independent testing laboratories, and authorities having jurisdiction have access to the Site and the Work at reasonable times for their observation, inspection, and testing. Contractor shall provide them proper and safe conditions for such access and advise them of Contractor's safety procedures and programs so that they may comply with such procedures and programs as applicable.

14.02 *Tests, Inspections, and Approvals*

- A. Contractor shall give Engineer timely notice of readiness of the Work (or specific parts thereof) for all required inspections and tests, and shall cooperate with inspection and testing personnel to facilitate required inspections and tests.
- B. Owner shall retain and pay for the services of an independent inspector, testing laboratory, or other qualified individual or entity to perform all inspections and tests expressly required by the Contract Documents to be furnished and paid for by Owner, except that costs incurred in connection with tests or inspections of covered Work will be governed by the provisions of Paragraph 14.05.
- C. If Laws or Regulations of any public body having jurisdiction require any Work (or part thereof) specifically to be inspected, tested, or approved by an employee or other representative of such public body, Contractor shall assume full responsibility for arranging and obtaining such inspections, tests, or approvals, pay all costs in connection therewith, and furnish Engineer the required certificates of inspection or approval.

- D. Contractor shall be responsible for arranging, obtaining, and paying for all inspections and tests required:
1. by the Contract Documents, unless the Contract Documents expressly allocate responsibility for a specific inspection or test to Owner;
  2. to attain Owner's and Engineer's acceptance of materials or equipment to be incorporated in the Work;
  3. by manufacturers of equipment furnished under the Contract Documents;
  4. for testing, adjusting, and balancing of mechanical, electrical, and other equipment to be incorporated into the Work; and
  5. for acceptance of materials, mix designs, or equipment submitted for approval prior to Contractor's purchase thereof for incorporation in the Work.

Such inspections and tests will be performed by independent inspectors, testing laboratories, or other qualified individuals or entities acceptable to Owner and Engineer.

- E. If the Contract Documents require the Work (or part thereof) to be approved by Owner, Engineer, or another designated individual or entity, then Contractor shall assume full responsibility for arranging and obtaining such approvals.
- F. If any Work (or the work of others) that is to be inspected, tested, or approved is covered by Contractor without written concurrence of Engineer, Contractor shall, if requested by Engineer, uncover such Work for observation. Such uncovering will be at Contractor's expense unless Contractor had given Engineer timely notice of Contractor's intention to cover the same and Engineer had not acted with reasonable promptness in response to such notice.

#### 14.03 *Defective Work*

- A. *Contractor's Obligation:* It is Contractor's obligation to assure that the Work is not defective.
- B. *Engineer's Authority:* Engineer has the authority to determine whether Work is defective, and to reject defective Work.
- C. *Notice of Defects:* Prompt written notice of all defective Work of which Owner or Engineer has actual knowledge will be given to Contractor.
- D. *Correction, or Removal and Replacement:* Promptly after receipt of written notice of defective Work, Contractor shall correct all such defective Work, whether or not fabricated, installed, or completed, or, if Engineer has rejected the defective Work, remove it from the Project and replace it with Work that is not defective.
- E. *Preservation of Warranties:* When correcting defective Work, Contractor shall take no action that would void or otherwise impair Owner's special warranty and guarantee, if any, on said Work.
- F. *Costs and Damages:* In addition to its correction, removal, and replacement obligations with respect to defective Work, Contractor shall pay all claims, costs, losses, and damages arising out of or relating to defective Work, including but not limited to the cost of the inspection, testing, correction, removal, replacement, or reconstruction of such defective Work, fines levied against Owner by governmental authorities because the Work is defective, and the costs of repair or replacement of work of others resulting from defective Work. Prior to final payment, if Owner and Contractor are unable to agree as to the measure of such claims, costs,

losses, and damages resulting from defective Work, then Owner may impose a reasonable set-off against payments due under Article 15.

#### 14.04 *Acceptance of Defective Work*

- A. If, instead of requiring correction or removal and replacement of defective Work, Owner prefers to accept it, Owner may do so (subject, if such acceptance occurs prior to final payment, to Engineer's confirmation that such acceptance is in general accord with the design intent and applicable engineering principles, and will not endanger public safety). Contractor shall pay all claims, costs, losses, and damages attributable to Owner's evaluation of and determination to accept such defective Work (such costs to be approved by Engineer as to reasonableness), and for the diminished value of the Work to the extent not otherwise paid by Contractor. If any such acceptance occurs prior to final payment, the necessary revisions in the Contract Documents with respect to the Work will be incorporated in a Change Order. If the parties are unable to agree as to the decrease in the Contract Price, reflecting the diminished value of Work so accepted, then Owner may impose a reasonable set-off against payments due under Article 15. If the acceptance of defective Work occurs after final payment, Contractor shall pay an appropriate amount to Owner.

#### 14.05 *Uncovering Work*

- A. Engineer has the authority to require additional inspection or testing of the Work, whether or not the Work is fabricated, installed, or completed.
- B. If any Work is covered contrary to the written request of Engineer, then Contractor shall, if requested by Engineer, uncover such Work for Engineer's observation, and then replace the covering, all at Contractor's expense.
- C. If Engineer considers it necessary or advisable that covered Work be observed by Engineer or inspected or tested by others, then Contractor, at Engineer's request, shall uncover, expose, or otherwise make available for observation, inspection, or testing as Engineer may require, that portion of the Work in question, and provide all necessary labor, material, and equipment.
  1. If it is found that the uncovered Work is defective, Contractor shall be responsible for all claims, costs, losses, and damages arising out of or relating to such uncovering, exposure, observation, inspection, and testing, and of satisfactory replacement or reconstruction (including but not limited to all costs of repair or replacement of work of others); and pending Contractor's full discharge of this responsibility the Owner shall be entitled to impose a reasonable set-off against payments due under Article 15.
  2. If the uncovered Work is not found to be defective, Contractor shall be allowed an increase in the Contract Price or an extension of the Contract Times, directly attributable to such uncovering, exposure, observation, inspection, testing, replacement, and reconstruction. If the parties are unable to agree as to the amount or extent thereof, then Contractor may submit a Change Proposal within 30 days of the determination that the Work is not defective.

#### 14.06 *Owner May Stop the Work*

- A. If the Work is defective, or Contractor fails to supply sufficient skilled workers or suitable materials or equipment, or fails to perform the Work in such a way that the completed Work will conform to the Contract Documents, then Owner may order Contractor to stop the Work,

or any portion thereof, until the cause for such order has been eliminated; however, this right of Owner to stop the Work will not give rise to any duty on the part of Owner to exercise this right for the benefit of Contractor, any Subcontractor, any Supplier, any other individual or entity, or any surety for, or employee or agent of any of them.

**14.07 Owner May Correct Defective Work**

- A. If Contractor fails within a reasonable time after written notice from Engineer to correct defective Work, or to remove and replace defective Work as required by Engineer, then Owner may, after 7 days' written notice to Contractor, correct or remedy any such deficiency.
- B. In exercising the rights and remedies under this Paragraph 14.07, Owner shall proceed expeditiously. In connection with such corrective or remedial action, Owner may exclude Contractor from all or part of the Site, take possession of all or part of the Work and suspend Contractor's services related thereto, and incorporate in the Work all materials and equipment stored at the Site or for which Owner has paid Contractor but which are stored elsewhere. Contractor shall allow Owner, Owner's representatives, agents and employees, Owner's other contractors, and Engineer and Engineer's consultants access to the Site to enable Owner to exercise the rights and remedies under this paragraph.
- C. All claims, costs, losses, and damages incurred or sustained by Owner in exercising the rights and remedies under this Paragraph 14.07 will be charged against Contractor as set-offs against payments due under Article 15. Such claims, costs, losses and damages will include but not be limited to all costs of repair, or replacement of work of others destroyed or damaged by correction, removal, or replacement of Contractor's defective Work.
- D. Contractor shall not be allowed an extension of the Contract Times because of any delay in the performance of the Work attributable to the exercise by Owner of Owner's rights and remedies under this Paragraph 14.07.

**ARTICLE 15—PAYMENTS TO CONTRACTOR; SET-OFFS; COMPLETION; CORRECTION PERIOD**

**15.01 Progress Payments**

- A. *Basis for Progress Payments:* The Schedule of Values established as provided in Article 2 will serve as the basis for progress payments and will be incorporated into a form of Application for Payment acceptable to Engineer. Progress payments for Unit Price Work will be based on the number of units completed during the pay period, as determined under the provisions of Paragraph 13.03. Progress payments for cost-based Work will be based on Cost of the Work completed by Contractor during the pay period.
- B. *Applications for Payments*
  - 1. At least 20 days before the date established in the Agreement for each progress payment (but not more often than once a month), Contractor shall submit to Engineer for review an Application for Payment filled out and signed by Contractor covering the Work completed as of the date of the Application and accompanied by such supporting documentation as is required by the Contract Documents.
  - 2. If payment is requested on the basis of materials and equipment not incorporated in the Work but delivered and suitably stored at the Site or at another location agreed to in writing, the Application for Payment must also be accompanied by: (a) a bill of sale, invoice, copies of subcontract or purchase order payments, or other documentation

establishing full payment by Contractor for the materials and equipment; (b) at Owner's request, documentation warranting that Owner has received the materials and equipment free and clear of all Liens; and (c) evidence that the materials and equipment are covered by appropriate property insurance, a warehouse bond, or other arrangements to protect Owner's interest therein, all of which must be satisfactory to Owner.

3. Beginning with the second Application for Payment, each Application must include an affidavit of Contractor stating that all previous progress payments received by Contractor have been applied to discharge Contractor's legitimate obligations associated with prior Applications for Payment.
4. The amount of retainage with respect to progress payments will be as stipulated in the Agreement.

C. *Review of Applications*

1. Engineer will, within 10 days after receipt of each Application for Payment, including each resubmittal, either indicate in writing a recommendation of payment and present the Application to Owner, or return the Application to Contractor indicating in writing Engineer's reasons for refusing to recommend payment. In the latter case, Contractor may make the necessary corrections and resubmit the Application.
2. Engineer's recommendation of any payment requested in an Application for Payment will constitute a representation by Engineer to Owner, based on Engineer's observations of the executed Work as an experienced and qualified design professional, and on Engineer's review of the Application for Payment and the accompanying data and schedules, that to the best of Engineer's knowledge, information and belief:
  - a. the Work has progressed to the point indicated;
  - b. the quality of the Work is generally in accordance with the Contract Documents (subject to an evaluation of the Work as a functioning whole prior to or upon Substantial Completion, the results of any subsequent tests called for in the Contract Documents, a final determination of quantities and classifications for Unit Price Work under Paragraph 13.03, and any other qualifications stated in the recommendation); and
  - c. the conditions precedent to Contractor's being entitled to such payment appear to have been fulfilled in so far as it is Engineer's responsibility to observe the Work.
3. By recommending any such payment Engineer will not thereby be deemed to have represented that:
  - a. inspections made to check the quality or the quantity of the Work as it has been performed have been exhaustive, extended to every aspect of the Work in progress, or involved detailed inspections of the Work beyond the responsibilities specifically assigned to Engineer in the Contract; or
  - b. there may not be other matters or issues between the parties that might entitle Contractor to be paid additionally by Owner or entitle Owner to withhold payment to Contractor.

4. Neither Engineer's review of Contractor's Work for the purposes of recommending payments nor Engineer's recommendation of any payment, including final payment, will impose responsibility on Engineer:
  - a. to supervise, direct, or control the Work;
  - b. for the means, methods, techniques, sequences, or procedures of construction, or the safety precautions and programs incident thereto;
  - c. for Contractor's failure to comply with Laws and Regulations applicable to Contractor's performance of the Work;
  - d. to make any examination to ascertain how or for what purposes Contractor has used the money paid by Owner; or
  - e. to determine that title to any of the Work, materials, or equipment has passed to Owner free and clear of any Liens.
5. Engineer may refuse to recommend the whole or any part of any payment if, in Engineer's opinion, it would be incorrect to make the representations to Owner stated in Paragraph 15.01.C.2.
6. Engineer will recommend reductions in payment (set-offs) necessary in Engineer's opinion to protect Owner from loss because:
  - a. the Work is defective, requiring correction or replacement;
  - b. the Contract Price has been reduced by Change Orders;
  - c. Owner has been required to correct defective Work in accordance with Paragraph 14.07, or has accepted defective Work pursuant to Paragraph 14.04;
  - d. Owner has been required to remove or remediate a Hazardous Environmental Condition for which Contractor is responsible; or
  - e. Engineer has actual knowledge of the occurrence of any of the events that would constitute a default by Contractor and therefore justify termination for cause under the Contract Documents.

**D. *Payment Becomes Due***

1. Ten days after presentation of the Application for Payment to Owner with Engineer's recommendation, the amount recommended (subject to any Owner set-offs) will become due, and when due will be paid by Owner to Contractor.

**E. *Reductions in Payment by Owner***

1. In addition to any reductions in payment (set-offs) recommended by Engineer, Owner is entitled to impose a set-off against payment based on any of the following:
  - a. Claims have been made against Owner based on Contractor's conduct in the performance or furnishing of the Work, or Owner has incurred costs, losses, or damages resulting from Contractor's conduct in the performance or furnishing of the Work, including but not limited to claims, costs, losses, or damages from workplace injuries, adjacent property damage, non-compliance with Laws and Regulations, and patent infringement;

- b. Contractor has failed to take reasonable and customary measures to avoid damage, delay, disruption, and interference with other work at or adjacent to the Site;
  - c. Contractor has failed to provide and maintain required bonds or insurance;
  - d. Owner has been required to remove or remediate a Hazardous Environmental Condition for which Contractor is responsible;
  - e. Owner has incurred extra charges or engineering costs related to submittal reviews, evaluations of proposed substitutes, tests and inspections, or return visits to manufacturing or assembly facilities;
  - f. The Work is defective, requiring correction or replacement;
  - g. Owner has been required to correct defective Work in accordance with Paragraph 14.07, or has accepted defective Work pursuant to Paragraph 14.04;
  - h. The Contract Price has been reduced by Change Orders;
  - i. An event has occurred that would constitute a default by Contractor and therefore justify a termination for cause;
  - j. Liquidated or other damages have accrued as a result of Contractor's failure to achieve Milestones, Substantial Completion, or final completion of the Work;
  - k. Liens have been filed in connection with the Work, except where Contractor has delivered a specific bond satisfactory to Owner to secure the satisfaction and discharge of such Liens; or
  - l. Other items entitle Owner to a set-off against the amount recommended.
2. If Owner imposes any set-off against payment, whether based on its own knowledge or on the written recommendations of Engineer, Owner will give Contractor immediate written notice (with a copy to Engineer) stating the reasons for such action and the specific amount of the reduction, and promptly pay Contractor any amount remaining after deduction of the amount so withheld. Owner shall promptly pay Contractor the amount so withheld, or any adjustment thereto agreed to by Owner and Contractor, if Contractor remedies the reasons for such action. The reduction imposed will be binding on Contractor unless it duly submits a Change Proposal contesting the reduction.
  3. Upon a subsequent determination that Owner's refusal of payment was not justified, the amount wrongfully withheld will be treated as an amount due as determined by Paragraph 15.01.D.1 and subject to interest as provided in the Agreement.

15.02 *Contractor's Warranty of Title*

- A. Contractor warrants and guarantees that title to all Work, materials, and equipment furnished under the Contract will pass to Owner free and clear of (1) all Liens and other title defects, and (2) all patent, licensing, copyright, or royalty obligations, no later than 7 days after the time of payment by Owner.

15.03 *Substantial Completion*

- A. When Contractor considers the entire Work ready for its intended use Contractor shall notify Owner and Engineer in writing that the entire Work is substantially complete and request that Engineer issue a certificate of Substantial Completion. Contractor shall at the same time



submit to Owner and Engineer an initial draft of punch list items to be completed or corrected before final payment.

- B. Promptly after Contractor's notification, Owner, Contractor, and Engineer shall make an inspection of the Work to determine the status of completion. If Engineer does not consider the Work substantially complete, Engineer will notify Contractor in writing giving the reasons therefor.
- C. If Engineer considers the Work substantially complete, Engineer will deliver to Owner a preliminary certificate of Substantial Completion which will fix the date of Substantial Completion. Engineer shall attach to the certificate a punch list of items to be completed or corrected before final payment. Owner shall have 7 days after receipt of the preliminary certificate during which to make written objection to Engineer as to any provisions of the certificate or attached punch list. If, after considering the objections to the provisions of the preliminary certificate, Engineer concludes that the Work is not substantially complete, Engineer will, within 14 days after submission of the preliminary certificate to Owner, notify Contractor in writing that the Work is not substantially complete, stating the reasons therefor. If Owner does not object to the provisions of the certificate, or if despite consideration of Owner's objections Engineer concludes that the Work is substantially complete, then Engineer will, within said 14 days, execute and deliver to Owner and Contractor a final certificate of Substantial Completion (with a revised punch list of items to be completed or corrected) reflecting such changes from the preliminary certificate as Engineer believes justified after consideration of any objections from Owner.
- D. At the time of receipt of the preliminary certificate of Substantial Completion, Owner and Contractor will confer regarding Owner's use or occupancy of the Work following Substantial Completion, review the builder's risk insurance policy with respect to the end of the builder's risk coverage, and confirm the transition to coverage of the Work under a permanent property insurance policy held by Owner. Unless Owner and Contractor agree otherwise in writing, Owner shall bear responsibility for security, operation, protection of the Work, property insurance, maintenance, heat, and utilities upon Owner's use or occupancy of the Work.
- E. After Substantial Completion the Contractor shall promptly begin work on the punch list of items to be completed or corrected prior to final payment. In appropriate cases Contractor may submit monthly Applications for Payment for completed punch list items, following the progress payment procedures set forth above.
- F. Owner shall have the right to exclude Contractor from the Site after the date of Substantial Completion subject to allowing Contractor reasonable access to remove its property and complete or correct items on the punch list.

#### 15.04 *Partial Use or Occupancy*

- A. Prior to Substantial Completion of all the Work, Owner may use or occupy any substantially completed part of the Work which has specifically been identified in the Contract Documents, or which Owner, Engineer, and Contractor agree constitutes a separately functioning and usable part of the Work that can be used by Owner for its intended purpose without

significant interference with Contractor's performance of the remainder of the Work, subject to the following conditions:

1. At any time, Owner may request in writing that Contractor permit Owner to use or occupy any such part of the Work that Owner believes to be substantially complete. If and when Contractor agrees that such part of the Work is substantially complete, Contractor, Owner, and Engineer will follow the procedures of Paragraph 15.03.A through 15.03.E for that part of the Work.
2. At any time, Contractor may notify Owner and Engineer in writing that Contractor considers any such part of the Work substantially complete and request Engineer to issue a certificate of Substantial Completion for that part of the Work.
3. Within a reasonable time after either such request, Owner, Contractor, and Engineer shall make an inspection of that part of the Work to determine its status of completion. If Engineer does not consider that part of the Work to be substantially complete, Engineer will notify Owner and Contractor in writing giving the reasons therefor. If Engineer considers that part of the Work to be substantially complete, the provisions of Paragraph 15.03 will apply with respect to certification of Substantial Completion of that part of the Work and the division of responsibility in respect thereof and access thereto.
4. No use or occupancy or separate operation of part of the Work may occur prior to compliance with the requirements of Paragraph 6.04 regarding builder's risk or other property insurance.

#### 15.05 *Final Inspection*

- A. Upon written notice from Contractor that the entire Work or an agreed portion thereof is complete, Engineer will promptly make a final inspection with Owner and Contractor and will notify Contractor in writing of all particulars in which this inspection reveals that the Work, or agreed portion thereof, is incomplete or defective. Contractor shall immediately take such measures as are necessary to complete such Work or remedy such deficiencies.

#### 15.06 *Final Payment*

##### A. *Application for Payment*

1. After Contractor has, in the opinion of Engineer, satisfactorily completed all corrections identified during the final inspection and has delivered, in accordance with the Contract Documents, all maintenance and operating instructions, schedules, guarantees, bonds, certificates or other evidence of insurance, certificates of inspection, annotated record documents (as provided in Paragraph 7.12), and other documents, Contractor may make application for final payment.
2. The final Application for Payment must be accompanied (except as previously delivered) by:
  - a. all documentation called for in the Contract Documents;
  - b. consent of the surety, if any, to final payment;
  - c. satisfactory evidence that all title issues have been resolved such that title to all Work, materials, and equipment has passed to Owner free and clear of any Liens or other title defects, or will so pass upon final payment.

- d. a list of all duly pending Change Proposals and Claims; and
  - e. complete and legally effective releases or waivers (satisfactory to Owner) of all Lien rights arising out of the Work, and of Liens filed in connection with the Work.
3. In lieu of the releases or waivers of Liens specified in Paragraph 15.06.A.2 and as approved by Owner, Contractor may furnish receipts or releases in full and an affidavit of Contractor that: (a) the releases and receipts include all labor, services, material, and equipment for which a Lien could be filed; and (b) all payrolls, material and equipment bills, and other indebtedness connected with the Work for which Owner might in any way be responsible, or which might in any way result in liens or other burdens on Owner's property, have been paid or otherwise satisfied. If any Subcontractor or Supplier fails to furnish such a release or receipt in full, Contractor may furnish a bond or other collateral satisfactory to Owner to indemnify Owner against any Lien, or Owner at its option may issue joint checks payable to Contractor and specified Subcontractors and Suppliers.
- B. *Engineer's Review of Final Application and Recommendation of Payment:* If, on the basis of Engineer's observation of the Work during construction and final inspection, and Engineer's review of the final Application for Payment and accompanying documentation as required by the Contract Documents, Engineer is satisfied that the Work has been completed and Contractor's other obligations under the Contract have been fulfilled, Engineer will, within 10 days after receipt of the final Application for Payment, indicate in writing Engineer's recommendation of final payment and present the final Application for Payment to Owner for payment. Such recommendation will account for any set-offs against payment that are necessary in Engineer's opinion to protect Owner from loss for the reasons stated above with respect to progress payments. Otherwise, Engineer will return the Application for Payment to Contractor, indicating in writing the reasons for refusing to recommend final payment, in which case Contractor shall make the necessary corrections and resubmit the Application for Payment.
- C. *Notice of Acceptability:* In support of its recommendation of payment of the final Application for Payment, Engineer will also give written notice to Owner and Contractor that the Work is acceptable, subject to stated limitations in the notice and to the provisions of Paragraph 15.07.
- D. *Completion of Work:* The Work is complete (subject to surviving obligations) when it is ready for final payment as established by the Engineer's written recommendation of final payment and issuance of notice of the acceptability of the Work.
- E. *Final Payment Becomes Due:* Upon receipt from Engineer of the final Application for Payment and accompanying documentation, Owner shall set off against the amount recommended by Engineer for final payment any further sum to which Owner is entitled, including but not limited to set-offs for liquidated damages and set-offs allowed under the provisions of this Contract with respect to progress payments. Owner shall pay the resulting balance due to Contractor within 30 days of Owner's receipt of the final Application for Payment from Engineer.

#### 15.07 *Waiver of Claims*

- A. By making final payment, Owner waives its claim or right to liquidated damages or other damages for late completion by Contractor, except as set forth in an outstanding Claim,

appeal under the provisions of Article 17, set-off, or express reservation of rights by Owner. Owner reserves all other claims or rights after final payment.

- B. The acceptance of final payment by Contractor will constitute a waiver by Contractor of all claims and rights against Owner other than those pending matters that have been duly submitted as a Claim, or appealed under the provisions of Article 17.

#### 15.08 *Correction Period*

- A. If within one year after the date of Substantial Completion (or such longer period of time as may be prescribed by the Supplementary Conditions or the terms of any applicable special guarantee required by the Contract Documents), Owner gives Contractor written notice that any Work has been found to be defective, or that Contractor's repair of any damages to the Site or adjacent areas has been found to be defective, then after receipt of such notice of defect Contractor shall promptly, without cost to Owner and in accordance with Owner's written instructions:
  - 1. correct the defective repairs to the Site or such adjacent areas;
  - 2. correct such defective Work;
  - 3. remove the defective Work from the Project and replace it with Work that is not defective, if the defective Work has been rejected by Owner, and
  - 4. satisfactorily correct or repair or remove and replace any damage to other Work, to the work of others, or to other land or areas resulting from the corrective measures.
- B. Owner shall give any such notice of defect within 60 days of the discovery that such Work or repairs is defective. If such notice is given within such 60 days but after the end of the correction period, the notice will be deemed a notice of defective Work under Paragraph 7.17.B.
- C. If, after receipt of a notice of defect within 60 days and within the correction period, Contractor does not promptly comply with the terms of Owner's written instructions, or in an emergency where delay would cause serious risk of loss or damage, Owner may have the defective Work corrected or repaired or may have the rejected Work removed and replaced. Contractor shall pay all costs, losses, and damages (including but not limited to all fees and charges of engineers, architects, attorneys, and other professionals and all court or arbitration or other dispute resolution costs) arising out of or relating to such correction or repair or such removal and replacement (including but not limited to all costs of repair or replacement of work of others). Contractor's failure to pay such costs, losses, and damages within 10 days of invoice from Owner will be deemed the start of an event giving rise to a Claim under Paragraph 12.01.B, such that any related Claim must be brought within 30 days of the failure to pay.
- D. In special circumstances where a particular item of equipment is placed in continuous service before Substantial Completion of all the Work, the correction period for that item may start to run from an earlier date if so provided in the Specifications.
- E. Where defective Work (and damage to other Work resulting therefrom) has been corrected or removed and replaced under this paragraph, the correction period hereunder with respect to such Work will be extended for an additional period of one year after such correction or removal and replacement has been satisfactorily completed.

- F. Contractor's obligations under this paragraph are in addition to all other obligations and warranties. The provisions of this paragraph are not to be construed as a substitute for, or a waiver of, the provisions of any applicable statute of limitation or repose.

## **ARTICLE 16—SUSPENSION OF WORK AND TERMINATION**

### **16.01 *Owner May Suspend Work***

- A. At any time and without cause, Owner may suspend the Work or any portion thereof for a period of not more than 90 consecutive days by written notice to Contractor and Engineer. Such notice will fix the date on which Work will be resumed. Contractor shall resume the Work on the date so fixed. Contractor shall be entitled to an adjustment in the Contract Price or an extension of the Contract Times directly attributable to any such suspension. Any Change Proposal seeking such adjustments must be submitted no later than 30 days after the date fixed for resumption of Work.

### **16.02 *Owner May Terminate for Cause***

- A. The occurrence of any one or more of the following events will constitute a default by Contractor and justify termination for cause:
  - 1. Contractor's persistent failure to perform the Work in accordance with the Contract Documents (including, but not limited to, failure to supply sufficient skilled workers or suitable materials or equipment, or failure to adhere to the Progress Schedule);
  - 2. Failure of Contractor to perform or otherwise to comply with a material term of the Contract Documents;
  - 3. Contractor's disregard of Laws or Regulations of any public body having jurisdiction; or
  - 4. Contractor's repeated disregard of the authority of Owner or Engineer.
- B. If one or more of the events identified in Paragraph 16.02.A occurs, then after giving Contractor (and any surety) 10 days' written notice that Owner is considering a declaration that Contractor is in default and termination of the Contract, Owner may proceed to:
  - 1. declare Contractor to be in default, and give Contractor (and any surety) written notice that the Contract is terminated; and
  - 2. enforce the rights available to Owner under any applicable performance bond.
- C. Subject to the terms and operation of any applicable performance bond, if Owner has terminated the Contract for cause, Owner may exclude Contractor from the Site, take possession of the Work, incorporate in the Work all materials and equipment stored at the Site or for which Owner has paid Contractor but which are stored elsewhere, and complete the Work as Owner may deem expedient.
- D. Owner may not proceed with termination of the Contract under Paragraph 16.02.B if Contractor within 7 days of receipt of notice of intent to terminate begins to correct its failure to perform and proceeds diligently to cure such failure.
- E. If Owner proceeds as provided in Paragraph 16.02.B, Contractor shall not be entitled to receive any further payment until the Work is completed. If the unpaid balance of the Contract Price exceeds the cost to complete the Work, including all related claims, costs, losses, and damages (including but not limited to all fees and charges of engineers, architects,

attorneys, and other professionals) sustained by Owner, such excess will be paid to Contractor. If the cost to complete the Work including such related claims, costs, losses, and damages exceeds such unpaid balance, Contractor shall pay the difference to Owner. Such claims, costs, losses, and damages incurred by Owner will be reviewed by Engineer as to their reasonableness and, when so approved by Engineer, incorporated in a Change Order. When exercising any rights or remedies under this paragraph, Owner shall not be required to obtain the lowest price for the Work performed.

- F. Where Contractor's services have been so terminated by Owner, the termination will not affect any rights or remedies of Owner against Contractor then existing or which may thereafter accrue, or any rights or remedies of Owner against Contractor or any surety under any payment bond or performance bond. Any retention or payment of money due Contractor by Owner will not release Contractor from liability.
- G. If and to the extent that Contractor has provided a performance bond under the provisions of Paragraph 6.01.A, the provisions of that bond will govern over any inconsistent provisions of Paragraphs 16.02.B and 16.02.D.

#### 16.03 *Owner May Terminate for Convenience*

- A. Upon 7 days' written notice to Contractor and Engineer, Owner may, without cause and without prejudice to any other right or remedy of Owner, terminate the Contract. In such case, Contractor shall be paid for (without duplication of any items):
  - 1. completed and acceptable Work executed in accordance with the Contract Documents prior to the effective date of termination, including fair and reasonable sums for overhead and profit on such Work;
  - 2. expenses sustained prior to the effective date of termination in performing services and furnishing labor, materials, or equipment as required by the Contract Documents in connection with uncompleted Work, plus fair and reasonable sums for overhead and profit on such expenses; and
  - 3. other reasonable expenses directly attributable to termination, including costs incurred to prepare a termination for convenience cost proposal.
- B. Contractor shall not be paid for any loss of anticipated profits or revenue, post-termination overhead costs, or other economic loss arising out of or resulting from such termination.

#### 16.04 *Contractor May Stop Work or Terminate*

- A. If, through no act or fault of Contractor, (1) the Work is suspended for more than 90 consecutive days by Owner or under an order of court or other public authority, or (2) Engineer fails to act on any Application for Payment within 30 days after it is submitted, or (3) Owner fails for 30 days to pay Contractor any sum finally determined to be due, then Contractor may, upon 7 days' written notice to Owner and Engineer, and provided Owner or Engineer do not remedy such suspension or failure within that time, terminate the contract and recover from Owner payment on the same terms as provided in Paragraph 16.03.
- B. In lieu of terminating the Contract and without prejudice to any other right or remedy, if Engineer has failed to act on an Application for Payment within 30 days after it is submitted, or Owner has failed for 30 days to pay Contractor any sum finally determined to be due, Contractor may, 7 days after written notice to Owner and Engineer, stop the Work until payment is made of all such amounts due Contractor, including interest thereon. The

provisions of this paragraph are not intended to preclude Contractor from submitting a Change Proposal for an adjustment in Contract Price or Contract Times or otherwise for expenses or damage directly attributable to Contractor's stopping the Work as permitted by this paragraph.

## **ARTICLE 17—FINAL RESOLUTION OF DISPUTES**

### **17.01 *Methods and Procedures***

- A. *Disputes Subject to Final Resolution:* The following disputed matters are subject to final resolution under the provisions of this article:
1. A timely appeal of an approval in part and denial in part of a Claim, or of a denial in full, pursuant to Article 12; and
  2. Disputes between Owner and Contractor concerning the Work, or obligations under the Contract Documents, that arise after final payment has been made.
- B. *Final Resolution of Disputes:* For any dispute subject to resolution under this article, Owner or Contractor may:
1. elect in writing to invoke the dispute resolution process provided for in the Supplementary Conditions;
  2. agree with the other party to submit the dispute to another dispute resolution process; or
  3. if no dispute resolution process is provided for in the Supplementary Conditions or mutually agreed to, give written notice to the other party of the intent to submit the dispute to a court of competent jurisdiction.

## **ARTICLE 18—MISCELLANEOUS**

### **18.01 *Giving Notice***

- A. Whenever any provision of the Contract requires the giving of written notice to Owner, Engineer, or Contractor, it will be deemed to have been validly given only if delivered:
1. in person, by a commercial courier service or otherwise, to the recipient's place of business;
  2. by registered or certified mail, postage prepaid, to the recipient's place of business; or
  3. by e-mail to the recipient, with the words "Formal Notice" or similar in the e-mail's subject line.

### **18.02 *Computation of Times***

- A. When any period of time is referred to in the Contract by days, it will be computed to exclude the first and include the last day of such period. If the last day of any such period falls on a Saturday or Sunday or on a day made a legal holiday by the law of the applicable jurisdiction, such day will be omitted from the computation.

18.03 *Cumulative Remedies*

- A. The duties and obligations imposed by these General Conditions and the rights and remedies available hereunder to the parties hereto are in addition to, and are not to be construed in any way as a limitation of, any rights and remedies available to any or all of them which are otherwise imposed or available by Laws or Regulations, by special warranty or guarantee, or by other provisions of the Contract. The provisions of this paragraph will be as effective as if repeated specifically in the Contract Documents in connection with each particular duty, obligation, right, and remedy to which they apply.

18.04 *Limitation of Damages*

- A. With respect to any and all Change Proposals, Claims, disputes subject to final resolution, and other matters at issue, neither Owner nor Engineer, nor any of their officers, directors, members, partners, employees, agents, consultants, or subcontractors, shall be liable to Contractor for any claims, costs, losses, or damages sustained by Contractor on or in connection with any other project or anticipated project.

18.05 *No Waiver*

- A. A party's non-enforcement of any provision will not constitute a waiver of that provision, nor will it affect the enforceability of that provision or of the remainder of this Contract.

18.06 *Survival of Obligations*

- A. All representations, indemnifications, warranties, and guarantees made in, required by, or given in accordance with the Contract, as well as all continuing obligations indicated in the Contract, will survive final payment, completion, and acceptance of the Work or termination of the Contract or of the services of Contractor.

18.07 *Controlling Law*

- A. This Contract is to be governed by the law of the state in which the Project is located.

18.08 *Assignment of Contract*

- A. Unless expressly agreed to elsewhere in the Contract, no assignment by a party to this Contract of any rights under or interests in the Contract will be binding on the other party without the written consent of the party sought to be bound; and, specifically but without limitation, money that may become due and money that is due may not be assigned without such consent (except to the extent that the effect of this restriction may be limited by law), and unless specifically stated to the contrary in any written consent to an assignment, no assignment will release or discharge the assignor from any duty or responsibility under the Contract.

18.09 *Successors and Assigns*

- A. Owner and Contractor each binds itself, its successors, assigns, and legal representatives to the other party hereto, its successors, assigns, and legal representatives in respect to all covenants, agreements, and obligations contained in the Contract Documents.

18.10 *Headings*

- A. Article and paragraph headings are inserted for convenience only and do not constitute parts of these General Conditions.



**C-800 2018  
Supplementary Conditions  
of the Construction Contract**

**Vernon Avenue Improvements**

**OT1.129866**

**Lower Minnesota River Watershed District**

**Savage, MN**

# Supplementary Conditions of the Construction Contract

	Page
ARTICLE 1–Definitions and Terminology	1
ARTICLE 2–Preliminary Matters	1
ARTICLE 3–Contract Documents: Intent, Requirements, Reuse	5
ARTICLE 4–Commencement and Progress of the Work	5
ARTICLE 5–Site, Subsurface and Physical Conditions, Hazardous Environmental Conditions	6
ARTICLE 6–Bonds and Insurance	7
ARTICLE 7–Contractor's Responsibilities	12
ARTICLE 8–Other Work at the Site	12
ARTICLE 9–Owner's Responsibility	12
ARTICLE 10–Engineer's Status During Construction	12
ARTICLE 11–Changes to the Contract	14
ARTICLE 12–Claims	14
ARTICLE 13–Cost of Work; Allowances, Unit Price Work	14
ARTICLE 14–Tests and Inspections; Correction, Removal, or Acceptance of Defective Work	14
ARTICLE 15–Payments to Contractor, Set Offs; Completions; Correction Period	14
ARTICLE 16–Suspension of Work and Termination	16
ARTICLE 17–Final Resolution of Dispute	16
ARTICLE 18–Miscellaneous	16

# SUPPLEMENTARY CONDITIONS OF THE CONSTRUCTION CONTRACT

These Supplementary Conditions amend or supplement EJCDC® C 700, Standard General Conditions of the Construction Contract (2018). The General Conditions remain in full force and effect except as amended.

The terms used in these Supplementary Conditions have the meanings stated in the General Conditions. Additional terms used in these Supplementary Conditions have the meanings stated below, which are applicable to both the singular and plural thereof.

The address system used in these Supplementary Conditions is the same as the address system used in the General Conditions, with the prefix "SC" added—for example, "Paragraph SC-4.05."

## ARTICLE 1—DEFINITIONS AND TERMINOLOGY

### 1.01 Defined Terms

SC-1.01.A.33 Insert the following sentence at the end of Paragraph 1.01.A.33:

The term Construction Project Representative (CPR) shall have the same meaning as RPR.

SC-1.01.A.42. Delete Paragraph 1.01.A.42 in its entirety and insert the following in its place:

42. Substantial Completion – Substantial Completion shall be as defined in the Agreement.

## ARTICLE 2—PRELIMINARY MATTERS

### 2.01 Delivery of Bonds and Evidence of Insurance

SC-2.01 Delete Paragraphs 2.01.B. and C. in their entirety and insert the following in their place:

B. Evidence of Contractor's Insurance: When Contractor delivers the signed counterparts of the Agreement to Owner, Contractor shall also deliver to Owner copies of the policies (including all endorsements, and identification of applicable self-insured retentions and deductibles) of insurance required to be provided by Contractor in this Contract.

Contractor may block out (redact) any confidential premium or pricing information contained in any policy or endorsement furnished under this provision.

C. Evidence of Owner's Insurance: After receipt from Contractor of the signed counterparts of the Agreement and all required bonds and insurance documentation, Owner shall promptly deliver to Contractor copies of the policies of insurance to be provided by Owner in this Contract (if any). Owner may block out (redact) any confidential premium or pricing information contained in any policy or endorsement furnished under this provision.

### 2.02 Copies of Documents

SC-2.02 Amend the first sentence of Paragraph 2.02.A. to read as follows:

A. Owner shall furnish to Contractor four printed copies of the Contract Documents (including one fully signed counterpart of the Agreement), and one in electronic portable document format (PDF).

### 2.06 Electronic Transmittals

SC-2.06 Delete Paragraphs 2.06.B and 2.06.C in their entirety and insert the following in their place:

---

This document is a MODIFIED version of EJCDC® C-800, Copyright© 2018 by NSPE, ACEC, and ASCE. All rights reserved.

- B. Electronic Documents Protocol: The parties shall conform to the following provisions in Paragraphs 2.06.B and 2.06.C, together referred to as the Electronic Documents Protocol (“EDP” or “Protocol”) for exchange of electronic transmittals.
1. Basic Requirements
    - a. To the fullest extent practical, the parties agree to and will transmit and accept Electronic Documents in an electronic or digital format using the procedures described in this Protocol. Use of the Electronic Documents and any information contained therein is subject to the requirements of this Protocol and other provisions of the Contract.
    - b. The contents of the information in any Electronic Document will be the responsibility of the transmitting party.
    - c. Electronic Documents as exchanged by this Protocol may be used in the same manner as the printed versions of the same documents that are exchanged using non-electronic format and methods, subject to the same governing requirements, limitations, and restrictions, set forth in the Contract Documents.
    - d. Except as otherwise explicitly stated herein, the terms of this Protocol will be incorporated into any other agreement or subcontract between a party and any third party for any portion of the Work on the Project, or any Project-related services, where that third party is, either directly or indirectly, required to exchange Electronic Documents with a party or with Engineer. Nothing herein will modify the requirements of the Contract regarding communications between and among the parties and their subcontractors and consultants.
    - e. When transmitting Electronic Documents, the transmitting party makes no representations as to long term compatibility, usability, or readability of the items resulting from the receiving party’s use of software application packages, operating systems, or computer hardware differing from those established in this Protocol.
    - f. Nothing herein negates any obligation 1) in the Contract to create, provide, or maintain an original printed record version of Drawings and Specifications, signed, and sealed according to applicable Laws and Regulations; 2) to comply with any applicable Law or Regulation governing the signing and sealing of design documents or the signing and electronic transmission of any other documents; or 3) to comply with the notice requirements of Paragraph 18.01 of the General Conditions.
  2. System Infrastructure for Electronic Document Exchange
    - a. Each party will provide hardware, operating system(s) software, internet, e-mail, and large file transfer functions (“System Infrastructure”) at its own cost and sufficient for complying with the EDP requirements. With the exception of minimum standards set forth in this EDP, and any explicit system requirements specified by attachment to this EDP, it is the obligation of each party to determine, for itself, its own System Infrastructure.

- 1) The maximum size of an email attachment for exchange of Electronic Documents under this EDP is 5 MB. Attachments larger than that may be exchanged using large file transfer functions or physical media.
  - 2) Each Party assumes full and complete responsibility for any and all of its own costs, delays, deficiencies, and errors associated with converting, translating, updating, verifying, licensing, or otherwise enabling its System Infrastructure, including operating systems and software, for use with respect to this EDP.
- b. Each party is responsible for its own system operations, security, back-up, archiving, audits, printing resources, and other Information Technology (“IT”) for maintaining operations of its System Infrastructure during the Project, including coordination with the party’s individual(s) or entity responsible for managing its System Infrastructure and capable of addressing routine communications and other IT issues affecting the exchange of Electronic Documents.
  - c. Each party will operate and maintain industry-standard, industry-accepted, ISO standard, commercial-grade security software and systems that are intended to protect the other party from: software viruses and other malicious software like worms, trojans, adware; data breaches; loss of confidentiality; and other threats in the transmission to or storage of information from the other parties, including transmission of Electronic Documents by physical media such as CD/DVD/flash drive/hard drive. To the extent that a party maintains and operates such security software and systems, it shall not be liable to the other party for any breach of system security.
  - d. In the case of disputes, conflicts, or modifications to the EDP required to address issues affecting System Infrastructure, the parties shall cooperatively resolve the issues; but, failing resolution, the Owner is authorized to make and require reasonable and necessary changes to the EDP to effectuate its original intent. If the changes cause additional cost or time to Contractor, not reasonably anticipated under the original EDP, Contractor may seek an adjustment in price or time under the appropriate process in the Contract.
  - e. Each party is responsible for its own back-up and archive of documents sent and received during the term of the contract under this EDP, unless this EDP establishes a Project document archive, either as part of a mandatory Project website or other communications protocol, upon which the parties may rely for document archiving during the specified term of operation of such Project document archive. Further, each party remains solely responsible for its own post-Project back-up and archive of Project documents after the term of the Contract, or after termination of the Project document archive, if one is established, for as long as required by the Contract and as each party deems necessary for its own purposes.
  - f. If a receiving party receives an obviously corrupted, damaged, or unreadable Electronic Document, the receiving party will advise the sending party of the incomplete transmission.
  - g. The parties will bring any non-conforming Electronic Documents into compliance with the EDP. The parties will attempt to complete a successful transmission of

the Electronic Document or use an alternative delivery method to complete the communication.

C. Software Requirements for Electronic Document Exchange; Limitations

1. Each party will acquire the software and software licenses necessary to create and transmit Electronic Documents and to read and to use any Electronic Documents received from the other party (and if relevant from third parties), using the software formats required in this section of the EDP.
  - a. Prior to using any updated version of the software required in this section for sending Electronic Documents to the other party, the originating party will first notify and receive concurrence from the other party for use of the updated version or adjust its transmission to comply with this EDP.
2. The parties agree not to intentionally edit, reverse engineer, decrypt, remove security or encryption features, or convert to another format for modification purposes any Electronic Document or information contained therein that was transmitted in a software data format, including Portable Document Format (PDF), intended by sender not to be modified, unless the receiving party obtains the permission of the sending party or is citing or quoting excerpts of the Electronic Document for Project purposes.
3. Software and data formats for exchange of Electronic Documents will conform to the requirements set forth in Exhibit A to this EDP, including software versions, if listed.

SC-2.06 Supplement Paragraph 2.06 of the General Conditions by adding the following paragraph:

D. Requests by Contractor for Electronic Documents in Other Formats

1. Release of any Electronic Document versions of the Project documents in formats other than those identified in the Electronic Documents Protocol (if any) or elsewhere in the Contract will be at the sole discretion of the Owner.
2. To extent determined by Owner, in its sole discretion, to be prudent and necessary, release of Electronic Documents versions of Project documents and other Project information requested by Contractor ("Request") in formats other than those identified in the Electronic Documents Protocol (if any) or elsewhere in the Contract will be subject to the provisions of the Owner's response to the Request, and to the following conditions to which Contractor agrees:
  - a. The content included in the Electronic Documents created by Engineer and covered by the Request was prepared by Engineer as an internal working document for Engineer's purposes solely and is being provided to Contractor on an "AS IS" basis without any warranties of any kind, including, but not limited to any implied warranties of fitness for any purpose. As such, Contractor is advised and acknowledges that the content may not be suitable for Contractor's application or may require substantial modification and independent verification by Contractor. The content may include limited resolution of models, not-to-scale schematic representations and symbols, use of notes to convey design concepts in lieu of accurate graphics, approximations, graphical simplifications, undocumented intermediate revisions, and other devices that may affect subsequent reuse.

- b. Electronic Documents containing text, graphics, metadata, or other types of data that are provided by Engineer to Contractor under the request are only for convenience of Contractor. Any conclusion or information obtained or derived from such data will be at the Contractor’s sole risk and the Contractor waives any claims against Engineer or Owner arising from use of data in Electronic Documents covered by the Request.
  - c. Contractor shall indemnify and hold harmless Owner and Engineer and their subconsultants from all claims, damages, losses, and expenses, including attorneys' fees and defense costs arising out of or resulting from Contractor’s use, adaptation, or distribution of any Electronic Documents provided under the Request.
  - d. Contractor agrees not to sell, copy, transfer, forward, give away or otherwise distribute this information (in source or modified file format) to any third party without the direct written authorization of Engineer, unless such distribution is specifically identified in the Request and is limited to Contractor’s subcontractors. Contractor warrants that subsequent use by Contractor’s subcontractors complies with all terms of the Contract Documents and Owner’s response to Request.
3. In the event that Owner elects to provide or directs the Engineer to provide to Contractor any Contractor-requested Electronic Document versions of Project information that is not explicitly identified in the Contract Documents as being available to Contractor, the Owner shall be reimbursed by Contractor on an hourly basis (at \$150 per hour) for any engineering costs necessary to create or otherwise prepare the data in a manner deemed appropriate by Engineer.

**ARTICLE 3—CONTRACT DOCUMENTS: INTENT, REQUIREMENTS, REUSE**

3.01 Intent

No Supplementary Conditions in this Article.

**ARTICLE 4—COMMENCEMENT AND PROGRESS OF THE WORK**

4.03 Reference Points

4.03.A. Delete Paragraph 4.03.A of the General Conditions in its entirety and insert the following Paragraph 4.03.A in its place:

- A. The OWNER will provide engineering surveys to establish reference points for construction.

4.05 Delays in Contractor’s Progress

SC-4.05 Amend Paragraph 4.05.C by adding the following subparagraphs:

- 5. Weather-Related Delays
  - a. If “abnormal weather conditions” as set forth in Paragraph 4.05.C.2 of the General Conditions are the basis for a request for an equitable adjustment in the Contract Times, such request must be documented by data substantiating each of the following: 1) that weather conditions were abnormal for the period of time in which the delay occurred, 2) that such weather conditions could not have been reasonably anticipated, and 3) that such weather conditions had an adverse effect on the Work as scheduled.

- b. The existence of abnormal weather conditions will be determined on a month-by-month basis in accordance with the following:
  - 1) Contractor shall anticipate the number of foreseeable bad weather days per month indicated in the Table 1803-2—Anticipated Work Days Lost Due to Weather in MnDOT Standard Specifications for Construction. The days in Table 1803-2 are cumulative and the number of allowable bad weather days will be determined by totaling the monthly number of days throughout the specified Contract Time. The days in Table 1803-2 will prorated when Contract Time starts or ends mid-month.
  - 2) Work days lost to inclement weather exceeding the allowable number, established as described in Paragraph 4.05.C.2 will be considered as “abnormal weather conditions.” The existence of abnormal weather conditions will not relieve Contractor of the obligation to demonstrate and document that delays caused by abnormal weather are specific to the planned work activities or that such activities thus delayed were on Contractor’s then-current Progress Schedule’s critical path for the Project.
  - 3) The Owner will not consider weekends or holidays, as eligible for extensions of Contract Time due to weather unless the Engineer or Owner directs the Contractor to work those days, or the Contractor’s accepted progress schedule in place at the time the delay occurred indicated that the Contractor intended to perform Critical Path Work on those days.

**ARTICLE 5—SITE, SUBSURFACE AND PHYSICAL CONDITIONS, HAZARDOUS ENVIRONMENTAL CONDITIONS**

5.03 Subsurface and Physical Conditions

SC-5.03 Add the following new paragraphs immediately after Paragraph 5.03.D:

- E. The following table lists the reports of explorations and tests of subsurface conditions at or adjacent to the Site that contain Technical Data, and specifically identifies the Technical Data in the report upon which Contractor may rely:

Report Title	Date of Report	Technical Data
Geotechnical Evaluation Report	08/02/2023	Data contained in boring logs, recorded measurements of subsurface water levels, and other factual, objective information regarding conditions at the Site.

- F. The following table lists the drawings of existing physical conditions at or adjacent to the Site, including those drawings depicting existing surface or subsurface structures at or adjacent to the Site (except Underground Facilities), that contain Technical Data, and specifically identifies the Technical Data upon which Contractor may rely:

Drawings Title	Date of Drawings	Technical Data
“There are no drawings the Contractor may rely.”		



- G. Contractor may examine copies of reports and drawings identified in SC-5.03.E and SC-5.03.F that were not included with the Bidding Documents at 12224 Nicollet Avenue, Burnsville, MN 55337-1649, (952) 890-0509, fax (952) 890-8065 during regular business hours or may request copies from Engineer.

5.06 Hazardous Environmental Conditions

SC-5.06 Add the following new paragraphs immediately after Paragraph 5.06.A.3:

- 4. The following table lists the reports known to Owner relating to Hazardous Environmental Conditions at or adjacent to the Site, and the Technical Data (if any) upon which Contractor may rely:

Report Title	Date of Report	Technical Data
"There are no reports the Contractor may rely."		

- 5. The following table lists the drawings known to Owner relating to Hazardous Environmental Conditions at or adjacent to the Site, and Technical Data (if any) contained in such Drawings upon which Contractor may rely:

Drawings Title	Date of Drawings	Technical Data
"There are no drawings the Contractor may rely."		

5.07 Add the following new section immediately after Section 5.06:

5.07 – *Inadvertent Discoveries*

- A. The contractor is cautioned that disturbance of historical objects may be subject to criminal or civil penalties.
- B. If potential historic objects are found within the project limits, the Contractor shall:
  - 1. Suspend operations in the immediate area of the discovery and protect from construction operations.
  - 2. Notify the Engineer of the presence of potential historical objects.
  - 3. The Contractor shall not perform work that the Contractor considers Extra Work without the written approval of the Engineer.
  - 4. Work may be restricted or suspended in the Immediate area of the historical objects for a period not to exceed 72 hours without a Contractor claim for damages. No restrictions or suspension shall be imposed over 72 hours unless agreed by the Contractor and the Owner in writing.

**ARTICLE 6—BONDS AND INSURANCE**

6.01 Performance, Payment, and Other Bonds

SC-6.01 Add the following paragraphs immediately after Paragraph 6.01.A:

- 1. Required Performance Bond Form: The performance bond that Contractor furnishes will be in the form of EJCDC® C 610, Performance Bond (2010, 2013, or 2018 edition).
- 2. Required Payment Bond Form: The payment bond that Contractor furnishes will be in the form of EJCDC® C 615, Payment Bond (2010, 2013, or 2018 edition).

This document is a MODIFIED version of EJCDC® C-800, Copyright© 2018 by NSPE, ACEC, and ASCE. All rights reserved.

- SC-6.01 Add the following paragraphs immediately after Paragraph 6.01.B:
1. The correction period specified as one year after the date of Substantial Completion in Paragraph 15.08.A of the General Conditions is hereby revised to be 2 years after Substantial Completion.
  2. After Substantial Completion, Contractor shall furnish a warranty bond issued in the form of EJCDC® C 612, Warranty Bond (2018). The warranty bond must be in a bond amount of 10 percent of the final Contract Price. The warranty bond period will extend to a date 2 years after Substantial Completion of the Work. Contractor shall deliver the fully executed warranty bond to Owner prior to final payment, and in any event no later than 11 months after Substantial Completion.
  3. The warranty bond must be issued by the same surety that issues the performance bond required under Paragraph 6.01.A of the General Conditions.

6.02 Insurance—General Provisions

- SC-6.02 Add the following paragraph immediately after Paragraph 6.02.B:
1. Contractor may obtain worker’s compensation insurance from an insurance company that has not been rated by A.M. Best, provided that such company (a) is domiciled in the state in which the Project is located, (b) is certified or authorized as a worker’s compensation insurance provider by the appropriate state agency, and (c) has been accepted to provide worker’s compensation insurance for similar projects by the state within the last 12 months.

6.03 Contractor’s Insurance

- SC-6.03 Supplement Paragraph 6.03 with the following provisions after Paragraph 6.03.C:
- D. Other Additional Insureds: As a supplement to the provisions of Paragraph 6.03.C of the General Conditions, the commercial general liability, automobile liability, umbrella or excess, pollution liability, and unmanned aerial vehicle liability policies must include as additional insureds (in addition to Owner and Engineer) the following: City of Savage
  - E. Workers’ Compensation and Employer’s Liability: Contractor shall purchase and maintain workers’ compensation and employer’s liability insurance, including, as applicable, United States Longshoreman and Harbor Workers’ Compensation Act, Jones Act, stop-gap employer’s liability coverage for monopolistic states, and foreign voluntary workers’ compensation (from available sources, notwithstanding the jurisdictional requirement of Paragraph 6.02.B of the General Conditions).

<b>Workers’ Compensation and Related Policies</b>	<b>Policy limits of not less than:</b>
<b>Workers’ Compensation</b>	
State	Statutory
Applicable Federal (e.g., Longshoreman’s)	Statutory
Foreign voluntary workers’ compensation (employer’s responsibility coverage), if applicable	Statutory
<b>Jones Act (if applicable)</b>	
Bodily injury by accident—each accident	Not Applicable
Bodily injury by disease—aggregate	Not Applicable
<b>Employer’s Liability</b>	

This document is a MODIFIED version of EJCDC® C-800, Copyright© 2018 by NSPE, ACEC, and ASCE. All rights reserved.

<b>Workers' Compensation and Related Policies</b>	<b>Policy limits of not less than:</b>
Each accident	\$1,000,000.00
Each employee	\$1,000,000.00
Policy limit	\$1,000,000.00
<b>Stop-gap Liability Coverage</b>	
For work performed in monopolistic states, stop-gap liability coverage must be endorsed to either the worker's compensation or commercial general liability policy with a minimum limit of:	Not Applicable

- F. Commercial General Liability—Claims Covered: Contractor shall purchase and maintain commercial general liability insurance, covering all operations by or on behalf of Contractor, on an occurrence basis, against claims for:
1. damages because of bodily injury, sickness or disease, or death of any person other than Contractor's employees,
  2. damages insured by reasonably available personal injury liability coverage, and
  3. damages because of injury to or destruction of tangible property wherever located, including loss of use resulting therefrom.
- G. Commercial General Liability—Form and Content: Contractor's commercial liability policy must be written on a 1996 (or later) Insurance Services Organization, Inc. (ISO) commercial general liability form (occurrence form) and include the following coverages and endorsements:
1. Products and completed operations coverage.
    - a. Such insurance must be maintained for three years after final payment.
    - b. Contractor shall furnish Owner and each other additional insured (as identified in the Supplementary Conditions or elsewhere in the Contract) evidence of continuation of such insurance at final payment and three years thereafter.
  2. Blanket contractual liability coverage, including but not limited to coverage of Contractor's contractual indemnity obligations in Paragraph 7.18.
  3. Severability of interests and no insured-versus-insured or cross-liability exclusions.
  4. Underground, explosion, and collapse coverage.
  5. Personal injury coverage.
  6. Additional insured endorsements that include both ongoing operations and products and completed operations coverage through ISO Endorsements CG 20 10 10 01 and CG 20 37 10 01 (together). If Contractor demonstrates to Owner that the specified ISO endorsements are not commercially available, then Contractor may satisfy this requirement by providing equivalent endorsements.
  7. For design professional additional insureds, ISO Endorsement CG 20 32 07 04 "Additional Insured—Engineers, Architects or Surveyors Not Engaged by the Named Insured" or its equivalent.

- H. Commercial General Liability—Excluded Content: The commercial general liability insurance policy, including its coverages, endorsements, and incorporated provisions, must not include any of the following:
1. Any modification of the standard definition of “insured contract” (except to delete the railroad protective liability exclusion if Contractor is required to indemnify a railroad or others with respect to Work within 50 feet of railroad property).
  2. Any exclusion for water intrusion or water damage.
  3. Any provisions resulting in the erosion of insurance limits by defense costs other than those already incorporated in ISO form CG 00 01.
  4. Any exclusion of coverage relating to earth subsidence or movement.
  5. Any exclusion for the insured’s vicarious liability, strict liability, or statutory liability (other than worker’s compensation).
  6. Any limitation or exclusion based on the nature of Contractor’s work.
  7. Any professional liability exclusion broader in effect than the most recent edition of ISO form CG 22 79.

I. Commercial General Liability—Minimum Policy Limits

<b>Commercial General Liability</b>	<b>Policy limits of not less than:</b>
General Aggregate	\$2,000,000.00
Products—Completed Operations Aggregate	\$2,000,000.00
Personal and Advertising Injury	\$1,000,000.00
Bodily Injury and Property Damage—Each Occurrence	\$1,000,000.00

- J. Automobile Liability: Contractor shall purchase and maintain automobile liability insurance for damages because of bodily injury or death of any person or property damage arising out of the ownership, maintenance, or use of any motor vehicle. The automobile liability policy must be written on an occurrence basis.

<b>Automobile Liability</b>	<b>Policy limits of not less than:</b>
<b>Bodily Injury</b>	
Each Person	\$1,000,000.00
Each Accident	\$1,000,000.00
<b>Property Damage</b>	
Each Accident	\$1,000,000.00
<b>[or]</b>	
<b>Combined Single Limit</b>	
Combined Single Limit (Bodily Injury and Property Damage)	\$1,000,000.00

- K. Umbrella or Excess Liability: Contractor shall purchase and maintain umbrella or excess liability insurance written over the underlying employer’s liability, commercial general liability, and automobile liability insurance described in the Paragraphs above. The coverage afforded must be at least as broad as that of each and every one of the underlying policies.

<b>Excess or Umbrella Liability</b>	<b>Policy limits of not less than:</b>
Each Occurrence	Not Applicable
General Aggregate	Not Applicable

L. Using Umbrella or Excess Liability Insurance to Meet CGL and Other Policy Limit Requirements: Contractor may meet the policy limits specified for employer’s liability, commercial general liability, and automobile liability through the primary policies alone, or through combinations of the primary insurance policy’s policy limits and partial attribution of the policy limits of an umbrella or excess liability policy that is at least as broad in coverage as that of the underlying policy, as specified herein. If such umbrella or excess liability policy was required under this Contract, at a specified minimum policy limit, such umbrella or excess policy must retain a minimum limit of \$0 after accounting for partial attribution of its limits to underlying policies, as allowed above.

M. Contractor’s Pollution Liability Insurance: Contractor shall purchase and maintain a policy covering third-party injury and property damage, including cleanup costs, as a result of pollution conditions arising from Contractor’s operations and completed operations. This insurance must be maintained for no less than three years after final completion.

<b>Contractor’s Pollution Liability</b>	<b>Policy limits of not less than:</b>
Each Occurrence/Claim	Not Applicable
General Aggregate	Not Applicable

N. Contractor’s Professional Liability Insurance: If Contractor will provide or furnish professional services under this Contract, through a delegation of professional design services or otherwise, then Contractor shall be responsible for purchasing and maintaining applicable professional liability insurance. This insurance must cover negligent acts, errors, or omissions in the performance of professional design or related services by the insured or others for whom the insured is legally liable. The insurance must be maintained throughout the duration of the Contract and for a minimum of two years after Substantial Completion. The retroactive date on the policy must pre-date the commencement of furnishing services on the Project.

<b>Contractor’s Professional Liability</b>	<b>Policy limits of not less than:</b>
Each Claim	Not Applicable
Annual Aggregate	Not Applicable

O. Railroad Protective Liability Insurance: Prior to commencing any Work within 50 feet of railroad-owned and controlled property, Contractor shall (1) endorse its commercial general liability policy with ISO CG 24 17, removing the contractual liability exclusion for work within 50 feet of a railroad, (2) purchase and maintain railroad protective liability insurance meeting the following requirements, (3) furnish a copy of the endorsement to Owner, and (4) submit a copy of the railroad protective policy and other railroad-required documentation to the railroad, and notify Owner of such submittal.

**See “Exhibit A – Insurance Provisions for Contractor Endorsement” included in Appendix B – Work in UP Railroad ROW Associated Documents for the specific additional railroad insurance requirements for this project.** Additional railroad requirements are included in Section 01 41 26 (Permit Requirements) and Appendix B of this Project Manual.

P. Unmanned Aerial Vehicle Liability Insurance: No Supplementary Conditions in this Article.

This document is a MODIFIED version of EJCDC® C-800, Copyright© 2018 by NSPE, ACEC, and ASCE. All rights reserved.

Q. Other Required Insurance: No Supplementary Conditions in this Article.

6.04 Builder's Risk and Other Property Insurance: No Supplementary Conditions in this Article.

#### **ARTICLE 7—CONTRACTOR'S RESPONSIBILITIES**

7.03 Labor; Working Hours

SC-7.03 Add the following new subparagraphs immediately after Paragraph 7.03.C:

1. Regular working hours will be 7:00 A.M. to 7:00 P.M. Monday - Friday and 8:00 A.M. to 6:00 P.M. Saturday with 48-hour notice and Owner Approval.
2. Owner's legal holidays are: New Year's Day, January 1; Martin Luther King's Birthday, the third Monday in January; Washington's and Lincoln's Birthday, the third Monday in February; Memorial Day, the last Monday in May; Juneteenth, June 19; Independence Day, July 4; Labor Day, the first Monday in September; Christopher Columbus Day, the second Monday in October; Veterans Day, November 11; Thanksgiving Day, the fourth Thursday in November; and Christmas Day, December 25.
3. When a legal holiday occurs on Sunday, the subsequent Monday shall be the observed holiday. When a legal holiday occurs on Saturday, the preceding Friday shall be the observed holiday.

#### **ARTICLE 8—OTHER WORK AT THE SITE**

No Supplementary Conditions in this Article.

#### **ARTICLE 9—OWNER'S RESPONSIBILITIES**

Owner's Site Representative. No Supplementary Conditions in this Article.

#### **ARTICLE 10—ENGINEER'S STATUS DURING CONSTRUCTION**

10.03 Resident Project Representative

SC-10.03 Add the following new paragraphs immediately after Paragraph 10.03.B:

- C. The Resident Project Representative (RPR) will be Engineer's representative at the Site. RPR's dealings in matters pertaining to the Work in general will be with Engineer and Contractor. RPR's dealings with Subcontractors will only be through or with the full knowledge or approval of Contractor. The RPR will:
  1. Conferences and Meetings: Attend meetings with Contractor, such as preconstruction conferences, progress meetings, job conferences, and other Project-related meetings (but not including Contractor's safety meetings), and as appropriate prepare and circulate copies of minutes thereof.
  2. Safety Compliance: Comply with Site safety programs, as they apply to RPR, and if required to do so by such safety programs, receive safety training specifically related to RPR's own personal safety while at the Site.
  3. Liaison
    - a. Serve as Engineer's liaison with Contractor. Working principally through Contractor's authorized representative or designee, assist in providing information regarding the provisions and intent of the Contract Documents.

This document is a MODIFIED version of EJDC® C-800, Copyright© 2018 by NSPE, ACEC, and ASCE. All rights reserved.

- b. Assist Engineer in serving as Owner's liaison with Contractor when Contractor's operations affect Owner's on-site operations.
  - c. Assist in obtaining from Owner additional details or information, when required for Contractor's proper execution of the Work.
4. Review of Work; Defective Work
- a. Conduct on-site observations of the Work to assist Engineer in determining, to the extent set forth in Paragraph 10.02 if the Work is in general proceeding in accordance with the Contract Documents.
  - b. Observe whether any Work in place appears to be defective.
  - c. Observe whether any Work in place should be uncovered for observation, or requires special testing, inspection, or approval.
5. Inspections and Tests
- a. Observe Contractor-arranged inspections required by Laws and Regulations, including but not limited to those performed by public or other agencies having jurisdiction over the Work.
  - b. Accompany visiting inspectors representing public or other agencies having jurisdiction over the Work.
6. Payment Requests: Review Applications for Payment with Contractor.
7. Completion
- a. Participate in Engineer's visits regarding Substantial Completion.
  - b. Assist in the preparation of a punch list of items to be completed or corrected.
  - c. Participate in Engineer's visit to the Site in the company of Owner and Contractor regarding completion of the Work and prepare a final punch list of items to be completed or corrected by Contractor.
  - d. Observe whether items on the final punch list have been completed or corrected.
- D. The RPR will not:
- 1. Authorize any deviation from the Contract Documents or substitution of materials or equipment (including "or-equal" items).
  - 2. Exceed limitations of Engineer's authority as set forth in the Contract Documents.
  - 3. Undertake any of the responsibilities of Contractor, Subcontractors, or Suppliers.
  - 4. Advise on, issue directions relative to, or assume control over any aspect of the means, methods, techniques, sequences, or procedures of construction.
  - 5. Advise on, issue directions regarding, or assume control over security or safety practices, precautions, and programs in connection with the activities or operations of Owner or Contractor.
  - 6. Participate in specialized field or laboratory tests or inspections conducted off-site by others except as specifically authorized by Engineer.

7. Authorize Owner to occupy the Project in whole or in part.

**ARTICLE 11—CHANGES TO THE CONTRACT**

SC-11.02.C Insert the following after 11.02.B

- C. In complying with any Minnesota Governmental Data Practices Act (MGDPA) request, Contractor will be reimbursed by Change Order only for its reasonable direct labor and other direct expenses, without mark-up or increase in 11.07.C. Fee; but only to the extent that the request is not due to a negligent, intentional, or willful act or omission by the Contractor or other failure to comply with its obligations under this contract.

**ARTICLE 12—CLAIMS**

No Supplementary Conditions in this Article.

**ARTICLE 13—COST OF WORK; ALLOWANCES, UNIT PRICE WORK**

SC-13.01 Supplement Paragraph 13.01.C.2 by adding the following definition of small tools and hand tools:

- a. For purposes of this paragraph, “small tools and hand tools” means any tool or equipment whose current price if it were purchased new at retail would be less than \$500.

13.03 Unit Price Work

SC-13.03 Delete Paragraph 13.03.E in its entirety and insert the following in its place:

- E. Adjustments in Unit Price
  1. Contractor or Owner shall be entitled to an adjustment in the unit price with respect to an item of Unit Price Work if:
    - a. the extended price of a particular item of Unit Price Work amounts to five percent or more of the Contract Price and the variation in the quantity of that particular item of Unit Price Work actually furnished or performed by Contractor differs by more than twenty percent from the estimated quantity of such item indicated in the Agreement; and
    - b. Contractor’s unit costs to perform the item of Unit Price Work have changed materially and significantly as a result of the quantity change.
  2. The adjustment in unit price will account for and be coordinated with any related changes in quantities of other items of Work, and in Contractor’s costs to perform such other Work, such that the resulting overall change in Contract Price is equitable to Owner and Contractor.
  3. Adjusted unit prices will apply to all units of that item.

**ARTICLE 14—TESTS AND INSPECTIONS; CORRECTION, REMOVAL, OR ACCEPTANCE OF DEFECTIVE WORK**

No Supplementary Conditions in this Article.

**ARTICLE 15—PAYMENTS TO CONTRACTOR, SET OFFS; COMPLETIONS; CORRECTION PERIOD**

15.01 Progress Payments

---

This document is a MODIFIED version of EJCDC® C-800, Copyright© 2018 by NSPE, ACEC, and ASCE. All rights reserved.



SC-15.01.B Replace Paragraph 15.01.B.1 with the following:

1. The Engineer shall, in communication with Contractor, prepare a draft partial payment estimate on or about the day as specified in Article 6 of the Agreement in any given month where significant work has been completed. The Pay Estimate shall then be forwarded to the Contractor for its review, approval, and submittal. If payment is requested on the basis of materials and equipment not incorporated in the Work but delivered and suitably stored at the Site or at another location agreed to in writing, the Application for Payment shall also be accompanied by a bill of sale, invoice, or other documentation warranting that Owner has received the materials and equipment free and clear of all liens and evidence that the materials and equipment are covered by appropriate property insurance or other arrangements to protect the Owner's interest therein, all of which must be satisfactory to Owner.

SC-15.01.C Delete paragraph 15.01.C.1 in its entirety.

SC-15.01.D Delete Paragraph 15.01.D.1 in its entirety and replace with the following:

1. The time period for payment shall be in accordance with the Agreement.

SC-15.01.E.1 Add the following new Paragraph 15-01.E.1.m

- m. All out-of-state contractors shall comply with all State of Minnesota surety deposit requirements. The OWNER may withhold an additional sum of 8 percent of the amount due the CONTRACTOR from each payment and forward it to the Department of Revenue until the CONTRACTOR's state tax obligations are considered fulfilled unless the CONTRACTOR can show reason for exemption. Exemption will be granted provided the out-of-state CONTRACTOR meets the exemption guidelines established for the Minnesota Department of Revenue. All necessary forms may be obtained from the Minnesota Department of Revenue, Mail Station 4450, St. Paul, Minnesota 55146-4450, or phone 1-800-657-3777 or online at:  
<http://www.revenue.state.mn.us/businesses/withholding/Pages/Forms.aspx>.

SC-15.01 Add the following new Paragraph 15.01.F:

- F. For contracts in which the Contract Price is based on the Cost of Work, if Owner determines that progress payments made to date substantially exceed the actual progress of the Work (as measured by reference to the Schedule of Values), or present a potential conflict with the Guaranteed Maximum Price, then Owner may require that Contractor prepare and submit a plan for the remaining anticipated Applications for Payment that will bring payments and progress into closer alignment and take into account the Guaranteed Maximum Price (if any), through reductions in billings, increases in retainage, or other equitable measures. Owner will review the plan, discuss any necessary modifications, and implement the plan as modified for all remaining Applications for Payment.

15.03 Substantial Completion

SC-15.03.A. Delete Paragraph 15.03.A. in its entirety and replace with the following:

- A. When Contractor considers the entire Work to be substantially complete Contractor shall notify Owner and Engineer in writing that the entire Work is substantially complete and request that Engineer issue a certificate of Substantial Completion. Contractor shall at the

same time submit to Owner and Engineer an initial draft of punch list items to be completed or corrected before final payment.

SC-15.03.B. Add the following new subparagraph to Paragraph 15.03.B:

1. If some or all of the Work has been determined not to be at a point of Substantial Completion and will require re-inspection or re-testing by Engineer, the cost of such re-inspection or re-testing, including the cost of time, travel and living expenses, will be paid by Contractor to Owner. If Contractor does not pay, or the parties are unable to agree as to the amount owed, then Owner may impose a reasonable set-off against payments due under this Article 15.

15.06 Final Payment

SC-15.06 Add the following Paragraph 15.06.A.4. Immediately following Paragraph 15.06.A.3.

4. Final payment will not be made to the CONTRACTOR until a certificate showing that the CONTRACTOR has complied with the provisions of M.S.A. 290.92 requiring withholding of income tax on wages at the source. Said certificate shall be executed by the Commissioner of Revenue. Forms for certification may be obtained from the Commissioner of Revenue, Centennial Building, St. Paul, Minnesota 55145.

15.08 Correction Period

SC-15.08 Add the following new Paragraph 15.08.G:

- G. The correction period specified as one year after the date of Substantial Completion in Paragraph 15.08.A of the General Conditions is hereby revised to be the number of years set forth in SC-6.01.B.1; or if no such revision has been made in SC-6.01.B, then the correction period is hereby specified to be 2 years after Substantial Completion.

#### **ARTICLE 16—SUSPENSION OF WORK AND TERMINATION**

No Supplementary Conditions in this Article.

#### **ARTICLE 17—FINAL RESOLUTIONS OF DISPUTES**

No Supplementary Conditions in this Article.

#### **ARTICLE 18—MISCELLANEOUS**

No Supplementary Conditions in this Article.

**EXHIBIT A —SOFTWARE REQUIREMENTS FOR ELECTRONIC DOCUMENT EXCHANGE**

Item	Electronic Documents	Transmittal Means	Data Format	Note (1)
a.1	General communications, transmittal covers, meeting notices and responses to general information requests for which there is no specific prescribed form.	Email	Email	
a.2	Meeting agendas, meeting minutes, RFI's and responses to RFI's, and Contract forms.	Email w/ Attachment	PDF	(2)
a.3	Contractor's Submittals (Shop Drawings, "or equal" requests, substitution requests, documentation accompanying Sample submittals and other submittals) to Owner and Engineer, and Owner's and Engineer's responses to Contractor's Submittals, Shop Drawings, correspondence, and Applications for Payment.	Email w/ Attachment	PDF	
a.4	Correspondence; milestone and final version Submittals of reports, layouts, Drawings, maps, calculations and spreadsheets, Specifications, Drawings and other Submittals from Contractor to Owner or Engineer and for responses from Engineer and Owner to Contractor regarding Submittals.	Email w/ Attachment or LFE	PDF	
a.5	Layouts and drawings to be submitted to Owner for future use and modification.	Email w/ Attachment or LFE	DWG	
a.6	Correspondence, reports, and Specifications to be submitted to Owner for future word processing use and modification.	Email w/ Attachment or LFE	DOC	
a.7	Spreadsheets and data to be submitted to Owner for future data processing use and modification.	Email w/ Attachment or LFE	EXC	
a.8	Database files and data to be submitted to Owner for future data processing use and modification.	Email w/ Attachment or LFE	DB	
<b>Notes</b>				
(1)	All exchanges and uses of transmitted data are subject to the appropriate provisions of Contract Documents.			
(2)	Transmittal of written notices is governed by Paragraph 18.01 of the General Conditions.			
<b>Key</b>				
Email	Standard Email formats (.htm, .rtf, or .txt). Do not use stationery formatting or other features that impair legibility of content on screen or in printed copies			
LFE	Agreed upon Large File Exchange method (FTP, CD, DVD, hard drive)			
PDF	Portable Document Format readable by Adobe® Acrobat Reader Version.			
DWG	Autodesk® AutoCAD .dwg format Version.			
DOC	Microsoft® Word .docx format Version.			
EXC	Microsoft® Excel .xls or .xml format Version.			
DB	Microsoft® Access .mdb format Version.			

This document is a MODIFIED version of EJCDC® C-800 Exhibit A, Copyright© 2018 by NSPE, ACEC, and ASCE. All rights reserved.



CONDITIONS OF THE CONTRACT

for

Vernon Avenue Improvements

OT1.129866

Lower Minnesota River Watershed District

Savage, MN



**FIELD ORDER FORM**

**NO.:** \_\_\_\_\_

Owner:	Lower Minnesota River Watershed	Owner's Project No.:	
Engineer:	District	Engineer's Project No.:	OT1.129866
Contractor:		Contractor's Project No.:	
Project:	Vernon Avenue Improvements		
Contract Name:			
Date Issued:		Effective Date of Field Order:	

Contractor is hereby directed to promptly perform the Work described in this Field Order, issued in accordance with Paragraph 11.04 of the General Conditions, for minor changes in the Work without changes in Contract Price or Contract Times. If Contractor considers that a change in Contract Price or Contract Times is required, submit a Change Proposal before proceeding with this Work.

**Reference:**

Specification Section(s):  
Drawing(s) / Details (s):

**Description:**

**[Description of the change to the Work]**

**Attachments:**

**[List documents supporting change]**

**Issued by Engineer**

By: \_\_\_\_\_  
Title: \_\_\_\_\_  
Date: \_\_\_\_\_

This document is a MODIFIED version of EJDCDC® C-942, Copyright© 2018 by NSPE, ACEC, and ASCE. All rights reserved.

**WORK CHANGE DIRECTIVE FORM**

**NO.:** \_\_\_\_\_

Owner:

Owner's Project No.:

Engineer:

Engineer's Project No.:

Contractor:

Contractor's Project No.:

Project:

Contract Name:

Effective Date of Work Change

Date Issued:

Directive:

Contractor is directed to proceed promptly with the following change(s):

Description:

**[Description of the change to the Work]**

Attachments:

**[List documents related to the change to the Work]**

Purpose for the Work Change Directive:

**[Describe the purpose for the change to the Work]**

Directive to proceed promptly with the Work described herein, prior to agreeing to change in Contract Price and Contract Time, is issued due to:

**Notes to User—Check one or both of the following**

Non-agreement on pricing of proposed change.  Necessity to proceed for schedule or other reasons.

Estimated Change in Contract Price and Contract Times (non-binding, preliminary):

Contract Price: \$ \_\_\_\_\_ **[increase] [decrease] [not yet estimated].**

Contract Time: \_\_\_\_\_ days **[increase] [decrease] [not yet estimated].**

Basis of estimated change in Contract Price:

Lump Sum  Unit Price  Cost of the Work  Other

Recommended by Engineer

Authorized by Owner

By: \_\_\_\_\_

Title: \_\_\_\_\_

Date: \_\_\_\_\_

This document is a MODIFIED version of EJCDC® C-941, Copyright© 2018 by NSPE, ACEC, and ASCE. All rights reserved.



**CHANGE ORDER FORM**

**NO.:** \_\_\_\_\_

Owner: Lower Minnesota River Watershed  
 District  
 Engineer: \_\_\_\_\_  
 Contractor: \_\_\_\_\_  
 Project: Vernon Avenue Improvements  
 Contract Name: \_\_\_\_\_  
 Date Issued: \_\_\_\_\_

Owner's Project No.: \_\_\_\_\_  
 Engineer's Project No.: OT1.129866  
 Contractor's Project No.: \_\_\_\_\_  
 Effective Date of Change Order: \_\_\_\_\_

The Contract is modified as follows upon execution of this Change Order:

Description:

**[Description of the change]**

Attachments:

**[List documents related to the change]**

Change in Contract Price	Change in Contract Times [State Contract Times as either a specific date or a number of days]
Original Contract Price: \$ _____	Original Contract Times: Substantial Completion: _____ Ready for final payment: _____
<b>[Increase] [Decrease]</b> from previously approved Change Orders No. 1 to No. <b>[Number of previous Change Order]</b> : \$ _____	<b>[Increase] [Decrease]</b> from previously approved Change Orders No.1 to No. <b>[Number of previousChange Order]</b> : Substantial Completion: _____ Ready for final payment: _____
Contract Price prior to this Change Order: \$ _____	Contract Times prior to this Change Order: Substantial Completion: _____ Ready for final payment: _____
<b>[Increase] [Decrease]</b> this Change Order: \$ _____	<b>[Increase] [Decrease]</b> this Change Order: Substantial Completion: _____ Ready for final payment: _____
Contract Price incorporating this Change Order: \$ _____	Contract Times with all approved Change Orders: Substantial Completion: _____ Ready for final payment: _____

Recommended by Engineer (if required)

Accepted by Contractor

By: \_\_\_\_\_

\_\_\_\_\_

Title: \_\_\_\_\_

\_\_\_\_\_

Date: \_\_\_\_\_

\_\_\_\_\_

Authorized by Owner

Approved by Funding Agency (if applicable)

By: \_\_\_\_\_

\_\_\_\_\_

Title: \_\_\_\_\_

\_\_\_\_\_

Date: \_\_\_\_\_

\_\_\_\_\_

This document is a MODIFIED version of EJCDC® C-941, Copyright© 2018 by NSPE, ACEC, and ASCE. All rights reserved.

# CERTIFICATE OF SUBSTANTIAL COMPLETION

Owner: \_\_\_\_\_ Owner's Project No.: \_\_\_\_\_  
Engineer: \_\_\_\_\_ Engineer's Project No.: \_\_\_\_\_  
Contractor: \_\_\_\_\_ Contractor's Project No.: \_\_\_\_\_  
Project: \_\_\_\_\_  
Contract Name: \_\_\_\_\_

This  Preliminary  Final Certificate of Substantial Completion applies to:

All Work  The following specified portions of the Work:

[Describe the portion of the work for which Certificate of Substantial Completion is issued]

Date of Substantial Completion: [Enter date, as determined by Engineer]

The Work to which this Certificate applies has been inspected by authorized representatives of Owner, Contractor, and Engineer, and found to be substantially complete. The Date of Substantial Completion of the Work or portion thereof designated above is hereby established, subject to the provisions of the Contract pertaining to Substantial Completion. The date of Substantial Completion in the final Certificate of Substantial Completion marks the commencement of the contractual correction period and applicable warranties required by the Contract.

A punch list of items to be completed or corrected is attached to this Certificate. This list may not be all-inclusive, and the failure to include any items on such list does not alter the responsibility of the Contractor to complete all Work in accordance with the Contract Documents.

Amendments of contractual responsibilities recorded in this Certificate should be the product of mutual agreement of Owner and Contractor; see Paragraph 15.03.D of the General Conditions.

The responsibilities between Owner and Contractor for security, operation, safety, maintenance, heat, utilities, insurance, and warranties upon Owner's use or occupancy of the Work must be as provided in the Contract, except as amended as follows:

Amendments to Owner's Responsibilities:  None  As follows:

[List amendments to Owner's Responsibilities]

Amendments to Contractor's Responsibilities:  None  As follows:

[List amendments to Contractor's Responsibilities]

The following documents are attached to and made a part of this Certificate:

[List attachments such as punch list; other documents]

This Certificate does not constitute an acceptance of Work not in accordance with the Contract Documents, nor is it a release of Contractor's obligation to complete the Work in accordance with the Contract Documents.

Engineer

By (signature): \_\_\_\_\_

Name (printed): \_\_\_\_\_

Title: \_\_\_\_\_

This document is a MODIFIED version of EJCDC® C-625, Copyright© 2018 by NSPE, ACEC, and ASCE. All rights reserved.

## SECTION 01 11 00 - SUMMARY OF WORK

### PART 1 - GENERAL

#### 1.1 PROJECT LOCATION

- A. The project location is shown on the vicinity map in the design drawing set.

#### 1.2 PROJECT DESCRIPTION

- A. The project involves but is not limited to the complete construction of public improvements for the reconstruction of street(s). Individual elements of work shall include, but are not limited to:
1. Removal of bituminous pavement, pipe and other miscellaneous items.
  2. Clearing and grubbing.
  3. Street excavation.
  4. Storm sewer construction.
  5. Bituminous street construction.
  6. Turf restoration and erosion control construction.
  7. Traffic Control.
  8. Other miscellaneous work shown on the plans or specified herein.

#### 1.3 ALTERNATE MATERIALS & METHODS OF CONSTRUCTION

- A. The Contractor may present alternative materials and/or methods of construction for consideration by the Owner. Proposals for such alternatives shall be in accordance with the provisions of Section 01 23 00 "Alternates" of this Project Manual.

#### 1.4 CONTRACTOR USE OF PROJECT SITE

- A. The Contractor's use of the project site shall be limited to its construction operations, including on-site storage of materials and field offices. No materials shall be stored in a location as to limit access to the affected public. Any damage caused by Contractor operations to private property, including but not limited to, parking lots, trees, shrubs, material spatter, etc. shall promptly be corrected at the Contractor's expense.

### PART 2 - PRODUCTS (NOT USED)

### PART 3 - EXECUTION

#### 3.1 OPERATIONAL LIMITATIONS AND REQUIREMENTS

- A. The Contractor shall confine its work within the limits of the easements, public rights-of-way, and/or construction limits as shown on the plans. If the Contractor desires additional space, it shall be the Contractor's responsibility to acquire easements and/or permission, as desired.

#### 3.2 BARRICADES

- A. The Contractor shall furnish and install any necessary barricades to protect the public or workers during the project. Barricades to keep public out of construction areas shall be left in place until removed by Contractor after they are no longer required for protection. The Contractor is responsible to secure the site at all times during the demolition.
- B. The Contractor shall furnish names, addresses, and phone numbers of at least two local individuals capable of immediate response who will be responsible for the site security and traffic control devices to:

The Engineer  
The Owner  
Local Law Enforcement Agencies

- C. The Contractor shall respond with sufficient personnel, equipment and/or materials and conduct the required work or be subject to a **\$100 per hour deduction from the time of notification for non-attention to project security and safety.**

3.3 SAFETY HAZARDS

- A. The Owner, Engineer or their representatives may indicate potential safety hazards noticed at the Construction site. However, the Contractor shall remain the only party liable for the maintenance of safe construction practices.

3.4 INTERFERENCE WITH TREES

- A. The Contractor may be required to trim tree branches that overhang the work zone as specifically identified during construction by the Engineer, where branches are likely to be broken or excessively damaged by construction equipment and activities. Branches which are accidentally damaged during construction shall be trimmed immediately. All trimmed ends shall be coated with an appropriate coating material.
- B. The Contractor shall protect existing trees within close proximity of the construction from stripping and root damage. Roots extending into excavations shall be cut before excavating in their vicinity. Roots cut or otherwise damaged shall be coated with an appropriate protective dressing prior to backfilling.
- C. No direct compensation for tree protection and interference shall be made, unless specifically identified in the Schedule of Unit Prices.

**\*\*\*\*END OF SECTION\*\*\*\***

## SECTION 01 23 00 - ALTERNATES

### PART 1 - GENERAL

#### 1.1 SUMMARY

- A. This section shall govern the interpretation and evaluation of bid alternates and contractor proposed alternatives.
- B. The Owner reserves the right to reject any bids not complying with the requirements of this section.
- C. All bids must include a bid based on the "base bid" or the Contract Documents defined alternatives, as specified, without anticipation of the use of "or equal" items or contractor proposed alternatives. Bids solely based on the use of "or equal" items or contractor proposed alternatives may be rejected without consideration, at the discretion of the Owner.
- D. Qualification process
  - 1. Installers wishing to qualify alternate methods and/or materials for this project must submit a copy of the license or certificate verifying the manufacturer's or licensor's approval, and evidence of the installer's experience including the number, total length, and locations of trenchless construction projects installed to date using the proposed materials and methods together with the names and phone numbers of facility owners to the Engineer 10 days prior to the opening of bids to allow time for evaluation.
  - 2. The final decision to accept or reject the applicant lies solely with the Owner.

#### 1.2 INTERPRETATION OF "OR EQUAL" CLAUSES

- A. The Contractor shall include in its base bid the items, as specified, without consideration of using the 'or equal' items and methods.
- B. The Contractor shall then include in its bid the amount of the deduction, increase or revised total bid to be applied if the 'or equal' items and methods are accepted.
- C. The Owner and Engineer shall evaluate the 'or equal' stature of the proposed materials and methods.
- D. The Owner reserves the right to accept or reject the proposed 'or equal' materials and methods at the appropriate adjustment to bid price.

#### 1.3 PROPOSALS WITH SPECIFIED BID ALTERNATES

- A. The Owner reserves the right to select the bid alternate desired, regardless of the amount bid.
- B. The bid shall be awarded to the lowest and best bidder of the selected alternate.

#### 1.4 CONTRACTOR PROPOSED ALTERNATIVES

- A. Contractor proposed alternative methods and techniques may be considered by the Owner, with the advice of the Engineer, after Award of Contract. No alternatives shall be accepted or considered as part of the bid.
- B. The Contractor shall include in its base bid the items, as specified, without consideration of using any proposed alternative materials and/or methods.
- C. The Contractor shall then include in its bid the amount of the deduction, increase or revised bid amount to be applied if the proposed alternative materials and methods are accepted.
- D. The Owner and Engineer shall evaluate the stature of the proposed materials and methods.
  - 1. Evaluation by the Owner and Engineer shall include the cost of modifying the design, as necessary and shall be at the discretion of the Owner and Engineer.

2. If the Contractor is proposing trenchless technology that is not included as a contract alternative, the following modifications to the original design shall be anticipated by the Contractor and included in the price differential or revised contract amount, as proposed:
    - (a) The actual inside pipe diameter included in the Contractor proposed alternative shall be equal to or larger than the original conduit design, as specified, unless approved by the Engineer.
    - (b) The minimum grade of all conduits installed by trenchless technologies for gravity sewers shall be 0.80 percent. This minimum may increase the depth required for structures. The Contractor shall include in the price differential or revised contract amount the cost of any such increases in structure depth.
    - (c) Proposed modifications which include changes in pipe size whether to meet the required actual inside pipe diameter or necessitated by proposed changes in pipe materials, etc. may require changes in manhole diameters to accommodate the necessary pipe entrances. The Contractor shall include in the price differential or revised contract amount the cost of any such increases in manhole size.
- E. The Owner reserves the right to accept or reject "Contractor Proposed Alternatives".

#### 1.5 SPECIFICATION REFERENCES

- A. If the Bidder proposes an alternative:
1. The Bidder is required to request, in writing, a determination on the Specifications which will be enforced to govern the construction. This request shall be made directly to the Engineer at the time of bid opening or before.
  2. The Engineer shall provide a written response prior to the end of the next working day to allow the Contractor time to withdraw its bid, if requested by the Contractor.

#### 1.6 SUBMITTALS

- A. "OR EQUAL" MATERIALS AND/OR METHODS
1. Unless otherwise specified, Contractors whose bids are based on "equal" materials and/or methods shall include with their bid the manufacturer name, address, product name, model, specification reference and/or testing certification of the items proposed to be used. The Contractor shall also include evidence of the 'equal' stature of the products proposed.
- B. PROPOSALS FOR SPECIFIED BID ALTERNATES
1. Unless otherwise specifically requested, no submittals are required.
  2. Unless otherwise specifically requested, the Contractor is required to bid at least one of the alternates included in the proposal form, and the Contractor may choose to bid other alternates or not.
- C. CONTRACTOR PROPOSED ALTERNATIVES
1. The Contractor shall contact the Engineer prior to bidding the job to discuss its proposed alternative approach to the methods and materials used or execution of the job. The Engineer shall evaluate the proposed methods and may at the Engineer's discretion choose to issue an addendum to all contractors or accept the conversation as privileged communication.
  2. Unless otherwise specified, the Contractors whose bid includes alternative materials and/or methods shall include with their bid the manufacturer name, address, product name, model, specification reference and/or testing certification of the items proposed to be used. The Contractor shall also include evidence of the 'equal' stature of the products and/or methods proposed.
  3. The Contractor shall mark the outside of the bid envelope that alternative methods are included.

### **PART 2 - PRODUCTS (NOT USED)**

**PART 3 - EXECUTION (NOT USED)**

**\*\*\*\*END OF SECTION\*\*\*\***





## SECTION 01 29 00 - PAYMENT PROCEDURES

### PART 1 - GENERAL

#### 1.1 SUMMARY

- A. Methods of measurement and payment for all items not individually specified shall be according to the appropriate referenced specification standard.

#### 1.2 MEASUREMENT & PAYMENT

- A. **Payment for Plan Quantity (P) Items:** Items designated as Plan Quantity (P) shall be measured and paid for based on the quantity listed in the plans and no field measurement shall be made. The Engineer will only adjust the quantities on Plan Quantity (P) designated Contract items when the Engineer authorizes changes to the dimensions of that work (in which case only the affected portion will be re-determined) or when the Engineer determines that the quantity designated as a Plan Quantity (P) is incorrect.
- B. **Payment for Hauled Materials:** No compensation will be paid for any weigh ticket received after the date shown on the ticket unless prior arrangements are made with the Engineer.
- C. **Payment for Major Lump Sum Items:** The Contractor shall submit a schedule of values for major items of construction that are bid as Lump Sum. The schedule shall identify major sections of work and the percentage of the bid price applied to each. Payment shall be made according to the percentage complete of each major section of work.

#### 1.3 SUBMITTALS

- A. The Contractor shall submit a schedule of values for major items of construction that are bid as Lump Sum.
- B. The Contractor shall submit to the Engineer a "Certificate of Conformance" statement stating that the scale used to weigh hauled materials has been tested and calibrated for the current construction season. This Certificate shall be from MnDOT or other reliable scale servicing company. Providing a certified scale and obtaining such "Certificate of Conformance" is the sole responsibility of the Contractor and all costs associated are considered incidental to the materials being supplied.
- C. **Hauled Materials:** The Contractor shall furnish numbered weigh tickets which list the Date, Project, Type of Material, Gross Weight, Tare Weight, Material Weight in tons, and Truck Number for each load brought to the construction site. If the individual pay items are identified on a unit weight basis, the Contractor shall provide the Engineer with a summary type spreadsheet which provides accumulative job totals of all aggregate and bituminous materials hauled to the project. This spreadsheet shall be submitted to the Engineer on a weekly basis.
- D. **Procured Materials:** The Contractor shall furnish an insurance bond showing the type of material, the amount of material, the valuation of the material, the stored location, the project, the date, the name, and address of the surety.
- E. **Compacted Volume Materials:** When measurement is specified by the CUBIC YARD, (CY) COMPACTED VOLUME (CV), will be determined by length, width and depth measurements of the material in its placed and compacted position, according to the placement dimensions as shown in the Contract or as designated by the Engineer.

### PART 2 - PRODUCTS (NOT USED)

### PART 3 - EXECUTION (NOT USED)

\*\*\*\*\*END OF SECTION\*\*\*\*\*



## SECTION 01 31 00 – PROJECT MANAGEMENT AND COORDINATION

### PART 1 - GENERAL

#### 1.1 SEQUENCE OF CONSTRUCTION

- A. A written project management scheduling tool (i.e., critical path (CPM), detailed bar chart, etc.) shall be employed by the Contractor for cost value reporting, planning, and scheduling of all work required under the Contract Documents. This schedule shall show the order in which the Contractor proposes to execute the work with dates on which it proposes to start the various phases of the work and the estimated completion date of each phase. The Contractor shall submit a preliminary version of its intended schedule within 10 working days following the *Notice of Award* on the attached form or a form of its own choosing. **The Contractor is required to show the initial critical path (CPM) of tasks to be performed.**
- B. Unless otherwise approved by the Engineer, the schedule shall also include an anticipated payment schedule for the volume of work to be completed each month. This schedule shall indicate the Contractor's intention and ability to complete the work within the contract times, as specified in Article 4 of Section 00 52 00 "Agreement Forms" of this Project Manual.
- C. The Preconstruction Conference as outlined in Section 01 31 19 "Project Meetings" of this Project Manual will not be conducted until the schedule is submitted. In addition, no construction staking shall be provided until the schedule is submitted by the Contractor and reviewed by the Engineer.

#### 1.2 WORKING HOURS

- A. Except in connection with safety or emergencies, all work at the site shall be performed during normal working hours as defined in the Supplementary Conditions.
- B. The Contractor shall notify the Owner and Engineer of any work planned on Saturday, Sunday, or any legal holidays at least 48 hours prior to such work.
- C. The Contractor shall coordinate any construction or hauling activity in the vicinity of churches, schools, medical facilities, and funeral homes. The Contractor shall be cognizant of the disruptive effects of continued construction during funerals. The Owner reserves the right to temporarily stop construction within one block of, and during the time of, any funeral procession. No compensation shall be granted to the Contractor due to temporary delays caused by funerals.

#### 1.3 TRAFFIC CONTROL

- A. Reference Section 01 55 26 "Traffic Control" of this Project Manual.

#### 1.4 COORDINATION WITH BUSINESSES AND PRIVATE PROPERTY OWNERS ADJACENT TO THE PROJECT

- A. The Contractor shall notify all property owners and occupants adjacent to the project 2 days in advance to allow moving machinery and/or vehicles or other items that may be blocked in or damaged due to the upcoming construction in the area. Access to the properties shall be restored as soon as possible after each phase of construction.

#### 1.5 COORDINATION WITH UTILITY COMPANIES

- A. The Contractor is responsible for working with public and private utility companies in protecting and/or relocating existing or new utility lines located near and affected by this construction.
  - 1. Coordination with the utility companies is very important and should be considered in planning the work and the associated extra costs involved.
  - 2. Private utility companies are responsible for their own lines and are so obligated under City Code Agreements to protect and/or relocate their utilities if required to install new City-owned utilities in a given area.

- B. The Contractor shall consult with the City’s maintenance personnel when working around or performing the required sanitary sewer installations.
- C. The Contractor shall also work with the City’s maintenance personnel to provide for scheduled water shut downs in a given area and to provide for continued water service to the properties along the project throughout the duration of the project.
- D. The Contractor shall work with all utility companies, as necessary, to allow for installation and maintenance of service of gas, power, lighting, telephone, cable TV, etc. in the boulevards or across the streets prior to final shaping of aggregate base and/or topsoil. This coordination with the utility companies is the responsibility of the Contractor and is considered incidental to the construction and no additional compensation shall be granted.
  - 1. **AT&T has approved plans to complete improvements to their fiber utility line along Vernon Avenue, currently scheduled for the spring/summer of 2024. Schedule coordination with AT&T’s contractor may be necessary for the orderly completion of the construction project(s).**
- E. **The Contractor shall coordinate their proposed construction schedule with LS Marine to ensure there is no conflict in schedules for planned dredge hauling operations. The proposed construction schedule must be submitted to the Engineer for approval, including the required coordination with LS Marine’s operations.**
  - 1. LS Marine operates the dredge site at the north end of Vernon Avenue and hauls dredge material off site at varying times throughout the year. Vernon Avenue is the only access to this site meaning that the proposed construction work will temporarily eliminate access. LS Marine does not have a set schedule of dates to complete the work, but have historically targeted May or June to complete hauling operations that typically take one to two weeks to complete.
  - 2. LS Marine Contact:
    - (a) Name: Taylor Luke
    - (b) Email: taylorl@lsmarine.com
    - (c) Main Phone: 651-653-6307
    - (d) Cell Phone: 612-554-9764
    - (e) [Marine Construction Company | Pile Driving | Channel Dredging \(lsmarine.com\)](https://www.lsmarine.com)

1.6 COOPERATION WITH FIRE & EMERGENCY DEPARTMENTS

- A. The Contractor shall coordinate all work requiring shutting down water service or limiting access to buildings by emergency equipment with the fire & emergency departments. This shall include notification of the daily construction schedule by the Contractor.

1.7 COOPERATION WITH OTHER CONTRACTORS

- A. The Contractor shall cooperate with other contractors performing construction on other projects in the vicinity of this project, including but not limited to allowing access for the delivery of equipment and materials.

1.8 COORDINATION WITH SERVICE PROVIDERS

- A. The Contractor shall coordinate with the postal service, recycling service, garbage collection service, school bus service, etc. to maintain continuous uninterrupted service to all residences and businesses throughout the duration of the project.
- B. The Contractor shall temporarily relocate mailboxes, haul recycling and garbage for residents to a designated pick-up location, etc., as required by the subject service provider. All equipment materials and labor required to coordinate with service providers and maintain services shall be incidental to the Contract.

1.9 SUBMITTALS

- A. Written Progress Management Schedule Tool- to be reviewed at the Preconstruction Conference. Notice to proceed will not be issued until a schedule is submitted to the Engineer. See Article 4 of Section 00 52 00 "Agreement Forms" of this Project Manual for contractual time requirements.

**PART 2 - PRODUCTS (NOT USED)**

**PART 3 - EXECUTION (NOT USED)**

**\*\*\*\*END OF SECTION\*\*\*\***



## SECTION 01 31 19 - PROJECT MEETINGS

### PART 1 - GENERAL

#### 1.1 SUMMARY

##### A. Pre-construction Conference

1. Prior to the start of the work, a joint meeting will be held with representatives of the Contractor, the Owner, the Engineer, and any other interested parties. This meeting is intended to introduce the various key personnel from each organization and to discuss the start of the work, order of work, labor and legal requirements, insurance requirements, method of payment, shop drawing requirements, protection of existing facilities, location of disposal and stockpile areas, and other pertinent items associated with the project.
2. The Contractor shall be prepared to discuss his proposed detailed construction progress schedule. The construction schedule shall be subject to the review of the Owner, Engineer and applicable agencies.

##### B. Construction Progress Meetings

1. These meetings will require the attendance of the Contractor's Project Manager or other designated staff authorized by the Contractor to discuss project status and negotiate agreements between the Contractor and Owner. Failure of the Contractor to attend scheduled project meetings as required may result in project delays expensed by the Contractor.
2. Meetings will be held between the Owner, Contractor and Engineer for the purpose of reviewing the project schedule or the status of the project. These meetings will be arranged by the Owner, and/or Engineer, as deemed necessary.

##### C. Safety Meetings

1. The Owner, Engineer or their representatives shall be allowed to attend Contractor's onsite safety meetings. The Contractor shall be responsible for meeting content and coordination and shall inform the Owner, Engineer or their representatives of the time and location of the meeting a minimum of two business days prior to the meeting.
2. The Contractor shall make additional copies of any safety related handouts or materials for distribution to the Owner, Engineer or their representatives. However, the Contractor shall remain the only party responsible for the maintenance of project safety materials.

### PART 2 - PRODUCTS (NOT USED)

### PART 3 - EXECUTION (NOT USED)

\*\*\*\*END OF SECTION\*\*\*\*





## SECTION 01 33 00 – SUBMITTAL PROCEDURES

### PART 1 - GENERAL

#### 1.1 SUMMARY

- A. The Contractor shall submit all required submittals and sample items as noted below. The Engineer will review them with reasonable promptness. The Contractor shall make all required corrections and file with the Engineer three corrected sets for final review.
- B. Additional submittals are required in the technical specifications. The responsibility for completeness of submittals lies with the Contractor.
- C. If the Engineer and/or Owner sign the submittal with no exception taken, such action shall not absolve the responsibilities of the Contractor in any way.
- D. Emailed submittals to the Engineer in pdf format will be accepted.

#### 1.2 ITEMS TO BE SUBMITTED

- A. Written Progress Management Schedule Tool - to be reviewed at the Preconstruction Conference. See Article 4 of Section 00 52 00 "Agreement Forms" of this Project Manual for contractual time requirements.
- B. Minnesota Pollution Control Agency (MPCA) - General Storm Water Permit for Construction Activity (MN R100001) – Reference Section 01 57 13 "Temporary Erosion & Sediment Control" of this Project Manual.
- C. Bituminous Mix Design (wear and non-wear)
- D. Gradation Test Results from 2 separate tests, as required in Source Quality Control provisions of individual sections contained herein, from material stockpiles of aggregates to be used on this project. These tests may be run by the Contractor or its supplier during aggregate production.
- E. Storm Sewer, Subdrain, and Sump Drain Lines
  - 1. Piping and fittings - Certificates of Compliance.
- F. Seeding - Certificates of Compliance for seed mixture.

#### 1.3 MATERIAL SAFETY DATA SHEETS

- A. The Contractor shall submit two copies of Safety Data Sheets (SDSs) (formerly known as Material Safety Data Sheets or MSDSs) for each material on-site to the Owner.
- B. The Contractor shall maintain an orderly file of Safety Data Sheets at the job site.

#### 1.4 RECORD DRAWINGS

- A. The Contractor shall maintain at the construction site one complete set of drawings suitably marked to show all deviations from the original set of drawings and other information as specified. Supplementary sketches shall be included, if necessary, to clearly indicate all work as constructed. Sanitary and water service tie-in or stub-out locations shall show station and distances left or right of the survey control centerline. Existing sanitary and water service piping material type and size at the tie-in locations shall be noted also.
- B. All manholes, watermain bends, and valves shall be located with tie-off dimensions to known items on the plans or in the field to enable the Contractor or City personnel to locate these structures for adjustment.
- C. The Contractor shall fill out a service record form for each water service and sanitary sewer service connection or stub out. A blank service record form will be supplied by the Engineer to be used by the Contractor. The completed service record forms and photos taken of the services shall be submitted to the Engineer in a digital format and in booklet form.

- D. All work shall be clearly shown, and the record drawings and service record forms shall be satisfactory to the Owner to ensure that adequate information is indicated to show the actual construction. The complete set of the record drawings shall be submitted to the Engineer prior to the submittal of the final Application for Payment. Failure of the Contractor to maintain an up-to-date set of record drawings on the project site shall be a reason to withhold payments. All underground lines shall be determined from the record drawings.

#### 1.5 CONSTRUCTION PHOTOS

- A. The Contractor shall take digital photos during the course of construction using only cameras or smartphones with Global Positioning System (GPS) capabilities. GPS location settings shall be turned on at the time of taking each photo. The quality of the photos submitted shall be sufficient to clearly depict the focal points in the photo.
- B. The Contractor shall take photos of underground construction work prior to backfilling. Such items to be photographed include but are not limited to: connections to existing utilities, watermain fittings, small/private underground utilities, utility stub-outs, manholes, etc.
- C. The Contractor shall take photos of all water service and sanitary sewer service connections at the main and at the tie-in or stub-out locations prior to backfilling the service. The photo shall indicate the house address number or lot description of the service location.
- D. After the first couple of days of underground construction, the Contractor shall submit to the Engineer a sample set of digital photos. The test set of photos will be reviewed to verify that the date, GPS coordinates, and other photo features are being recorded.
- E. All photos shall be submitted to the Engineer in a digital format immediately upon completion of the utility installation. The digital properties of the photos, such as date and time taken and GPS coordinates, shall be full intact at the time of submittal. Failure of the Contractor to maintain a set of construction photos shall be reason to withhold payments.

#### **PART 2 - PRODUCTS (NOT USED)**

#### **PART 3 - EXECUTION**

##### 3.1 SUBMITTAL ROUTING

- A. Submittals shall be submitted via email or digital transfer method acceptable to the Engineer.
- B. Acceptable File Formats
  - 1. Reports: Searchable PDF
  - 2. Shop Drawings and Material Certifications: PDF
  - 3. Photos: JPG with GPS location
  - 4. Video: MP4 or WAV with both audio and video

##### 3.2 SAMPLES

- A. Samples shall be delivered to the address specified in the Specification Section.

##### 3.3 PHOTOS

- A. Photos shall be taken using a device with the Global Positioning System (GPS) setting enabled.
- B. The quality of the photos submitted shall be sufficient to clearly depict the focal points in the photo.

##### 3.4 RESPONSIBILITY

- A. The Contractor shall allow a minimum of 5-business days for Engineer review unless otherwise agreed by the Engineer.

- B. Where review is required by a regulatory agency or permitting agency that is not the Owner, the Contractor shall allow additional time in the schedule to accommodate the agency review.
- C. All submittals shall be reviewed by the Engineer prior to their incorporation into the project. If materials are installed without prior review, they will be subject to removal, at the Contractor's expense, if the material is found to be non-conforming to the Specifications.
- D. Time delays or costs incurred by the Contractor due to late submittals by the Contractor shall not be acceptable cause for claims by the Contractor.
- E. Failure of the Contractor to make submittals may be cause to withhold payment until submittals are received.

**\*\*\*\* END OF SECTION \*\*\*\***



## SECTION 01 41 00 - REGULATORY REQUIREMENTS

### PART 1 - GENERAL

#### 1.1 SUMMARY

- A. Applicable codes and standards referred to in these specifications shall establish minimum requirements and shall be superseded by more stringent requirements of drawings and specifications when and where they occur.
- B. Any conflicts between specifications and applicable codes and standards shall be referred to the Engineer.

#### 1.1 SUBMITTALS

- A. The Contractor shall submit copies of Safety Data Sheets (SDSs) for each material on site to the Engineer.

### PART 2 - PRODUCTS

#### 2.1 EQUIPMENT

- A. All equipment furnished and installed under the contract shall be designed, fabricated, assembled, installed, and placed into service. The equipment will conform to the applicable provisions of the Federal and State Safety and Health Standards, including but not limited to Federal Occupational Safety and Health Regulations for Construction; the Division of Environmental Health, Minnesota Department of Health; the Minnesota Pollution Control Agency; the Department of Natural Resources; the Minnesota Department of Transportation, Division of Highways; the Minnesota Industrial Commission and ordinances of the City that apply to this work.

### PART 3 - EXECUTION

#### 3.1 CONSTRUCTION

- A. All construction methods and tools shall comply with commonly accepted standards for safety and health of personnel engaged on construction, including but not limited to Federal Occupational Safety and Health Regulations for Construction; the Division of Environmental Health, Minnesota Department of Health; the Minnesota Pollution Control Agency; the Department of Natural Resources; the Minnesota Department of Transportation, Division of Highways; the Minnesota Industrial Commission and ordinances of the City that apply to this work.

\*\*\*\*END OF SECTION\*\*\*\*



## SECTION 01 41 26 - PERMIT REQUIREMENTS

### PART 4 - GENERAL

#### 1.1 SUMMARY

- A. Any conflicts between specifications and permits for this project shall be referred to the Engineer.

#### 1.2 PERMITS OBTAINED BY OWNER

- A. The Owner has applied for the following permits from appropriate authorities. It is anticipated that permission to proceed will be authorized prior to execution of Contract. The Contractor shall perform all work and conduct itself in full accordance with the requirements of the applicable permit:
1. Minnesota Pollution Control Agency (MPCA) - General Storm Water Permit for Construction Activity (MN R100001).
  2. Work within the City of Savage right-of-way.
  3. Work within the Union Pacific railroad right-of-way.
    - (a) Maintenance Consent Letter
- B. The Contractor shall be responsible for meeting any administrative fees, bonding, insurance requirements, etc. which may be required as a condition to any permit, listed above.
1. **Contractor shall familiarize themselves with the requirements of the Work within Union Pacific Railroad right-of-way permit, including the required administrative fee, insurance, training, notifications, and submittals.** These requirements are detailed further under Section 1.5 (Work Within a Railroad Right of Way), below.

#### 1.3 PERMITS OBTAINED BY CONTRACTOR

- A. The Contractor shall secure and pay the cost of any other permits not mentioned above, which may be required for work within the project limits including but not limited to:
1. None.
- B. The Contractor shall identify, secure, and pay for any required permission, fee, or permit for work not within the project limits, but which may be considered a connected action. A connected action shall be defined as including but not limited to:
1. Obtaining borrow for the project,
  2. Disposal of any waste product or excess material resulting from the project, and
  3. Any action by the Contractor that is closely related by proximity in location and time to the project that may be perceived by the public or any regulatory body to be part of the project.

#### 1.4 SUBMITTALS

- A. Contractor shall provide a draft copy of all notifications, submittals, and permit applications to the Engineer for review a minimum of 5-business days prior to submittal to any regulatory or permitting agency.
- B. Contractor shall copy the Engineer on all notifications, submittals, and permit applications at the time of submittal to the agency or permitting authority.
- C. If requested by the Owner, the Contractor shall provide copies of permits and/or permissions acquired for work.

1.5 WORK WITHIN A RAILROAD RIGHT OF WAY

- A. **This project includes work within the Union Pacific Railroad right of way. A copy of the Owner's permit or agreement with the railroad, and associated documents, is included in Appendix B – Work in UP Railroad ROW Associated Documents.**
1. Contractor shall familiarize themselves with all requirements of the Maintenance Consent Letter and the Contractor Endorsement.
  2. Contractor shall execute and return the Contractor Endorsement, with the required \$1,025.00 administrative fee, as indicated.
  3. Contractor shall familiarize themselves with the General Terms and Provisions of the Contractor Endorsement ([www.up.com/ce-terms](http://www.up.com/ce-terms)).
  4. Contractor shall submit insurance binders, policies, certificates, and endorsements, as identified in Exhibit A of the General Terms and Provisions for the Contractor Endorsement.
  5. Contractor shall complete Union Pacific's Property Access Training (UP-PAT).
    - (a) Go to the provided web address ([www.up.com/up-pat](http://www.up.com/up-pat)), click on the Vendor Information Form, fill out the form, and submit the completed form with a pdf copy of the signed Contractor Endorsement to the email address at the bottom on the Vendor Information Form. The audit number that will be requested is the REMs/Project number at the top right on the Maintenance Consent Letter form. The badge required for this project is the Union Pacific Property Access Training. The full Erail will not be required for this project.
  6. Contractor shall provide 45 days advance notice to the Railroad Representative, Leo Craig at (817) 901-9560 or [lcraig@olsson.com](mailto:lcraig@olsson.com).
    - (a) Along with this notice, the contractor is required to schedule a short pre-construction meeting with the Railroad Representative prior to commencing work within UPRR ROW. The meeting will further discuss flagging, traffic control, insurance, safety and badging requirements. All personnel intended to be inside the UPRR ROW will need to complete badging, as identified above.
  7. The contractor shall contact one of the two 3rd party approved UP flagging companies directly to schedule flagging ([www.up.com/flagging](http://www.up.com/flagging)), and copy the Railroad Representative on the email.
  8. The contractor shall follow the UP procedures to Call Before You Dig, outlined at the following website: [www.up.com/CBUD](http://www.up.com/CBUD)
- B. The Contractor is reminded that each railway has its own unique requirements and the Contractor is responsible for ascertaining what those requirements are prior to commencing work. While on or about railroad property, The Contractor shall fully comply with the railway's requirements, including (but not limited to) insurance requirements, bond requirements, flagging requirements, and safety requirements. The contractor shall be responsible for fully informing itself as to railroad requirements.
- C. The Contractor shall comply with all provisions of MnDOT Specification 1708 as revised below:
1. The Contractor shall be responsible for all costs associated with meeting the railroad's additional requirements, unless a specific bid item is provided. These costs shall be considered incidental to the contract.
  2. No work shall begin until the proof of insurance forms for all required coverages, and documentation of all required notifications and submittals, are received by the Engineer.

**PART 5 - PRODUCTS (NOT USED)**

**PART 6 - EXECUTION (NOT USED)**

**\*\*\*\*END OF SECTION\*\*\*\***



**SECTION 01 42 13 – ABBREVIATIONS AND ACRONYMS**

**PART 1 - GENERAL**

1.1 WHEREVER THE FOLLOWING ABBREVIATIONS ARE USED, THEY SHALL HAVE THE MEANINGS INDICATED:

- A. AASHTO American Association of the State Highway and Transportation Officials
- B. ACI American Concrete Institute
- C. AI The Asphalt Institute
- D. ASTM American Society for Testing and Materials
- E. AWWA American Water Works Association
- F. CEAM City Engineer's Association of Minnesota
- G. CLFMI Chain Link Fence Manufacturers Institute
- H. MnDOT Minnesota Department of Transportation
- I. OSHA Occupational Safety and Health Administration
- J. PCA Portland Cement Association or Minnesota Pollution Control Agency (context obvious)
- K. SWPPP Storm Water Pollution Prevention Plan

**PART 2 - PRODUCTS (NOT USED)**

**PART 3 - EXECUTION (NOT USED)**

**\*\*\*\*\*END OF SECTION\*\*\*\*\***



## SECTION 01 42 19 - REFERENCE STANDARDS

### PART 1 - GENERAL

The references listed in this section are not all inclusive. There may be other references in individual specification sections that are not listed in this Section.

Portions of referenced specifications not specifically affected by the supplemented information of modification shall remain in effect as originally written.

It is the Contractor's responsibility to have these and all other referenced specifications listed in individual Sections available onsite and to be familiar with them.

- 1.1 ENGINEERS JOINT CONTRACT DOCUMENTS COMMITTEE (EJCDC)
  - A. Documents with the EJCDC copyright notice in the footer are used in this Project Manual under a licensing agreement with EJCDC.
- 1.2 SOIL DISTURBING ACTIVITIES
  - A. Minnesota Pollution Control Agency (MPCA) - General Storm Water Permit for Construction Activity (MN R100001) in force at the day of bid: <http://www.pca.state.mn.us/water/stormwater/stormwater-c.html>
- 1.3 WATERMAIN, SANITARY SEWER AND STORM SEWER CONSTRUCTION
  - A. "Construction Standard Specifications 2022" as published by the City Engineers Association of Minnesota: <http://www.ceam.org>
  - B. American Water Works Association (AWWA) Standards: <http://www.awwa.org/>
- 1.4 GRADING, STREET AND SURFACE IMPROVEMENTS
  - A. All of Divisions II and III, and any specifically referenced Division I sections of the Minnesota Department of Transportation (MnDOT), "MnDOT Standard Specifications for Construction 2020 edition", together with all the Supplemental Specifications in force 30 calendar days prior to bid date: <http://www.dot.state.mn.us/pre-letting/spec/>
  - B. MnDOT Technical Memoranda in force 30 calendar days prior to bid date and referencing the use of English units of measure: <http://www.dot.state.mn.us/design/tools/index.html>
  - C. MnDOT Standard Plans: <http://standardplans.dot.state.mn.us/>
  - D. MnDOT Standard Details: <http://standardplates.dot.state.mn.us/>
  - E. Whenever the word "Contracting Authority," "Department" or "Owner" is used in the sense of ownership as part of any of the MnDOT Documents, it shall mean Owner as defined in the Agreement.
- 1.5 TRAFFIC CONTROL
  - A. The Minnesota Manual of Uniform Traffic Control Devices (MMUTCD) shall apply to this project and is available at: <http://www.dot.state.mn.us/trafficeng/publ/mutcd/>.
  - B. The MnDOT's Temporary Traffic Control Zone Layouts Field available at: <http://www.dot.state.mn.us/trafficeng/publ/fieldmanual/>.
- 1.6 OTHER
  - A. None.

### PART 2 - PRODUCTS (NOT USED)

### PART 3 - EXECUTION

- A. The Contractor shall have access to the reference documents at the site at all times during the construction either in paper or digital format.

**\*\*\*\*END OF SECTION\*\*\*\***

## SECTION 01 45 00 - QUALITY CONTROL

### PART 1 - GENERAL

#### 1.1 SCOPE OF TESTS

- A. All materials, equipment, installation, and workmanship included in this contract, if so required by the Engineer, shall be tested and inspected to prove compliance with the contract requirements.
- B. All tests and inspections shall be completed under the direct supervision of a licensed professional engineer. All tests and inspections shall be the responsibility as identified in the individual sections of these specifications and shall be reported directly to the Owner and Engineer.
- C. No tests specified herein shall be applied until the item to be tested has been inspected and approval given for the application of such tests.
- D. Tests and inspections shall include all those specified in the individual sections and shall be compensated in accordance with the individual sections.
- E. Tests and inspection, unless otherwise specified or accepted, shall be in accordance with the recognized standards of the industry.
- F. Soil compaction testing performed by the Owner is deemed to be for the convenience of the Owner for documentation of the progress and performance of the work. Soil compaction testing results will be made available to the Contractor. However, the Owner and Engineer make no representations that the number of tests taken will be sufficient to accurately characterize the condition of any trench, and the Contractor shall take any supplemental test it deems necessary to monitor its own performance. The Owner may, at its discretion, eliminate soil and compaction testing on any part or the entire project. The presence or absence of soil and compaction testing or the approval of the results thereof shall in no way reduce the Contractor's obligation to correct trench settlement as described in these Special Provisions.

#### 1.2 FINAL TESTING AND START-UP

- A. If, under test, any portion of the work fails to fulfill the contract requirements and is altered, renewed or replaced, tests on that portion so altered, removed, replaced, together with all other portions of the work as are affected thereby, shall, if so required by the Engineer, be repeated within reasonable time and in accordance with the specified conditions and the Contractor shall pay to the Owner all reasonable expenses incurred by the Owner as a result of the carrying out of such tests.

#### 1.3 TESTING AND LABORATORY SERVICES

- A. Independent Testing Laboratory
  - 1. Where in the individual sections of this Specification, tests or inspections are required to be furnished by the Contractor by an independent testing laboratory, the Contractor shall employ and arrange for, at its expense, the services of an approved independent testing laboratory satisfactory to the Engineer to perform the testing utilizing recognized standard procedures and criteria.
- B. Reports and Certificates
  - 1. The Contractor shall submit reports and certificates of all inspections and test to the Engineer in duplicate. The reports and certificates become the property of the Owner.
- C. Sample Materials
  - 1. The Contractor shall furnish all sample materials required for these tests and shall deliver the same without charge to the testing laboratory or other designated agency when and where directed by them.
- D. Additional Tests

1. In addition to those tests required by the individual technical specifications and/or referenced specifications:
  - (a) Additional tests required beyond those required under this specification may be ordered by the Engineer to settle disagreements with the Contractor regarding quality of work done. If the work is defective, the Contractor shall pay all costs of the additional tests and shall correct the work. If the work is satisfactory, the Owner will pay for the additional tests.
  - (b) The Owner may perform televised inspection of any and/or all underground construction included in this project, at its own expense, at any time prior to final payment. All deficiencies discovered in the course of such investigation shall be corrected at the Contractor's expense and, to the Owner's satisfaction, prior to final payment.

#### 1.4 ENGINEER'S REPRESENTATIVES AND TESTING

- A. The Engineer may provide a Resident Project Representative (RPR) to ascertain that the work is accomplished properly and in accordance with the plans and specifications. The RPR shall have full access to the work and shall be given full cooperation. The RPR shall have the authority, subject to the final decision of the Engineer, to reject any defective work or material. The RPR shall have no authority to permit any deviation from the plans and specifications except on written order from the Engineer.
- B. The presence of the Engineer or any RPRs, however, shall not relieve the Contractor of the responsibility for the proper execution of the work in accordance with all requirements of the Contract Documents. Compliance is a duty of the Contractor, and said duty shall not be avoided by any act or omission on the part of the Engineer or any RPRs.

#### 1.5 SITE INVESTIGATION AND CONTROL

- A. The Contractor shall verify all dimensions in the field and shall check field conditions continuously during construction. The Contractor shall be solely responsible for any inaccuracies built into the work due to his failure to comply with this requirement.
- B. The Contractor shall inspect related and appurtenant work and shall report in writing to the Engineer any conditions, which will prevent proper completion of the work. Failure to report any such conditions shall constitute acceptance of all site conditions, and any required removal, repair or replacement caused by unsuitable conditions shall be performed by the Contractor at his sole cost and expense.

#### 1.6 RIGHT OF REJECTION

- A. The Engineer, acting for the Owner, shall have the right, at all time and places, to reject any articles or materials to be furnished hereunder which in any respect, fail to meet the requirements of these specifications, regardless of whether the defects in such articles or materials are detected at the point of manufacture or after completion of the work at the site. If the Engineer or RPR, through an oversight or otherwise, has accepted materials or work which is defective or which is contrary to the specifications, such material, no matter in what stage or condition of manufacture, deliver, or erection, may be rejected by the Engineer for the Owner.

#### **PART 2 - PRODUCTS (NOT USED)**

#### **PART 3 - EXECUTION (NOT USED)**

**\*\*\*\*END OF SECTION\*\*\*\***

## SECTION 01 55 26 - TRAFFIC CONTROL

### PART 1 - GENERAL

#### 1.1 SUMMARY

##### A. Traffic Control

1. All traffic control methods shall conform to the provisions of the latest edition of the Minnesota Manual of Uniform Traffic Control Devices (MN MUTCD), including its supplements and Part VI, "Field Manual for Temporary Traffic Control Zone Layouts", the "Guide to Establishing Speed Limits in Highway Work Zones", the Minnesota Flagging Handbook, the provisions of MnDOT 1404 and 1710, the Minnesota Standard Signs Manuals Parts I and II, the Traffic Engineering Manual Chapter 8 Appendixes 8-8.02 and 8-8.03, the Traffic Control Layouts/Typical Traffic Control Layouts in the Plans.
2. The Contractor shall furnish, install, maintain and remove all traffic control devices including, but not limited to, construction signs, barricades and barricade weights, traffic marking tape, and warning lights which are needed for the guidance, warning and control of traffic adjacent to and through this project.
3. The Contractor shall provide sufficient surveillance of the traffic control devices to ensure compliance during the entire construction period. The Contractor shall furnish names, addresses, and phone numbers of at least two local individuals capable of immediate response who will be responsible for the site security and traffic control devices to:

The Engineer  
The Owner  
Local Law Enforcement Agencies

4. The Contractor shall respond with sufficient personnel, equipment and/or materials and conduct the required work or be subject to a \$100 per hour deduction from the time of notification for non-attention to project security and safety.
5. The Contractor shall schedule the work to cooperate fully with residential and business property owners abutting the project to minimize the time of restricted access to their property during the construction period. Driveway access to any property adjacent to the construction zone shall be restricted no more than seven days to allow for curing of the concrete curb and driveway pavement.
6. The cost of maintaining vehicular and pedestrian traffic on temporary aggregate surfaced drives, walkways, including the eventual removal of the aggregate material, shall be considered incidental to traffic control.
7. If it is necessary to enter upon a right-of-way controlled by the County or Minnesota Department of Transportation, the Contractor shall notify the appropriate agency before commencing construction within the right-of-way.
8. In the event that any of the above right-of-way require traffic to be detoured around the construction zone, the Contractor shall prepare the detour route with the appropriate Agency representatives. The Contractor shall provide and maintain all signing and other traffic control required. The affected Agency shall be notified by the Contractor before re-routing traffic. Dust control and road maintenance of the by-pass route shall be the Contractor's responsibility.
9. The Contractor shall be responsible for securing a site for storage of construction equipment and materials.

##### B. General Construction and Traffic Requirements

1. The parking of Contractor's Vehicles that obstruct any traffic control devices will not be permitted.

1.2 METHOD OF MEASUREMENT AND PAYMENT

- A. Traffic Control shall be measured by the Lump Sum and paid in accordance with the following schedule.
  - 1. First payment at 50 percent, then based on percent completed.
    - (a) 25 percent of contract earned up to 70 percent.
    - (b) 50 percent of contract earned up to 90 percent.
    - (c) 100 percent of contract earned up to 100 percent.

1.3 SUBMITTALS

- A. Proposed Traffic Control Plan
- B. Traffic Control – Contact information for (2) local individuals.
- C. Provide copies of the completed inspection logs on a weekly basis and at the request of the Engineer.

**PART 2 - PRODUCTS (NOT USED)**

**PART 3 - EXECUTION**

3.1 CONSTRUCTION REQUIREMENTS

- A. The Contractor shall notify the Engineer in writing at least 72 hours prior to the start of any construction operation that will necessitate lane closure or internal traffic control signing.
- B. The traffic control devices required along the project corridor shall be delivered and installed prior to the start-up of the work.
- C. The Contractor shall maintain traffic through the intersections whenever possible.
- D. The Contractor shall monitor and maintain all traffic control devices.
- E. Immediately correct discrepancies between actual placement of devices and the traffic control plan.
- F. Immediately respond to requests from the Engineer to improve or correct the traffic control devices.

**\*\*\*\*\*END OF SECTION\*\*\*\*\***



## SECTION 01 55 26.44 - TRAFFIC CONTROL SPECIAL (RR FLAGGING)

### PART 1 - GENERAL

#### 1.1 SUMMARY

##### A. Traffic Control Special (RR Flagging)

1. An allowance is provided on the bid form for coordination of railroad flagging required to construct the project. The Contractor is responsible for all railroad flagging coordination with one of the two approved UP flagging for working within railroad ROW.

#### 1.2 METHOD OF MEASUREMENT AND PAYMENT

##### A. Traffic Control Special (RR Flagging) shall be measured by the Dollar (DOL) and paid in accordance with the following schedule.

1. The Dollar amount paid of this allowance shall equal the actual costs of flagging to meet permitting requirements, as determined based on actual invoices provided to the owner, plus fifteen percent (15%) for overhead and profit.
2. The final Dollar amount paid will be based on the actual costs of railroad flagging required to construct the project. The allowance amount provided may not be paid in its entirety.

#### 1.3 SUBMITTALS

##### A. Invoice(s) for Railroad Flagging paid by the Contractor to the selected flagging company

### PART 2 - PRODUCTS (NOT USED)

### PART 3 - EXECUTION

#### 3.1 CONSTRUCTION REQUIREMENTS

- A. The Contractor shall familiarize themselves with the requirements of the Work within Union Pacific Railroad right-of-way permit, including the required administrative fee, insurance, training, notifications, and submittals. These requirements are detailed further under Section 1.5 (Work Within a Railroad Right of Way) of Section 01 41 26 – Permit Requirements, and in Appendix B – Work in UP Railroad ROW Associated Documents, of this Project Manual.
- B. The contractor shall contact one of the two 3rd party approved UP flagging companies directly to schedule flagging ([www.up.com/flagging](http://www.up.com/flagging)), and copy the Railroad Representative on the email.
  1. The project schedule will be dependent on flagging availability. The contractor is encouraged to reach out to coordinate a flagging schedule early, and shall immediately notify the Engineer of the proposed schedule.
  2. The Contractor shall coordinate their work schedule to complete all work within the railroad ROW within a one-week timeframe. This may require the contractor the bring the roadway up to top of class 5 grade everywhere outside of railroad ROW before commencing work within railroad ROW; then complete all removals, grading, subgrade preparation, road base installation, bituminous pavement, and aggregate shouldering within the railroad ROW concurrently.

\*\*\*\*END OF SECTION\*\*\*\*



## SECTION 01 57 13 – TEMPORARY EROSION AND SEDIMENT CONTROL

### PART 1 - GENERAL

#### 1.1 SUMMARY

- A. This section covers the furnishing of all labor, materials, tools, equipment, and performances of all work and services necessary or incidental to stormwater management as indicated on the plans, as specified herein or as directed by the Engineer.
- B. The Contractor and Owner shall identify a person(s) knowledgeable and experienced in the application of erosion and sediment control Best Management Practices (BMPs) who will oversee the implementation of the SWPPP.
- C. Minnesota Pollution Control Agency (MPCA) - General Stormwater Permit for Construction Activity (MN R100001)
  1. The **Owner** has developed a **Stormwater Pollution Prevention Plan (SWPPP)** in accordance with Part III (Stormwater Discharge Design Requirements) of the National Pollutant Discharge Elimination System (NPDES)/State Disposal System Permit. The SWPPP is included in the project plans.
  2. As a condition of the Award, the Contractor shall be a co-permittee and assume the role of “**Operator**” under the NPDES Permit.
  3. The Owner shall initiate the permit and pay the required fee and submit the NPDES Permit using the data shown in the SWPPP located on Plan Sheets.
  4. **Permittee(s)** will ensure that their **SWPPP** meets all terms and conditions of this permit and that their activities do not render ineffective another party’s **Erosion Prevention and Sediment Control BMPs**.
  5. The Contractor shall maintain copies of the SWPPP on the project site at all times and comply with all provisions contained therein, including performing the required inspections of the erosion control devices and maintaining an Inspector’s Log for the MPCA Stormwater Permit. An Inspector’s Log form is attached at the end of this Section.
  6. The Contractor shall be responsible for keeping the on-site SWPPP documents current and updated to reflect changing conditions as construction progresses.
  7. Process Summary:
    - (a) Owner issues *Notice of Award* to Contractor.
    - (b) The Contractor shall review the SWPPP and may propose changes or a new SWPPP to the Engineer and Owner for review, comment, and Authorization. Changes may be recommended by the Contractor, Engineer, and/or Owner at any time during the construction period to address changing conditions.
      - (1) The responsibility for SWPPP amendments proposed by the Contractor lies with the Contractor. If the Engineer and/or Owner authorize the revisions with no exception taken, such action will not absolve the responsibilities of the Contractor in any way.
      - (2) During the review and modification period, on-site Erosion Control will comply with or exceed the current SWPPP. Pending review by the Engineer and/or Owner shall not alleviate the Contractor’s responsibility to install necessary BMPs to address site issues.
      - (3) Once a SWPPP is modified and/or amended, the Contractor shall distribute new copies to the Owner, the Engineer, the on-site project supervisor, and the resident project representative.
    - (c) The Contractor acknowledges the Notice of Award and provides the Owner with the contact information for the Contractor’s designated SWPPP contact to be used by the Owner for the online

Stormwater Permit Application. Required information includes; Name, Title, Business Mailing Address, Phone Number, and Email for the designated individual.

- (d) Within 7 days of acknowledgment of the Notice of Award by the Contractor, the Owner/Contractor shall submit the Online Stormwater Permit Application to the MPCA.
- (e) No earth disturbing work will begin until the permit coverage date shown on the Coverage Card issued by the MPCA.
- (f) Work will follow the sequence of major activities outlined in the SWPPP.

## 1.2 METHOD OF MEASUREMENT AND PAYMENT

- A. Measurement and compensation for erosion and sediment control will be paid according to the referenced specification or as modified below:
  - 1. Payment for all work associated with Erosion and Sediment Control will be at the contract unit price bid for that item and will be considered full compensation for furnishing, installing, maintaining, and utilizing stormwater best management practices and any work specified in conjunction therewith as well as removing temporary sediment control devices when no longer necessary.
- B. The furnishing and installing specific items and/or the performance of work under certain circumstances will not be individually paid in the absence of a specific bid item for the work. The costs will be included in the unit price bid for the associated erosion control and excavation items. Such items of work include but are not limited to:
  - 1. Complying with the Minnesota Pollution Control Agency (MPCA) - General Stormwater Permit for Construction Activity (MN R100001)
  - 2. Providing trained Construction SWPPP Manager and BMP Installer.
  - 3. Inspect, maintain, repair, and remove (if necessary) temporary surface stabilization practices throughout the project.
  - 4. Maintaining clean exit areas or roads from the site.
  - 5. Sweeping adjacent streets clean of excess soil.
  - 6. Cleaning storm sewers, drain tiles, and culverts that have been partially or completely obstructed by sediment that originated from the site.
  - 7. Geotextile fabric for rock installation.
  - 8. Geotextile fabric to wrap prefabricated inlet protection devices.
  - 9. Aggregate to anchor and act as a filter for prefabricated inlet protection devices.
  - 10. Aggregate associated with the construction of temporary sediment traps.
  - 11. Emergency erosion control mobilization.
  - 12. Construction, maintenance, and removal of rock construction entrance.
  - 13. Changing the type of inlet protection for different phases of construction.
- C. No additional payment will be made for Erosion Control BMPs necessary to accommodate Contractor phasing of the project.
  - 1. If the contractor's construction operations necessitate, the contractor shall provide additional temporary erosion control measures for areas of soil disturbance to meet the requirements of the Stormwater Pollution Prevention Plan and the Construction Stormwater Permit. Additional costs associated with temporary erosion control measures to meet these requirements due to the contractor's progression of work/schedule shall be the responsibility of the contractor and at no cost to the owner.

### 1.3 SPECIFICATION REFERENCES

- A. The following referenced Specifications will apply to this Section:
  - 1. MnDOT 1717
  - 2. MnDOT 2573
  - 3. MnDOT 2574
  - 4. MnDOT 2575
- B. Unless noted otherwise, the provisions in this section are in addition to the referenced specification.

### 1.4 SUBMITTALS

- A. Notice of Coverage from MPCA.
- B. Contact information and training documentation for Construction SWPPP Manager and BMP Installer.
- C. SWPPP Plan Amendments.
- D. Weekly Erosion and Sediment Control Schedule meeting the requirements of MnDOT 1717.
- E. Site Management Plans meeting the minimum requirements of MnDOT 1717. An updated Site Management Plan will be submitted as needed to reflect changes to:
  - 1. Types and/or Locations of BMPs
  - 2. Material Storage and Spill Response
  - 3. Fueling Plans
  - 4. Locations for Stockpiles, Concrete Washout, and Sanitation Facilities and
  - 5. Project Phasing
- F. PDF copies of all SWPPP Documentation including but not limited to:
  - 1. Field Copy of the SWPPP. If the Field Copy has been replaced during Construction with an updated SWPPP, a copy of both the final Field Copy and all intermediate copies will be provided.
  - 2. Inspection Logs including all supporting documents.

## **PART 2 - PRODUCTS**

### 2.1 MATERIALS

- A. For all materials not specifically discussed below no exceptions to the referenced specification are made.
- B. Bale checks shall not be used.

## **PART 3 - EXECUTION**

### 3.1 GENERAL

- A. Construction and/or installation of all appropriate erosion & sediment control devices will be completed before any soil disturbing activities.
- B. Before construction, the Contractor shall observe and document the existing stormwater outfall system and discharge area. Sediment deposits not documented before the construction may be assumed to have originated from the project site and be required to be removed and disposed of by the Contractor.
- C. Before construction, the Owner, Engineer, and Contractor shall review the project to identify critical areas that could require rapid stabilization during the construction process, and develop mitigation and rapid stabilization plans to be incorporated into the SWPPP.

### 3.2 CONSTRUCTION REQUIREMENTS

- A. The Contractor shall provide one or more trained Construction SWPPP Manager(s). The Construction SWPPP Manager will be knowledgeable and experienced in the application of erosion prevention and sediment control BMPs and will oversee the implementation of the SWPPP, and the installation, inspection, and maintenance of the erosion prevention and sediment control BMPs. A Construction SWPPP Manager must be available for an on-site inspection within 72 hours upon request by the Owner and/or MPCA. Failure to provide a trained Construction SWPPP Manager or failure of the Contractor to rectify the situation within 24 hours of written notice if the provided Construction SWPPP Manager fails to adequately perform the duties of Construction SWPPP Manager may result in the Owner or Engineer arranging for the performance of these duties by others.
- B. If the Contractor fails to install and/or perform the appropriate erosion and sediment control practices, as determined by the Engineer, the Engineer may issue a written order to the Contractor. Failure to perform this work within 24 hours of the written notification may result in the Owner or Engineer arranging for the completion of the work by others.
- C. When the Engineer determines that the erosion and/or sediment control practices installed by the Contractor have failed, the Contractor shall correct the cause and alleviate all sediment deposition, to the fullest extent possible. If the corrective action is not taken promptly, the Engineer may issue a written order to the Contractor. Failure to perform this work within 24 hours of notification of non-compliance may result in the Owner or Engineer arranging for the completion of the work by others.
- D. **A contract deduction will be made equal to the total of all costs incurred by the Owner due to the failure of the Contractor to take corrective action within the timeframe of any written notice of non-compliance. Such costs include but are not limited to labor, materials, equipment, and administrative costs.**

### 3.3 TRAINING

- A. The Contractor shall ensure the individual(s) designated by the Contractor for this project to perform the Construction SWPPP Manager and Installation Supervision duties have been trained in accordance with Minnesota Pollution Control Agency (MPCA) General Stormwater Permit for Construction Activity (MN R100001) training requirements.
- B. Documentation incorporated by the Contractor into the SWPPP must include either:
  - 1. Proof of current certification through the University of Minnesota Erosion and Stormwater Management Certification Program, or
  - 2. Documentation of training satisfactory to the MN Pollution Control Agency showing training is commensurate with the individual's job duties.

### 3.4 TERMINATION OF COVERAGE

- A. Upon completion of all final stabilization, the Contractor shall provide the Engineer a signed MN MPCA Notice of Termination (NOT) form and a PDF copy of the SWPPP Documentation. Final payment will not be made for the project until the NOT is submitted and the SWPPP Documentation is received.
- B. The NOT form is available on the MPCA website at: <http://www.pca.state.mn.us/index.php/water/water-types-and-programs/stormwater/construction-stormwater/index.html>

\*\*\*\*END OF SECTION\*\*\*\*

**STORMWATER POLLUTION PREVENTION PLAN - INSPECTION LOG**

Project Title: Vernon Avenue Improvements, Owner: Lower Minnesota River Watershed District, Permit ID: C000\_\_\_\_\_

General Contractor: \_\_\_\_\_

The Contractor is REQUIRED to maintain this record throughout the project.

Inspectors should enter their initials, type, date, and time of the inspection in the blanks provided. After inspecting each shaded area, inspectors should check each box, and make any necessary comments regarding their findings in the blanks provided below and on the back of this sheet.

Refer to the MPCA’s Compliance Guide for Erosion and Sediment Control during the inspection.

Name of Inspector	Type of Inspection		Date and Time of Inspection				Weather		Areas to be Inspected			
	Routine Weekly	24 Hr after a rain event	Month	Day	Year	Time (AM/PM)	Temperature (degrees Fahrenheit)	Rainfall Amount (inches)	All erosion and sediment control BMPs	Temporary Sedimentation Basins	Drainage ditches and other waters of the State	Construction Site Exits
Comments:												
Comments:												
Comments:												
Comments:												

(A digital version of this form is available by request to the Engineer)





**SECTION 01 71 13 – MOBILIZATION**

**PART 1 - GENERAL**

1.1 SUMMARY

- A. This section covers the mobilization of all labor, materials, tools, equipment and performances of all work and services necessary or incidental to construct the project, including but not limited to, the demobilization associated with closing the project, removing all equipment, removing excess materials, and general clean-up.

1.2 METHOD OF MEASUREMENT AND PAYMENT

- A. Mobilization shall be measured by the Lump Sum and paid in accordance with the following schedule.
  - 1. First payment at 50 percent, then based on percent completed
    - (a) 25 percent of contract earned up to 70 percent.
    - (b) 50 percent of contract earned up to 90 percent.
    - (c) 100 percent of contract earned up to 100 percent.

1.3 SPECIFICATION REFERENCES

- A. MnDOT 2021 shall apply to this Section.
- B. Unless noted otherwise, the provisions in this section are in addition to the referenced specification.

**PART 2 - PRODUCTS (NOT USED)**

**PART 3 - EXECUTION (NOT USED)**

**\*\*\*\*\*END OF SECTION\*\*\*\*\***



## SECTION 01 71 23 - FIELD ENGINEERING

### PART 1 - GENERAL

#### 1.1 SUMMARY

A. This section covers staking and record documents, as specified herein, and/or as specified by the Engineer.

#### 1.2 METHOD OF MEASUREMENT AND PAYMENT

A. No direct payment is made for fulfilling the requirements of this section.

#### 1.3 SPECIFICATION REFERENCE

A. The following referenced Specifications will apply to this Section:

1. CEAM 2600.
2. CEAM 2621.

B. Unless noted otherwise, the provisions in this section are in addition to the referenced specification.

#### 1.4 SUBMITTALS

A. Record Documentation, if required in Section 3.2 "Record Documentation" as shown below in this Section.

### PART 2 - PRODUCTS (NOT USED)

### PART 3 - EXECUTION

#### 3.1 STAKING

A. Unless otherwise specified in the specific sections, Owner shall provide engineering surveys to establish reference points for construction as follows:

1. Storm Sewer: Staking will be furnished and set by the Engineer at 50.0-foot spacing (usually offset for construction) for the control of the underground construction herein described. Cuts to the proposed pipeline grade will be furnished by the Engineer. Manholes and catch basins will be staked with an offset and a witness with a cut to the lowest structure invert.
2. Street Grading and Top of Curb:
  - (a) A control line (usually offset from the curb line) with cuts and fills to proposed grade at 50.0-foot spacing on tangents, and 25.0-foot spacing on horizontal or vertical curves, will be furnished and set on both sides for control of the construction herein described.
  - (b) Unless otherwise stated in the applicable section of the Specifications or waived by the Engineer, the Contractor shall provide Blue Tops prior to final paving for subgrade and aggregate base construction.
3. The Engineer will provide horizontal and vertical control points on the project's datum.
4. The Engineer will provide stakes indicating the project stationing.
5. Contractor is responsible to have all areas where stakes need to be set to be clear of debris. The contractor needs to also provide a clear line of sight for staking.
6. The Contractor shall submit staking requests a minimum two (2) working days, excluding Saturdays, Sundays, and legal holidays, prior to the date requested stakes are needed on the project. Staking requests submitted after 2pm will be recorded as being received the next business day.
7. The stakes are an integral part of the project and the Contractor shall protect and preserve all such stakes and marks, and will be charged with the expense of resetting all such stakes and marks destroyed or disturbed due to the Contractor's carelessness or negligence. Stakes that are destroyed

due to vandalism, erosion or other incidents will be re-staked by the Engineer and will not be at the Contractor's expense.

8. In the event of apparent or questionable errors or inconsistencies in such stakes set for control of line and/or grade, the Contractor shall promptly notify the Engineer of such error or inconsistency and shall not proceed with the work until such stake, grade, or mark has been verified or corrected by the Engineer.
  9. The Engineer will mark the existing boundary monuments prior to construction. The Contractor is responsible for protecting the monuments during construction. If monuments are removed the Engineer will reset them post construction at the Contractor's expense.
  10. All other line and grade staking will be the responsibility of the Contractor. The Contractor shall furnish sufficient equipment and personnel for determination of plan grades, cross sections, course thicknesses, etc. The survey cost of establishing stakes requested by the Contractor for the convenience of the Contractor, beyond those cited as basic project control, will be charged to the Contractor or withheld from the amounts due to the Contractor.
- B. Unless otherwise stated in the applicable section of the Specifications or waived by the Engineer, the Contractor shall provide Blue Tops prior to final paving for subgrade and aggregate base construction.

**\*\*\*\*END OF SECTION\*\*\*\***

## SECTION 01 77 00 - CLOSEOUT PROCEDURES

### PART 1 - GENERAL

#### 1.1 FINAL INSPECTION

- A. After the cleaning up of the work, premises, and all other areas and structures connected with the performance of the contract, the work as a whole, will be examined by the Engineer and Owner; and, any workmanship or materials found which do not meet the specified requirements will be identified and included on a punch list given to the Contractor.
- B. The Contractor shall, at its own expense, promptly remove, replace, repair, or otherwise correct the deficiencies with good and satisfactory workmanship and material to the satisfaction of the Owner and Engineer.
- C. In the event that the Contractor does not satisfactorily remove, replace, repair, or otherwise correct the deficiencies within thirty calendar days after receipt of the punch list, the Owner reserves the right to employ the services of other contractors and/or service organizations to conduct the necessary work and deduct any and all associated costs from final payment to the Contractor. The entry of such other agents on the project to perform this work will not relieve the Contractor from any of its warranty, maintenance or start-up obligations.

#### 1.2 PROJECT ACCEPTANCE

- A. The project will be accepted after the final examination has been conducted and all settlement, defects, damages, etc., discovered during the previous examination have been remedied.

### PART 2 - PRODUCTS (NOT USED)

### PART 3 - EXECUTION (NOT USED)

\*\*\*\* END OF SECTION \*\*\*\*



TECHNICAL SPECIFICATIONS

for

Vernon Avenue Improvements

OT1.129866

Lower Minnesota River Watershed District

Savage, MN





## SECTION 02 41 13 - SELECTIVE SITE DEMOLITION

### PART 1 - GENERAL

#### 1.1 SUMMARY

- A. This section covers the furnishing of all labor, materials, tools, equipment, and performances of all work and services necessary or incidental to the removal of pavement and miscellaneous structures as indicated on the drawings or as specified herein.

#### 1.2 METHOD OF MEASUREMENT AND PAYMENT

- A. Measurement and compensation for the following items will be paid according to the referenced specification or as modified below:
  - 1. The unit price bid for removing pavement and miscellaneous structures will include all costs of labor, materials, equipment, and ultimate disposal required to complete the work, as specified.
- B. The furnishing and installing of specific items and/or the performance of work under certain circumstances will not be individually paid in the absence of a specific bid item for the work. The costs will be included in the unit price bid for the associated removal and excavation items. Such items of work include but are not limited to:
  - 1. Saw cutting - bituminous and/or concrete, driveways, sidewalks, pavements, curb & gutter, and other impervious surfaces.
  - 2. Removing storing and reinstalling mailboxes, street/traffic signs, or similar structures which must be moved to construct the project.
  - 3. Off-site disposal of excess excavated material and debris.
  - 4. Removal and off-site disposal of bituminous or concrete, unless designated for salvaging.
    - (a) The bid item for Remove Bituminous Pavement covers removal of all existing bituminous pavement and existing deteriorated bituminous pavement/gravel surface, as indicated on the plans.
  - 5. Removing, salvaging, and storing, or disposing of manhole and catch basin castings.
  - 6. Loading, hauling, stockpiling, and placing as directed (i.e., leveling) designated salvage items to a location directed by the Owner.
  - 7. Fees and permits for the disposal of materials.
  - 8. Removal and disposal of existing sanitary sewer pipe, storm sewer pipe, watermain, and service pipes.
  - 9. Bulkheading the ends of existing pipes designated by the Engineer to be abandoned in place.
  - 10. Protection from damage of structures or other surface improvements that are not to be removed, and subsequent repair and/or replacement if damaged by Contractor operations.
- C. Re-sawing bituminous and/or concrete edges as needed to provide straight and vertical edges just prior to constructing new pavement.

#### 1.3 SPECIFICATION REFERENCES

- A. The following referenced Specifications will apply to this Section:
  - 1. MnDOT 2104.
- B. Unless noted otherwise, the provisions in this section are in addition to the referenced specification.

#### 1.4 SUBMITTALS

- A. No submittals for this section.

**PART 2 - PRODUCTS**

2.1 MATERIALS

- A. No exception to this Section is made.

**PART 3 - EXECUTION**

3.1 CONSTRUCTION REQUIREMENTS

- A. Remove existing bituminous, curb and gutter, walks, drives, steps, and other specified items where shown on the plans and/or required for the construction of the project.
- B. Saw cut bituminous and concrete surfaces before excavation, to produce a clean-cut breakage joint.
- C. Dispose of all concrete and bituminous removal items, rubbish, and debris outside of the construction zone. It will be the Contractor's responsibility to secure all required permits and pay all fees associated with the disposal of the material and secure the disposal site.
- D. Remove existing mailboxes, street/traffic signs, and similar structures that must be removed to construct the project. Restore these facilities to the original location or a location designated by the Owner when work has progressed past the location of the structure.
- E. The Contractor shall take full responsibility to protect structures or other surface improvements from damage that are not to be removed. If damage to these facilities occurs due to the construction of the project, the Contractor shall replace or repair them.
- F. Saw cut bituminous and concrete surfaces before excavation and just prior to final construction as needed to produce a clean-cut breakage joint.

**\*\*\*\*END OF SECTION\*\*\*\***

## SECTION 31 11 00 - CLEARING AND GRUBBING

### PART 1 - GENERAL

#### 1.1 SUMMARY

- A. This section covers the furnishing of all labor, materials, tools, equipment, and performances of all work and services necessary or incidental to clearing and grubbing trees, stumps, and brush as indicated on the drawings or as specified herein.

#### 1.2 METHOD OF MEASUREMENT AND PAYMENT

- A. Measurement and compensation for the following items will be paid according to the referenced specification or as modified below:
  - 1. No exception to the referenced specification is made.
- B. The furnishing and installing of specific items and/or the performance of work under certain circumstances will not be individually paid in the absence of a specific bid item for the work. The costs will be included in the unit price bid for clearing and grubbing. Such items of work include but are not limited to:
  - 1. Permits and fees for the disposal of materials.
  - 2. Protecting existing improvements from damage.

#### 1.3 SPECIFICATION REFERENCES

- A. MnDOT 2101 will apply to this Section.
- B. Unless noted otherwise, the provisions in this section are in addition to the referenced specification.

#### 1.4 SUBMITTALS

- A. No submittals for this section.

### PART 2 - PRODUCTS

#### 2.1 MATERIALS

- A. No exception to this section is made.

### PART 3 - EXECUTION

#### 3.1 CONSTRUCTION REQUIREMENTS

- A. Before tree clearing operations, the Contractor shall inspect the tree to be removed for the presence of eagles nests.
  - 1. If absent, tree trimming will be completed without time restrictions.
  - 2. If present, the Contractor shall document with photos to the best of their ability and contact the Engineer before initiating tree clearing. Tree removal may not proceed until authorized in writing by the Engineer.
- B. Tree clearing seasonal restrictions do not apply to grubbing.
- C. Before tree trimming to remove overhanging branches, the Contractor shall inspect the branches to be trimmed for occupied bird nests and/or hollows that may be used by birds or bats.
  - 1. If absent, tree trimming will be completed without time restrictions.

2. If present, the Contractor shall document with photos to the best of their ability and contact the Engineer before initiating tree trimming. Tree trimming may not proceed until authorized in writing by the Engineer.
- D. All trees, stumps, brush, seed, grass, roots, or other undesirable material within the construction limits will be disposed of by the Contractor.
- E. Disposal methods will be approved by the Engineer and shall meet all Local, State, and Federal regulations.
- F. Burning or burial will not be allowed within city limits.

**\*\*\*\*END OF SECTION\*\*\*\***

## 31 20 00 EXCAVATION AND EMBANKMENT

### PART 1 - GENERAL

#### 1.1 SUMMARY

- A. This section covers the furnishing of all labor, materials, tools, equipment and performance of all work and services necessary or incidental to the excavation and embankment for roadways and pavements as indicated on the drawings or as specified herein.

#### 1.2 METHOD OF MEASUREMENT AND PAYMENT

- A. Measurement and compensation for the following items shall be paid according to the referenced specification or as modified below:
1. Common Excavation:
    - (a) Measurement and payment for Excavation - Common shall be based upon the CUBIC YARD, PLAN QUANTITY - CY(P).
      - (1) Payment for Plan Quantity (P) Items: Items designated as Plan Quantity (P) shall be measured and paid for based on the quantity listed in the plans and no field measurement shall be made. The Engineer will only adjust the quantities on Plan Quantity (P) designated Contract items when the Engineer authorizes changes to the dimensions of that work (in which case only the affected portion will be re-determined) or when the Engineer determines that the quantity designated as a Plan Quantity (P) is incorrect.
    - (b) Common excavation is computed to the face of any retaining walls. Excavation required for construction of the wall shall be incidental to the unit price bid for retaining wall.
  2. Subgrade Excavation:
    - (a) All excavation directed by the Engineer below the common excavation zone or limits indicated in the typical sections or cross sections in the plans shall be considered Subgrade Excavation, except where conducted for utility construction. This is considered the existing soils beneath the select granular embankment section.
    - (b) Measurement and payment for Excavation - Subgrade will be by the CUBIC YARD, EXCAVATED VOLUME - CY (EV) based on the dimensions of the excavated area.
    - (c) The quantities for Subgrade Excavation is strictly an estimate and may be increased or decreased by any amount with no adjustment in unit price according to the conditions revealed.
  3. Backfill for Subgrade Excavations:
    - (a) No direct compensation will be made for backfilling subcut areas with suitable material from the excavation.
    - (b) Measurement and payment for Stabilizing Aggregate will be by the CUBIC YARD, COMPACTED VOLUME – CY (CV), and will be compensation for the installation of stabilizing aggregate used to backfill subgrade excavations, as directed by the Engineer.
    - (c) The quantities for materials used to backfill subgrade excavations are strictly estimates and may be increased or decreased by any amount with no adjustment in unit price according to the conditions revealed. The Engineer in the field will determine the material to be used as backfill for subgrade excavations.
  4. Minor Grading:
    - (a) Grading up to each storm sewer culvert apron and around the installed riprap to provide proper drainage into and away from each culvert apron. The work includes the clearing or accumulated

debris and sediment to allow for the completion of the minor grading. Grading shall be completed to generally match the existing drainage ditch and provide for proper drainage.

- (b) Measurement and payment for Minor Grading will be by the LINEAL FOOT – LF along the centerline of the drainage ditch from the culvert apron invert to the proposed grading limits, and will be compensation for the clearing of accumulated debris/sediment and re-grading to provide proper drainage, as directed by the Engineer.
- (c) Minor grading shall be completed with the use of a skid steer, or alternative method/equipment approved by the Engineer.

5. Topsoil Borrow:

- (a) No direct compensation will be made for salvaging, stockpiling and replacing topsoil salvaged from within the construction limits.
- (b) Measurement and payment for furnishing and installing topsoil borrow shall be based upon the CUBIC YARD, LOOSE VOLUME - CY (LV).
- (c) The quantities for topsoil borrow are strictly estimates and may be increased or decreased by any amount with no adjustment in unit price according to the extent of existing topsoil salvaged and other conditions revealed.

B. The furnishing and installing of specific items and/or the performance of work under certain circumstances shall not be individually paid. The costs shall be included in the unit price bid for the associated excavation items. Such items of work include but are not limited to:

1. Disposal of bituminous/aggregate reclamation material that is determined by the Engineer to be unsuitable for re-use.
2. Salvaging, separating, separately stockpiling and re-spreading topsoil material in turf areas to the depths specified or indicated on the plans.
3. Salvaging and separately stockpiling suitable aggregate base material, as determined by the Engineer.
4. Separating, salvaging, stockpiling and installing subgrade excavation backfill, as determined by the Engineer.
5. Earthwork balancing including adjustments for shrinkage loss, and excess materials resulting from the additional volume created from pipe bedding, utility pipe, and/or underground structures shall be included in the unit price bid for common excavation.
6. Protecting existing improvements and previously accepted in-process improvements from damage.
7. Protecting infiltration areas.
8. The avoidance of wetlands.
9. Subcutting the existing topsoil prior to placing embankment in all roadway, patio and trail locations.
10. Subgrade excavation, furnishing stabilizing aggregate, geotextile fabric installation, compaction, regrading and/or other efforts necessary to repair the subgrade for failing to protect the integrity of the subgrade after it has been accepted (test rolled).
11. Removal and disposal of existing mulch, shrubs, plantings, stones/boulders, landscape rock, plastic landscape edging, paver/block landscape edging, and other minor landscape items designated for removal.

1.3 SPECIFICATION REFERENCES

- A. MnDOT 2105 shall apply to excavation and embankment, except as modified herein.
- B. MnDOT 2106 shall apply to excavation and embankment, except as modified herein.

- C. MnDOT 2574 shall apply to excavation and embankment, except as modified herein.
- D. Unless noted otherwise, the provisions in this section are in addition to the referenced specification.

1.4 SUBMITTALS

- A. Gradation testing shall be taken from material in stock at locations approved by the Engineer. All sampling methods shall be approved by the Engineer.

**PART 2 - PRODUCTS**

2.1 MATERIALS

- A. All excess excavated material shall become the property of the Contractor and shall be removed from the site and disposed of at a site secured by the Contractor.
- B. Frozen material shall be considered unsuitable material unless otherwise authorized in writing by the Engineer.
- C. Excavated material unsuitable for embankment and backfill construction shall become the property of the Contractor and shall be removed from the site and disposed of at a site secured by the Contractor.
- D. Stabilizing aggregates for use in backfilling subgrade excavations shall be material generally produced and referred to as "3-inch dust free aggregate" or other coarse aggregate found to be in general compliance by the Engineer.

**PART 3 - EXECUTION**

3.1 CONSTRUCTION REQUIREMENTS

- A. At the end of each day the Contractor shall eliminate surface indentations, including those caused by sheeps foot rollers, tractor tires and tracked equipment, and roll the surface with a steel wheel or rubber tired roller except in those areas designated to be protected from compaction.
- B. Subgrade excavation shall be performed, as directed by the Engineer, for the removal of any unstable soils that may be encountered. Such excavation shall be backfilled with suitable excess common excavation material or stabilizing aggregate as directed by the Engineer. If the Contractor proceeds without approval from the Engineer or Owner, all work and material to restore the roadbed to the proper grade shall be at the Contractor's expense.
- C. The Contractor shall salvage and stockpile all topsoil removed during the course of the construction. This topsoil shall be used where required for turf establishment as directed by the Engineer.
- D. Sufficient excavated material shall be utilized by the Contractor to replace loss volume due to soil shrinkage from trench excavation that may occur through the course of construction. The Contractor shall make his own determination of the amount of shrinkage that will occur.
- E. All embankment shall be compacted using the Ordinary Compaction method.

3.2 SOURCE QUALITY CONTROL

- A. The Owner may arrange for having the following testing performed:
  - 1. One gradation test per each 500 tons or 275 cubic yards of select granular embankment.
  - 2. One gradation test for stabilizing aggregate.
- B. Samples for testing shall be taken from material in stock at locations approved by the Engineer. All sampling methods shall conform to MnDOT standards.

\*\*\*\*END OF SECTION\*\*\*\*





## SECTION 31 23 13 - SUBGRADE PREPARATION

### PART 1 - GENERAL

#### 1.1 SUMMARY

- A. This section covers the furnishing of all labor, materials, tools, equipment, and performance of all work and services necessary or incidental to the subgrade preparation as indicated on the drawings or as specified herein.

#### 1.2 METHOD OF MEASUREMENT AND PAYMENT

- A. Measurement and compensation for the following items will be paid according to the referenced specification or as modified below:
  - 1. No direct payment will be made for subgrade preparation. Costs will be included in the unit prices bid for the various excavation items.
- B. The furnishing and installing of specific items and/or the performance of work under certain circumstances will not be individually paid in the absence of a specific bid item for the work. The costs will be included in the unit price bid for the various excavation items. Such items of work include but are not limited to:
  - 1. Drying and adding water to the subgrade.
  - 2. Subgrade excavation, furnishing stabilizing aggregate, geotextile fabric installation, compaction, regrading, and/or other efforts necessary to repair the subgrade after satisfying the rolling test and failing to protect the integrity of the subgrade.
  - 3. Test rolling the compacted subgrade.

#### 1.3 SPECIFICATION REFERENCES

- A. MnDOT 2112 will apply to this Section.
- B. Unless noted otherwise, the provisions in this section are in addition to the referenced specification.

#### 1.4 SUBMITTALS

- A. No submittals for this section.

### PART 2 - PRODUCTS

#### 2.1 MATERIALS

- A. No exception to the referenced specification is made.

### PART 3 - EXECUTION

#### 3.1 CONSTRUCTION REQUIREMENTS

- A. At the end of each day, and before the placement of aggregate base, the Contractor shall eliminate surface indentations, including those caused by sheeps foot rollers and tractor cletes, and roll the surface with a steel wheel or rubber-tired roller.
- B. The Contractor shall disc, scarify, shape and compact the street subgrade or existing base, adding water or drying as may be necessary to give uniform and desired density.
- C. If the subgrade is unstable and the instability is due to excessive moisture, the subgrade will be scarified and dried over a reasonable period. When the material has reached acceptable moisture limits, the material will be returned to the roadbed and compacted into place to the proper elevation. The roadbed will once again be test rolled. If the material continues to be unstable, the Engineer may authorize the removal of the undesirable material as subgrade excavation.

- D. Once the subgrade has been test rolled and accepted by the Engineer, no traffic or construction equipment will be permitted to operate directly on the subgrade without the prior approval of the Engineer. All equipment will be restricted to operating only in areas where the aggregate base has been installed to its full design depth. If inclement weather occurs after a test roll, and before placement of the aggregate base or first course of bituminous, the test roll will be voided and a new test roll will be performed.
- E. The subgrade will be compacted in accordance with the Quality Compaction Method.

3.2

FIELD QUALITY CONTROL

- A. "Blue Top" stakes will be provided by the Contractor at 50 foot intervals to confirm that the subgrade is constructed to the required grades and elevations. Methods other than "Blue Top" staking may be allowed if approved by the Engineer.
- B. The compacted subgrade will be test rolled using a fully loaded aggregate truck (tandem) in a pattern approved by the Engineer. The subgrade stability will be considered adequate when the surface shows less than 1.0 inch of yielding or rutting after one pass, or as otherwise approved by the Engineer.

**\*\*\*\*END OF SECTION\*\*\*\***

## SECTION 31 23 19 - DEWATERING

### PART 1 - GENERAL

#### 1.1 SUMMARY

- A. This section covers the furnishing of all labor, materials, tools, equipment, and performances of all work and services necessary or incidental to the dewatering of trenches as necessary to construct the elements shown on the drawings or as specified herein, including but not limited to culvert removal, riprap removal, culvert installation, minor ditch grading, and riprap installation.
- B. This item will be considered exempt from the requirements of Supplementary Condition 13.03.

#### 1.2 METHOD OF MEASUREMENT AND PAYMENT

- A. Payment will be at the Lump Sum Contract price bid. Payment will be compensated in full for all costs relative thereto, including, but not limited to permit approval, permit fees, investigation, design, installation, operation, maintenance repair, replacement, piping, monitoring, temporary bulkheads, temporary cofferdams, temporary sheet pile installation, temporary piping, temporary pumping, settling basins and other permanent and temporary construction features.
- B. The furnishing and installing of specific items and/or the performance of work under certain circumstances will not be individually paid in the absence of a specific bid item for the work. The costs will be included in the unit price bid for the dewatering items, as indicated. Such items of work include but are not limited to:
  - 1. Interference of other underground structures and utilities.
  - 2. Protection of existing improvements from damage.
  - 3. Removal of temporary cofferdams, etc.

#### 1.3 SPECIFICATION REFERENCES

- A. MnDOT 2106 will apply to this Section.
- B. MnDOT 2451 will apply to this Section.
- C. Unless noted otherwise, the provisions in this section are in addition to the referenced specification.

#### 1.4 SUBMITTALS

- A. Dewatering Plan.

### PART 2 - PRODUCTS

#### 2.1 MATERIALS

- A. No exception to this section is made.

### PART 3 - EXECUTION

#### 3.1 CONSTRUCTION REQUIREMENTS

- A. The Contractor shall furnish and install all necessary discharge piping and obtain all permits, easements, rights-of-way, etc. to convey and discharge the water at a sufficient distance from the project area to eliminate recharge of the groundwater at the project site.
- B. Water from dewatering operations will not be discharged where it will pond or cause damage to cropland or personal property due to the presence of standing or flowing water.
- C. Unless otherwise provided in the contract documents; the Contractor shall be responsible for obtaining all necessary permits required for dewatering prior to the beginning of dewatering. The Contractor shall

provide a plan for the discharge showing the discharge location, energy dissipation, and water quality treatment to the Engineer for approval before beginning discharge. The discharge rate, location, and water quality will meet all local, State, and Federal requirements.

- D. Existing and/or proposed sanitary system(s) shall not be used as an outlet for the dewatering operations.
- E. Method of dewatering may be chosen by the Contractor; however, no silt or dirty water can be pumped to adjacent ditches, drainageways, ponds, lakes, or storm structures. The chosen method shall be described in a dewatering plan submitted to and reviewed by the Owner prior to starting dewatering activities.

**\*\*\*\*END OF SECTION\*\*\*\***

## SECTION 31 37 00 - RIPRAP

### PART 1 - GENERAL

#### 1.1 SUMMARY

- A. This section covers the furnishing of all labor, materials, tools, equipment, and performances of all work and services necessary or incidental to construct the riprap and geotextile fabric as indicated on the drawings or as specified herein.

#### 1.2 METHODS OF MEASUREMENT AND PAYMENT

- A. Measurement and compensation for the following items will be paid according to the referenced specification or as modified below:
  - 1. Payment for riprap will be by the Ton based on actual weigh tickets. The amount bid will be compensation in full for all costs of excavating, removing, and disposing of, if necessary, all materials encountered in the course of riprap placement.
- B. The furnishing and installing of specific items and/or the performance of work under certain circumstances will not be individually paid in the absence of a specific bid item for the work. The costs will be included in the unit price bid for the associated rip-rap items. Such items of work include but are not limited to:
  - 1. Granular filter material and/or geotextile fabric.
  - 2. Excavation is required to place rip-rap.

#### 1.3 SPECIFICATION REFERENCES

- A. The following referenced Specifications will apply to this Section:
  - 1. MnDOT 2511.
  - 2. MnDOT 3601.
  - 3. MnDOT 3733.
- B. Unless noted otherwise, the provisions in this section are in addition to the referenced specification.

#### 1.4 SUBMITTALS

- A. No submittals for this section.

### PART 2 - PRODUCTS

#### 2.1 MATERIALS

- A. The material to be used will be the class riprap and fine filter aggregate shown on the plans as specified in MnDOT 3601.
- B. The geotextile fabric shall meet the requirements of MnDOT 3733, Type 4, unless otherwise shown on the plans.
- C. The Contractor may choose the type of filter material, except as restricted for geotextile filters, unless the type is specified on the plans.

### PART 3 - EXECUTION

#### 3.1 CONSTRUCTION REQUIREMENTS

- A. No exception to the referenced specification is made.

\*\*\*\*END OF SECTION\*\*\*\*



## SECTION 32 11 23 - AGGREGATE BASE COURSES

### PART 1 - GENERAL

#### 1.1 SUMMARY

- A. This section covers the furnishing of all labor, materials, tools, equipment and performances of all work and services necessary or incidental to construct the aggregate base course as indicated on the drawings or as specified herein.

#### 1.2 METHODS OF MEASUREMENT AND PAYMENT

- A. Measurement and compensation for the following items shall be paid according to the referenced specification or as modified below:
  - 1. No exception to the referenced specification is made.
- B. The furnishing and installing of specific items and/or the performance of work under certain circumstances shall not be individually paid in the absence of a specific bid item for the work. The costs shall be included in the unit price bid for the associated aggregate items. Such items of work include but are not limited to:
  - 1. Protecting existing improvements and previously accepted in-process improvements from damage.
  - 2. Subgrade excavation, furnishing stabilizing aggregate, geotextile fabric installation, compaction, regrading and/or other efforts necessary to repair the subgrade after satisfying the rolling test and failing to protect the integrity of the subgrade.
  - 3. The cost of all labor, equipment and materials necessary for meeting the testing requirements of field quality control, if required, include in price bid for Aggregate Base.
  - 4. Furnishing and installing blue tops for gravel surface.
  - 5. Test rolling of the compacted aggregate base using a fully loaded aggregate truck (tandem).

#### 1.3 SPECIFICATION REFERENCES

- A. MnDOT 2211 shall apply to the construction of aggregate base, except as modified herein.
- B. Unless noted otherwise, the provisions in this section are in addition to the referenced specification.

#### 1.4 SUBMITTALS

- A. Provide the following test results for each source of aggregate:
  - 1. Two gradation tests
  - 2. One percent crushing test (only if requested by Engineer).
  - 3. One aggregate quality test (only if requested by Engineer).

### PART 2 - PRODUCTS

#### 2.1 MATERIALS

- A. Aggregate base shall be 100 percent crushed quarry rock (limestone) Class 5, as specified in MnDOT 3138.2B.
  - 1. When the project calls for 100 percent crushed aggregate base, the material to be used shall conform to the Specifications for Aggregate Base Class 5, modified so that the material consists of 100 percent crushed rock. The gradation shall also be modified so that the percent passing the No. 200 sieve shall be 5 to 10 percent.

**PART 3 - EXECUTION**

**3.1 CONSTRUCTION REQUIREMENTS**

- A. At the end of each day the Contractor shall eliminate surface indentations, including those caused by sheeps foot rollers and tractor cletes, and roll the surface with a steel wheel or rubber-tired roller.
- B. The depth and class of aggregate base to be constructed shall be as shown on the plans. Aggregate base construction shall take place only after the street subgrade condition and grade has been examined by the Engineer.
- C. Pneumatic rollers are required for compaction on all aggregate base courses with recycled bituminous unless otherwise approved by the Engineer.
- D. Aggregate base shall be compacted to the requirements specified using the 2211.3D.2.a "Specified Density Method" (100% Standard Proctor Density) or 2211.3D.2.c "Penetration Index Method" (Table 2211.3-3) as directed by the Engineer.

**3.2 SOURCE QUALITY CONTROL**

- A. The Owner may arrange for having the following testing performed:
  - 1. One gradation test for each 500 tons or 275 cubic yards (CV) of each class of aggregate base.
  - 2. One percent crushing test.
  - 3. One aggregate quality test.
- B. Samples for testing shall be taken from material in stock at locations approved by the Engineer. All sampling methods shall be approved by the Engineer.
- C. Should any of the specified tests fail, the Contractor may arrange and pay for additional tests as may be necessary to satisfy the Engineer that the requirements have been met.

**3.3 FIELD QUALITY CONTROL**

- A. "Blue top" stakes shall be provided by the Contractor at 50.0-foot intervals to confirm that the base is constructed to the required grades and elevations. Methods other than "blue top" staking may be allowed, if approved by the Engineer.
- B. The Owner may arrange for having the following testing performed:
  - 1. One density test per 2000 SY of each class of aggregate base, minimum of 3 tests per project.
  - 2. One moisture test per project (not required for reclaimed aggregate base material).
- C. Any required Contractor testing shall be performed by an independent testing laboratory approved by the Engineer.
- D. The Contractor shall cooperate fully with the individuals performing the tests.
- E. Samples for testing shall be taken from material in place, in the roadway at locations approved by the Engineer. All sampling methods shall be approved by the Engineer.
- F. Should any of the specified tests fail, the Contractor may arrange and pay for additional tests as may be necessary to satisfy the Engineer that the requirements have been met.

**\*\*\*\*END OF SECTION\*\*\*\***



## SECTION 32 12 00 - FLEXIBLE PAVING

### PART 1 - GENERAL

#### 1.1 SUMMARY

- A. This section covers the furnishing of all labor, materials, tools, equipment and performances of all work and services necessary or incidental to the construction of plant-mixed bituminous surfacing utilizing the MnDOT Gyratory Design Specification (2360) as indicated on the plans or as specified herein.
- B. This is a Certified Plant Project. The supplier shall have sufficient testing facilities and qualified personnel including Certified Technicians. All required plant and field tests shall be performed in a timely manner and with a good quality control program.

#### 1.2 METHOD OF MEASUREMENT AND PAYMENT

- A. Measurement and compensation for the following items shall be paid according to the referenced specification or as modified below:
  - 1. Payment for the accepted quantity of asphalt emulsion and cutback shall be at the Contract price per gallon for undiluted asphalt emulsion and neat cutback. Should the Contract fail to include a Contract Item covering payment for the bituminous material used for tack coat, all costs of furnishing and applying bituminous tack coat material will be included in the compensation provided for the bituminous mixture, with no measurement made of the bituminous material used and with no direct compensation being made therefore.
  - 2. Payment shall be at the unit price bid per TON of bituminous surfacing for the respective bituminous courses. The amount bid shall include all material and work required to mix and place the bituminous course specified.
  - 3. The Contractor shall allow one thousand dollars (\$1,000) in the bid to cover the expense of taking ten (10) random, 3.0-inch diameter core samples and patching the bore holes. Should any or all of the core samples be deleted, the proportionate core expense shall be deducted from the final project cost. Additional core samples required by the Engineer shall be compensated at thirty dollars (\$30) per core.
- B. No payment adjustment shall be made for density.
- C. This project is not subject to the provisions of MnDOT 2399.
- D. The furnishing and installing of specific items and/or the performance of work under certain circumstances shall not be individually paid in the absence of a specific bid item for the work. The costs shall be included in the unit price bid for the associated bituminous paving items. Such items of work include but are not limited to:
  - 1. Equipment and materials necessary for meeting the testing requirements of Source Quality Control for the bituminous tack coat, if required, include in price bid for bituminous tack coat.
  - 2. The cost of all labor, equipment and materials necessary to comply with plant and field testing requirements of MnDOT 02360, include in price bid for Plant-Mixed Bituminous Surfacing.
  - 3. The cost of all labor, equipment and materials necessary for constructing clean, vertical, solid edge at the adjacent asphalt surface for both non-wear and wear courses, include in the price bid for Plant-Mixed Bituminous surfacing.
  - 4. Sawcutting the bituminous edges and removing of damaged bituminous just prior to the construction of the next lift of bituminous course.

#### 1.3 SPECIFICATION REFERENCE

- A. MnDOT 2360 shall apply, except as modified herein.

- B. MnDOT 2357 shall apply, except as modified herein.
- C. MnDOT 3139 shall apply, except as modified herein.
- D. Unless noted otherwise, the provisions in this Section are in addition to the referenced specification.

1.4 SUBMITTALS

- A. Bituminous Mix Design (wear and non-wear).

**PART 2 - PRODUCTS**

2.1 MATERIALS

- A. Bituminous Tack Coat:

1. The bituminous material for tack coat will be limited to one of the following kinds of emulsified asphalt. However, the Engineer may authorize the use of medium cure cutback asphalt (MC-250) during the early and late construction season when it is anticipated the air temperature may drop below 32 degrees Fahrenheit. Cutback asphalt shall be used only when approved by the Engineer.

(a) Emulsified Asphalt

- (1) Anionic SS-1, SS-1h
- (2) Cationic CSS-1, CSS-1h

(b) Cutback Asphalt:

- (1) Medium Cure Liquid Asphalt MC-250

2. Only Certified Sources are allowed for use. MnDOT's Certified Source List is located at the following link: <http://www.dot.state.mn.us/products/index.html>.

- B. Bituminous material and aggregate shall be as shown on the typical sections in the plans.

**PART 3 - EXECUTION**

3.1 CONSTRUCTION REQUIREMENTS

- A. Bituminous Tack Coat

1. The tack coat shall not be applied when the road surface or weather conditions are unsuitable as determined by the Engineer.
2. At the time of applying bituminous tack coat material, the road surface shall be dry and clean and all necessary repairs or reconditioning work shall have been completed as provided for in the Contract and approved by the Engineer.
3. Unless otherwise indicated in the Plans or provisions, the bituminous tack coat material shall be applied within the application rates shown in the table below as based on pavement type or condition and type of bituminous material. The Engineer shall approve the time and rate of application. Only a MnDOT certified asphalt emulsion supplier is allowed to dilute the emulsion. When diluted, the supplier shall provide asphalt emulsion diluted 1-part emulsion to 1-part water. Dilution of asphalt emulsion in the field is not allowed. The Engineer may waive the tack coat requirement when multiple lifts are paved on the same day.

Pavement Type or Condition	Application Rate - gallons/sy		
		Undiluted Emulsion SS-1, SS-1H, CSS-1, CSS-1H	Diluted Emulsion (1 part Emulsion to 1 part water) <sup>1</sup> SS-1, SS-1H, CSS-1, CSS-1H

New HMA	0.03 – 0.05	0.06 – 0.10	0.03 – 0.05
Aged HMA <sup>3</sup> or Un-milled PCC	0.05 – 0.08	0.10 – 0.15	0.05 – 0.08
Milled HMA or Milled PCC	0.07 – 0.10	0.14 – 0.20	0.07 – 0.10

<sup>1</sup>As provided by the asphalt emulsion supplier

<sup>2</sup>When approved by the Engineer

<sup>3</sup>Older than 1 year

4. The temperature of the bituminous material at the time of application shall be approved by the Engineer, within the limits specified following:
  - (a) SS-1, SS-1H, CSS-1, CSS-1H .....70 to 160 Degrees Fahrenheit
  - (b) MC-250 .....165 to 220 Degrees Fahrenheit
- B. The Contractor is required to use the self-propelled pneumatic tire roller as an intermediate roller on the wearing courses.
- C. Cut the adjacent asphalt surface prior to construction of the bituminous surface course to obtain a clean, vertical, solid edge.
- D. Compaction of all bituminous mixtures shall be by the Maximum Density Method.
  1. Longitudinal Joint Cores:
    - (a) The first paragraph of 2360.3.D.1 of the referenced MnDOT 2360 (Plant Mixed Asphalt Pavement) Specification is hereby deleted and replaced with the following:
 

**D.1 Maximum Density**

Compact the pavement to at least the minimum required maximum density values in accordance with table 2360 19, “required minimum lot density (mat)”.
    - (b) Table 2360-20 Longitudinal Joint Density Requirement of the referenced MnDOT 2360 (Plant Mixed Asphalt Pavement) Specification is hereby deleted.
    - (c) 2360.3.D.1.h Mat Density Cores of the referenced MnDOT 2360 (Plant Mixed Asphalt Pavement) Specification is hereby deleted and replaced with the following:
 

**D.1.h Mat Density Cores**

Obtain four cores in each lot. Take two cores from random locations as directed by the Engineer. Take the third and fourth cores, the companion cores, within 1.0-foot longitudinally from the first two cores. Submit the companion cores to the Engineer immediately after coring and sawing. If the random core location falls on an unsupported joint, at the time of compaction, (the edge of the mat being placed does not butt up against another mat, pavement surface, etc.) cut the core with the outer edge of the core barrel 1.0-foot away (laterally) from the edge of the top of the mat (joint). If the random core location falls on a confined joint (edge of the mat being placed butts up against another mat, pavement surface, curb and gutter, or fixed face), cut with the outer edge of the core barrel 6.0-inches ± 0.5-inch from the edge of the top of the mat (ex. center of 4.0-inch core barrel 8.0-inches ± 0.5-inches] from the edge of the top of the mat). Cores will not be taken within 1.0-foot of any unsupported edge. The Contractor is responsible for maintaining traffic, coring, patching the core holes, and sawing the cores to the paved lift thickness before density testing.

The Engineer may require additional density lots to isolate areas affected by equipment malfunction, heavy rain, or other factors affecting normal compaction operations.
    - (d) 2360.3.D.1.j Companion Core Testing of the referenced MnDOT 2360 (Plant Mixed Asphalt Pavement) Specification is hereby deleted and replaced with the following:

- (1) The Engineer will select at least one of the two companion cores per lot to test for verification
- (e) 2360.3.D.1.n Longitudinal Joint Density of the referenced MnDOT 2360 (Plant Mixed Asphalt Pavement) Specification is hereby deleted.
- (f) 2360.3.D.1.p Shoulders of the referenced MnDOT 2360 (Plant Mixed Asphalt Pavement) Specification is hereby deleted.
- (g) Table 2360-24 Payment Schedule for Longitudinal Joint Density (SP Wear and SP Shoulders, 4 percent Void) of the referenced MnDOT 2360 (Plant Mixed Asphalt Pavement) Specification is hereby deleted.
- (h) Table 2360-25 Payment Schedule for Longitudinal Joint Density (SP Non-wear and SP Shoulders, 3 percent Void) of the referenced MnDOT 2360 (Plant Mixed Asphalt Pavement) Specification is hereby deleted.
- (i) 2360.3.D.1.r Pay Factor Determination of the referenced MnDOT 2360 (Plant Mixed Asphalt Pavement) Specification is hereby deleted.

3.2 SOURCE QUALITY CONTROL

- A. The bituminous mix shall be designed using Contractor Trial Mix Designs. A current MnDOT mix design may be accepted provided it represents the aggregate source and bituminous plant being used for the project, and is approved by the Engineer. No bituminous mixture shall be placed without an approved mix design.
- B. Testing of the material bituminous tack coat may be required, if determined by the Engineer, that the material appears suspect.
- C. The Contractor shall cooperate fully with the individuals performing the tests.

3.3 FIELD QUALITY CONTROL

- A. If required by the Engineer, cores for mat density and for lift thickness verification shall be taken, except that for daily production less than 300 tons, the Engineer may require that two cores are taken (one for Contractor testing and one companion core). Sample locations shall be designated by the Engineer and made with a drilling device that produces clean sharp, vertical edges.
- B. Lift Thickness Tolerances:
  - 1. If any cores indicate lift thicknesses outside of the specified tolerances, the Contractor may, at its own cost and expense, take additional core samples to further define the extent of the deficiency.
  - 2. The Engineer shall calculate deficient pavement areas using the locations and thickness results of all core samples and prorating the thickness profile.
  - 3. At the discretion of the Engineer as an alternative to removal and replacement, the Engineer may allow a \$1.00 deduction per square yard will be made for each 1/8-inch deficiency of thickness beyond the specified tolerances.
  - 4. Reduction in payment for bituminous courses constructed to more than the maximum permissible thickness, except that the thickness tolerances specified herein apply.
- C. Testing:
  - 1. For projects with 2000 tons or less of a particular mix type, delete Tables 2360-10 and 2360-11 of the referenced MnDOT 2360 and substitute the following:

<b>Production Test</b>	<b>Sampling and Testing Rates (each mix type)</b>	<b>Test Reference (Laboratory Manual unless otherwise indicated)</b>	<b>Spec Section</b>
Bulk Specific Gravity		1806	2360.2.G.7.b

Production Test	Sampling and Testing Rates (each mix type)	Test Reference (Laboratory Manual unless otherwise indicated)	Spec Section
Maximum Specific Gravity	Divide the planned production by 500. Round up to the next whole number	1807	2360.2.G.7.c
Air Voids (calculated)		1808	2360.2.G.7.d
Asphalt Content		1853	2360.2.G.7.a
Add AC/Total AC Ratio (calculated)		1853	2360.2.G.7.a
Adj. AFT (Calculated)		1854	2360.2.E.7.e
Gradation	1 gradation per 500 tons or portion thereof (at least one per day)	1203	2360.2.G.7.f
Coarse Aggregate Angularity	1 test per 500 tons or portion thereof. If CAA >8 percent of requirement, 1 sample per day but test 1 per week.	1214	2360.2.G.7.g
Fine Aggregate Angularity (FAA)	1 test per 500 tons or portion thereof. If FAA >5 percent of requirement, 1 sample per day but test 1 per week.	1213	2360.2.G.7.h
Fines to Effective Asphalt Ratio (calculated)	Divide the planned production by 500. Round up to the next whole number	1203 & 1853	2360.2.G.7.f & 2360.2.G.7.a
TSR	As directed by the Engineer	1213	2360.G.7.i
Aggregate Specific Gravity	As directed by the Engineer	1204, 1205, and 181	2360.G.7.j
Mixture Moisture Content	Daily unless otherwise required by the Engineer	1805	2360.G.7.k
Asphalt Binder	As directed by the Engineer]	MnDOT Bituminous Manual 5-693.920	2360.G.7.l

2. Contractor shall send a copy of the testing results to the Engineer.
3. Should any of the specified tests fail, the Contractor shall notify the Engineer immediately and shall arrange and pay for additional test as may be necessary to satisfy the Engineer that the requirements have been met.

\*\*\*\*END OF SECTION\*\*\*\*



## SECTION 32 15 00 - AGGREGATE SURFACING

### PART 1 - GENERAL

#### 1.1 SUMMARY

- A. This section covers the furnishing of all labor, materials, tools, equipment and performances of all work and services necessary or incidental to construct the aggregate surfacing / shouldering as indicated on the drawings or as specified herein.

#### 1.2 METHODS OF MEASUREMENT AND PAYMENT

- A. Measurement and compensation for the following items shall be paid according to the referenced specification or as modified below:
  - 1. No exception to the referenced specification is made.
- B. The furnishing and installing of specific items and/or the performance of work under certain circumstances shall not be individually paid in the absence of a specific bid item for the work. The costs shall be included in the unit price bid for the associated aggregate surfacing items. Such items of work include but are not limited to:
  - 1. Protecting existing improvements and previously accepted in-process improvements from damage.
  - 2. Subgrade excavation, furnishing stabilizing aggregate, geotextile fabric installation, compaction, regrading and/or other efforts necessary to repair the subgrade after satisfying the rolling test and failing to protect the integrity of the subgrade.
  - 3. The cost of all labor, equipment and materials necessary for meeting the testing requirements of field quality control, if required.
  - 4. Furnishing and installing blue tops for aggregate surfacing.
  - 5. Test rolling of the compacted aggregate surface using a fully loaded tandem axle truck.

#### 1.3 SPECIFICATION REFERENCES

- A. MnDOT 2118 shall apply to the construction of aggregate surfacing, except as modified herein.
- B. MnDOT 2221 shall apply to the construction of aggregate shouldering, except as modified herein.
- C. Unless noted otherwise, the provisions in this section are in addition to the referenced specification.

#### 1.4 SUBMITTALS

- A. Provide the following test results for each source of aggregate:
  - 1. Two gradation tests (only if requested by Engineer).

### PART 2 - PRODUCTS

#### 2.1 MATERIALS

- A. Materials included here consist of new aggregate surfacing, Class 2. If additional rock is used to provide a coarser Class 2 gradation, the added materials must pass the Los Angeles Rattler (L.A.R.) test.

### PART 3 - EXECUTION

#### 3.1 CONSTRUCTION REQUIREMENTS

- A. At the end of each day the Contractor shall eliminate surface indentations, including those caused by sheeps foot rollers, tractor tires and tracked equipment, and roll the surface with a steel wheel or rubber tired roller.

- B. The depth and class of aggregate surfacing to be constructed shall be as shown on the plans. Aggregate surfacing construction shall take place only after the subgrade or aggregate base condition and grade has been examined by the Engineer.
- C. Existing aggregate surfacing shall be salvaged prior to commencing trenching activities, and shall be restored after underground construction is completed.
- D. Compaction of the aggregate surfacing courses shall be by the Quality Compaction Method.
- E. The compacted aggregate shall be test rolled using a fully loaded tandem axel truck in a pattern approved by the Engineer. The stability of the compacted aggregate shall be considered adequate when the surface shows less than 1.0-inch of yielding or rutting after one pass, or as otherwise approved by the Engineer. Test rolling shall be incidental.

3.2 SOURCE QUALITY CONTROL

- A. The Contractor shall perform and pay for Contractor Quality Control Testing in accordance with the MnDOT Schedule of Materials Control.
- B. Samples for testing shall be taken from material in stock at locations approved by the Engineer. All sampling methods shall be approved by the Engineer.
- C. The Contractor shall cooperate fully with the individuals performing the tests.
- D. The OWNER will arrange for and pay for Quality Assurance (QA) testing. Should any of the specified (QA) tests fail, the Contractor shall pay for additional tests as may be necessary to satisfy the Engineer that the requirements have been met. If the material is determined to be out of compliance with the MnDOT 2211, price reductions or material rejections will be implemented per MnDOT 2211.

**\*\*\*\*\*END OF SECTION\*\*\*\*\***



## SECTION 32 91 19.13 - TOPSOIL PLACEMENT AND GRADING

### PART 1 - GENERAL

#### 1.1 SUMMARY

A. Section Includes:

1. All labor, materials, equipment, and supervision required to furnish and install amended soil and topsoil to finished grade, as shown on the Plan Sheets.

#### 1.2 MEASUREMENT AND PAYMENT

A. Measurement and compensation for the following items shall be paid according to the referenced specification or as modified below:

1. Payment for amended soil and topsoil shall be by the CUBIC YARD based on plan quantity for each type of topsoil specified. The amount bid shall be compensation in full for all costs of area preparation, transportation, placement, and final grading as shown on the plan sheets.

#### 1.3 SPECIFICATION REFERENCE

A. MnDOT 3877 Topsoil Materials

B. Unless noted otherwise, the provisions in this section are in addition to the referenced specification.

#### 1.4 SUBMITTALS

A. No submittals for this section.

### PART 2 - PRODUCTS

#### 2.1 MATERIALS

A. Unless otherwise specified on the plans, topsoil types shall be provided as follows:

1. Common Topsoil Borrow shall be used for areas to be seeded or sodded.

### PART 3 - EXECUTION

#### 3.1 SHRUB, TREE, AND PERENNIAL PLANT BED PREPARATION

- A. Loosen surface of subgrade to minimum 2.0-inch depth to insure a positive bond between subgrade and topsoil.
- B. Do not place finish topsoil until after clean-up and removal of construction debris, trash, surplus materials, and equipment from project site.
- C. In perennial and shrub planting beds, place and spread topsoil to a uniform settled depth that is approximately 66.67 percent of the overall settled depth.
- D. Where topsoil is spread, use a cultipacker, pulverizer, or similar tool to pulverize the soil and eliminate all lumps. Do not compact topsoil.
- E. Provide settled depth of amended soil in all shrub and perennial plant beds as shown in the drawings. Provide backfill for tree root balls as shown on the plans.
- F. Finish grade plant bed areas as shown on the Drawings.

#### 3.2 TOPSOIL PLACEMENT AND FINISH GRADING FOR SOD

- A. Topsoil should be placed to a 6.0-inch finished depth in all areas to be sodded.
- B. Prepare soil for planting so that only light raking, or scarifying will be required.

- C. Round finished surfaces at abrupt changes in slope.
- D. Should spot elevations for finished grades conflict with finished contours, the spot elevations shall govern.
- E. Finished grades shall be to top of sod.
- F. Finished grades to uniform levels or slopes between points where levels are given or between such points and existing grades.
- G. Positively drain all sod and planting areas to designated surface water collection points, streets, and/or waterways.
- H. Protect paving, sidewalks, utilities, and plants during finish grading; repair or replace any items damaged by construction operations at no cost to Owner. Equipment that may leave black tire marks should not be driven on sidewalk or paver areas, or marks must be removed, without damage to walks or pavers, prior to project acceptance.
- I. After placement, maintain surfaces to indicated finished grades; deposit additional topsoil or amended soil to repair settlement or erosion up to the date of final acceptance. Scarify surfaces upon which additional topsoil is to be deposited.

3.3 BORROW TOPSOIL IN ABOVE-GRADE PLANTERS

- A. Place according to manufacturer's recommendations.

3.4 MAINTENANCE

- A. Protection of graded areas:
  1. Protect newly graded areas from traffic and erosion.
  2. Keep free of trash and debris.
  3. Repair and re-establish grades in settled, eroded, and rutted areas to specified tolerances.
  4. Keep public streets clean from soil, soil tracking, and debris at all times.
- B. Reconditioning Compacted Areas: Where completed graded areas are disturbed by subsequent construction operations, erosion or adverse weather, scarify surface, re-shape, and compact to required density prior to further construction at no cost to the Owner.
- C. Settling: Where settling is measurable or observable during general project warranty period, add topsoil or amended soil, compact, and replace surface treatment. Restore appearance, quality, and condition of surface or finish to match adjacent work and eliminate evidence of restoration at no cost to the Owner.

3.5 DISPOSAL OF EXCESS AND WASTE MATERIALS

- A. Remove waste materials, including unacceptable excavated material, trash, and debris from the job site.

3.6 PROTECTION OF SIDEWALK

- A. Equipment that may leave black tire marks shall not be driven on sidewalk or special paver areas, or marks must be removed without damage to walks prior to acceptance.

\*\*\*\*END OF SECTION\*\*\*\*

## SECTION 32 92 00 – TURF AND GRASSES

### PART 1 - GENERAL

#### 1.1 SUMMARY

- A. This section covers the furnishing of all labor, materials, tools, equipment and performances of all work and services necessary or incidental to turf restoration as indicated on the drawings or as specified herein.
- B. A variety of different seeding mixtures may be utilized on this project. The Contractor shall refer to the plan for the locations of the different turf establishment areas.
- C. Temporary seeding may be necessary during construction in erosion sensitive areas. The Contractor shall do temporary seeding work as specified herein or as directed by the Engineer.

#### 1.2 METHOD OF MEASUREMENT AND PAYMENT

- A. Measurement and compensation for the following items shall be paid according to the referenced specification or as modified below:
  - 1. All measurements for payments for turf establishment items shall be based on the Unit Price bid per item.
  - 2. Payment for Rolled Erosion Prevention Category 20 w/ Seed Mixture shall be by the SQUARD YARD (SY) and shall be compensation in full for the installation of seed, fertilizer, and blanket, as specified.
- B. The furnishing and installing specific items and/or the performance of work under certain circumstances shall not be individually paid in the absence of a specific bid item for the work. The costs shall be included in the unit price bid for the associated seeding and sodding items. Such items of work include but are not limited to:
  - 1. Application of starter fertilizer on all areas to be sodded or seeded shall be included in the price bid for the associated bid item.
  - 2. Subgrade preparation and topsoil placement as required on all areas shown on the plans.
  - 3. Maintenance of newly sodded and seeded areas, as specified, include in the unit price for the associated items.
  - 4. Stapling of sod on sloped areas, include in the unit price bid for sodding.

#### 1.3 SPECIFICATION REFERENCES

- A. The following referenced Specifications will apply to this Section:
  - 1. MnDOT 2574.
  - 2. MnDOT 2575.
  - 3. MnDOT 3876.
  - 4. MnDOT 3877.
  - 5. MnDOT 3878.
  - 6. MnDOT 3881.
  - 7. MnDOT 3882.
  - 8. MnDOT 3884.
  - 9. MnDOT 3885.
- B. Unless noted otherwise, the provisions in this section are in addition to the referenced specification.

1.4 SUBMITTALS

- A. Seeding - Certificates of Compliance for seed mixture.

**PART 2 - PRODUCTS**

2.1 MATERIALS

A. Seeding

1. The seed mixtures to be used are shown on the plans.
2. Unless otherwise specified on the plans, all application rates for MnDOT mixes, except temporary seed, are 150 percent the specified rate.
3. Type 1 mulch shall consist of clean straw with no pasture hay.
4. Seed must be obtained from as close to the project site as reasonably possible with an emphasis on obtaining seed from the local ecotype region.
5. Source identified (Yellow tag) seed through the Minnesota Crop Improvement Association (MCIA) unless otherwise approved by the Engineer.
6. All seed shall be supplied as pure-live seed (PLS).
7. All seed and seed mixes shall conform to State seed requirements for noxious weed content.
8. All seed and seed mixes shall conform to State labeling requirements. For all species in the mix, the label and or invoice shall include the county of origin, and if from Canada, the province.

B. Sodding Items

1. Unless otherwise indicated on the plans, sod shall be Lawn Sod as defined in the referenced specification except when located within MnDOT right-of-way where Salt Tolerant Sod shall be utilized.

C. Imported Topsoil

1. Unless otherwise indicated on the plans, imported topsoil borrow for general use as a turf growing medium shall comply with MnDOT 3877.2.A.
2. Unless otherwise indicated on the plans, imported topsoil borrow for use as a plant growing medium in designated areas such as landscape beds shall meet the requirements of MnDOT 3877.2.B.

D. Fertilizer

1. Fertilizer shall be per MnDOT specification.
2. Fertilizer shall be applied at a rate indicated in the MnDOT specification.

E. Hydraulic Matrix

1. Hydraulic Matrix shall be MnDOT Type Bonded Fiber Matrix
2. Hydraulic Matrix shall be applied at a rate of 3500 lbs/acre (dry weight)

**PART 3 - EXECUTION**

3.1 CONSTRUCTION REQUIREMENTS

A. GENERAL

1. The subgrade shall be shaped to the approximate contour of the finished surface. All construction debris shall be removed from the area prior to the placement of the topsoil. The subgrade shall be loosened with a disc or harrow to a depth of 6.0-inches prior to application of the topsoil.

2. The topsoil shall be shaped to the approximate contour of the finished surface, with a minimum depth of 4.0-inches, unless otherwise shown on the plan. All construction debris, rocks and trash shall be removed from the area prior to seeding or sodding. The topsoil shall be loosened with a disc or harrow to its full depth prior to seeding or sodding.
3. The Contractor shall be responsible for providing water and maintenance for a period of 30 calendar days, or until final acceptance by the Owner, to firmly establish the seed or sod. The term maintenance includes mowing, weed control and watering, as necessary. Failure to perform this work within 24-hours of notification of non-compliance may result in the Owner or Engineer arranging for completion of the work by others. A contract deduction will be made equal to the total of all costs to perform such work so arranged, including but not limited to, labor, materials, equipment and administrative costs.
4. Where dormant seeding or sodding is authorized, the maintenance period will be extended to include the first 30 calendar days after the beginning of the growing season. The beginning of growing season will be defined as bud burst.

**B. SEEDING REQUIREMENTS**

1. Turf establishment by seeding shall be done utilizing the various combinations of seed mixtures (including aquatic plants), fertilizing and mulching at disturbed areas as shown on the plans.
2. Areas prepared for seeding shall be free of rocks, debris and clumps of soil. The areas shall be graded uniformly, and vegetated areas shall be raked free of chunks exceeding ½-inch diameter.
3. Seed shall be applied with a drill seeder, unless otherwise approved by the Owner.
4. The Contractor shall furnish weight tickets documenting pounds of hydraulic soil stabilizer placed, pounds of fertilizer placed, and pounds of seed placed. The seed tickets shall show individual plant species along with the percent purity and percent germination. The fertilizer tickets shall show mix proportions. The Contractor shall also furnish its QA/QC data to the Engineer.
5. Dormant seeding and snow seeding may be utilized in accordance with the referenced specification and technical memorandum, provided the final acceptance standards are met.
6. Final acceptance of seeding will be based on an established growth of 6.0-inches with a uniform density to cover 70 percent of the designated area, free of weeds and bare spots. Any re-seeding necessary shall be performed at the Contractor's expense.

**C. SODDING REQUIREMENTS**

1. Sod shall be placed by the Contractor in the locations shown on the plans as directed by the Engineer.
2. When placing sod in irregularly shaped locations, the Contractor shall produce sharp, straight joints between sod rolls.
3. Sod shall be placed to create a firm, smooth, uniform surface without ruts, knobs or wrinkles.
4. Sod placed on slopes greater than 1:4 (v:h), in ditch bottoms, and around storm sewer inlets or outlets shall be anchored with staples. Staples shall be U shaped 0.12-inch diameter or heavier steel wire having a span width of 1.0-inch and a length of 8.0-inches from top to bottom, after bending.
5. All re-work necessary to repair imperfections in sod placement shall be made at the Contractor's expense.

**\*\*\*\*END OF SECTION\*\*\*\***



## SECTION 33 05 06 - TRENCHING AND BACKFILLING

### PART 1 - GENERAL

#### 1.1 SUMMARY

- A. This section covers the furnishing of all labor, materials, tools, equipment, and performances of all work and services necessary or incidental to the maintenance of utility service, trench excavation, bedding, and backfill necessary for the construction of underground utilities and structures, as indicated on the drawings or as specified herein.

#### 1.2 DEFINITIONS

- A. Excess Material - Material that is not needed to complete the earthwork balance.
- B. Suitable Material - Sand, silty sand, or low plasticity clay soils with no organic content. The Engineer shall make the final determination as to what material will be considered suitable.
- C. Unsuitable Material - Soil with organic content including topsoil, swamp deposits, peat, muck, or other material deemed by the Engineer to be unsuitable for fill or embankment construction.
- D. Flexible Pipe Materials – For this specification section, flexible pipe materials will include the following:
  - 1. Polyvinyl chloride (PVC) pipe – solid wall and profile wall pipe.
  - 2. Polypropylene profile wall pipe.
  - 3. High-density polyethylene pipe – solid wall and profile wall pipe.
  - 4. Corrugated steel or aluminum pipe.
  - 5. Centrifugally cast glass-fiber-reinforced, polymer mortar (CCFRPM) pipe.
- E. Rigid Pipe Materials – For this specification section, rigid pipe materials will include the following:
  - 1. Reinforced concrete pipe.
  - 2. Reinforced concrete box culverts.
  - 3. Ductile iron pipe.

#### 1.3 METHOD OF MEASUREMENT AND PAYMENT

- A. Measurement and compensation for the following items will be paid according to the referenced specification or as modified below:
  - 1. Items specifically identified in the Schedule of Unit Prices will be compensated following the description of measurement and payment contained in the section applicable to the individual item. No direct compensation will be granted for compliance with the provisions contained herein.
- B. The furnishing and installing of specific items and/or the performance of work under certain circumstances will not be individually paid in the absence of a specific bid item for the work. The costs will be included in the unit price bid for the individual pipeline items associated with the stated specific item or work effort. Such items of work include but are not limited to:
  - 1. Interference with other above and underground structures and utilities.
  - 2. The removal and restoration, or protection of existing structures and utilities that are shown on the plans and for which there is no bid item for removing and restoring or working around the utility.
  - 3. Unless separately itemized in the Schedule of Unit Prices, any dewatering is necessary for construction.
  - 4. Foundation materials placed instead of performing necessary dewatering.

5. Bulkheading of existing pipes to be abandoned in place.
6. Granular foundation, granular bedding, and granular encasement materials.
7. Granular foundation materials used instead of bedding materials in the specified bedding zone, where specified.
8. Granular foundation materials used in unstable trench conditions.
9. The removal and disposal of native materials that are unsuitable for bedding and/or backfill.
10. Providing and maintaining utility service.
11. The replacement of all material displaced due to shrinkage or loss during the excavation and backfilling operations.
12. The removal of excess materials above the original topography resulting from the additional volume created from pipe bedding, utility pipe, and/or underground structures.
13. Delays due to other utility conflicts that result during construction.
14. Protecting existing improvements and previously accepted elements of this construction from damage.
15. Protecting the inverts of other utility pipes from the accumulation of debris and soil, the removal of blockages that threaten to damage property, and/or the cleaning of both the newly constructed lines and the existing lines of all debris and soil that accumulated during the construction.
16. If a separate bid item for bypass pumping is NOT included in the Schedule of Unit Prices, providing temporary bypass pumping/control of stormwater flows around the construction zone, will be included in the price bid for the associated items being installed.
17. The use of special construction techniques such as trench boxes, sheeting, shoring, etc., will be included in the price bid for the associated items being installed.
18. Compaction testing and compaction, if required, will be included in the price bid for the associated items being installed.

#### 1.4 SPECIFICATION REFERENCES

- A. CEAM 2600 will apply, except as modified herein.
- B. MnDOT 2451 will apply, except as modified herein.
- C. Unless noted otherwise, the provisions in this section are in addition to the referenced specification.

#### 1.5 SUBMITTALS

- A. Gradation Test Results for any granular borrow materials.
- B. Two separate tests, as required in Source Quality Control provisions of individual sections contained herein, from material stockpiles of aggregates to be used on this project. These tests may be run by the Contractor or its supplier during aggregate production.

### **PART 2 - PRODUCTS**

#### 2.1 GRANULAR MATERIALS

- A. Granular Bedding and Granular Encasement – No exception to the referenced specification is made.
- B. Granular Backfill - No exception to the referenced specification is made.

### **PART 3 - EXECUTION**

#### 3.1 EXCAVATION AND PREPARATION OF TRENCH



A. Interference and Protection of Underground Structures

1. If an existing utility is shown on the plans and there is no bid item for removing and restoring, or working around the utility, the Contractor shall be required to remove and restore, or protect the utility.
2. The inverts of existing sewers (storm & sanitary), culverts, subdrains, etc. will be protected during construction. The Contractor is responsible to inspect and clean, if necessary, all lines which have become compromised by the construction operations.

B. Excavation Limits and Requirements

1. The trench for all flexible pipe will be undercut 6.0-inches below the pipe barrel to permit the installation of granular bedding or foundation material.
2. The trench for all rigid pipe will be undercut 3.0-inches below the pipe barrel, or as shown in the bedding detail, to permit the installation of granular bedding or foundation material.
3. The Contractor shall install and operate a dewatering system to maintain all trenches free of water wherever necessary. The Contractor shall make their subsurface investigations and determine what dewatering methods to utilize to prevent such damage.
4. The Contractor shall be responsible for any damage to adjacent structures or buildings caused by the dewatering operations.
5. Use of granular foundation material in place of performing dewatering is permitted.
6. All excess excavated material will become the property of the Contractor and will be removed from the site and disposed of at a location secured by the Contractor.

3.2 INSTALLATION OF PIPE AND FITTINGS

- A. The Contractor shall keep accurate records as to the location of the service connections, field tile, utility crossings, etc. either constructed or encountered during the construction. Measurements to service lines will be taken from the two nearest permanent structures (i.e., hydrants, valves, manholes, buildings). Final payment for the project will not be made until the information is in the possession of the Owner.
- B. When connection to an existing conduit is required at an existing or proposed manhole, the Contractor shall expose and verify the elevation of the existing conduit before laying any pipe toward, or away from, the connection point. If the elevation of the existing conduit does not match the elevation shown on the plans, the Contractor shall notify the Engineer, at which time the Engineer may adjust the proposed grades.
- C. Sewer Pipe at Structures
1. The pipe end(s) will be extended inside the structure a maximum of 3.0-inches unless approved otherwise by the Engineer or shown on the plans.
- D. Connection and Assembly of Joints
1. For sanitary sewer, watermain, forcemains, and culverts, all joints will be water-tight.
  2. For storm sewers and subdrains, all joints will not permit the intrusion of soil or backfill materials.
    - (a) If a reinforced concrete pipe is used, the Contractor may at its discretion choose to wrap each joint with a geotextile filter fabric, as specified, rather than place mastic in the joint.
- E. Bulkheading Open Pipe Ends
1. The Contractor shall furnish, install and maintain a temporary, water-tight plug adequately blocked in place to prevent flooding of the existing downstream sewer system. The plug will be placed at the beginning of the project or the end of each working day at the end of the day's operation.

2. When flows are diverted from an existing sewer or tile to be abandoned in place, the Contractor will construct a water-tight plug on the open end of the abandoned pipe.
3. Permanent watertight plugs will be constructed with concrete grout with a thickness of not less than 1 pipe diameter.

### 3.3 BEDDING AND BACKFILLING OPERATIONS

- A. Backfill material around all manholes, catch basins, valve boxes, curb boxes, and hydrants will be compacted with hand machines. The maximum lift thickness will be 6.0-inches.
- B. Flexible Pipe Materials
  1. Unless otherwise shown on the plans, the pipe will be bedded and backfilled with granular material compacted to 95 percent Standard Proctor Density or as recommended by the pipe manufacturer, whichever is denser, from 6.0-inches below the bottom of the pipe to 12.0-inches above the top of the pipe the full width of the trench. The Contractor shall bed and backfill the pipe as shown on the plan details.
  2. Where the trench foundation is unstable and not suitable for bedding, the trench will be undercut until acceptable conditions are found. The Contractor shall then install compacted foundation material to meet the line and grade specified on the plan.
  3. Unless otherwise shown on the plans, select native material will be used as a trench backfill above the granular bedding up to the bottom of the subgrade except in those conditions where the top of the pipe is less than 12.0-inches from the bottom of the subgrade in which case granular material compacted to 100 percent Standard Proctor Density will be used as trench backfill the full width of the trench to the bottom of the subgrade excavation zone.
- C. Rigid Pipe Materials
  1. Unless otherwise shown on the plans, in ordinary or stable trench conditions, the bottom of the trench will be first excavated to a depth of approximately 15 percent of the outside pipe diameter below the established grade for the bottom of the pipe. Then the bottom of the trench will be further excavated to allow for the placement of 6.0-inches of granular bedding for a width of at least 60 percent of the outside diameter of the pipe. A pipe will be placed on the bottom of the pre-shaped excavated trench. The bottom of the excavated trench will be shaped to fit the circumference of the pipe up to 0.15 of the outside diameter of the pipe. The Contractor shall encase the pipe from the 0.15 outside diameter to the 0.60 diameter height of the pipe with granular material compacted to 95 percent Standard Proctor Density or as recommended by the pipe manufacturer, whichever is denser.
  2. Where the trench foundation is unstable and not suitable for bedding, the trench will be undercut until acceptable conditions are found. The Contractor shall then install compacted foundation material to meet the line and grade specified on the plan.
  3. Unless otherwise shown on the plans, select native material may be used as trench backfill above the granular bedding up to the bottom of the subgrade except in those conditions where the top of the pipe is less than 12.0-inches from the bottom of the subgrade in which case granular material compacted to 100 percent Standard proctor Density will be used as trench backfill the full width of the trench to the bottom of the subgrade excavation zone.
- D. Structures
  1. All manholes, catch basins, valve boxes, water vaults, headwalls, and miscellaneous structures will be backfilled with granular backfill material and will be compacted with a hand-operated motorized compactor.
- E. All trench backfill will be compacted in accordance with the Quality Compaction Method.

### 3.4 SOURCE QUALITY CONTROL

- A. The Contractor shall arrange for having the following testing performed:
  - 1. One gradation test per every 500 tons or 275 cu yd (CV) of granular materials.

3.5 FIELD QUALITY CONTROL

- A. No exception to the referenced Specification is made.

**\*\*\*END OF SECTION\*\*\***



## SECTION 33 42 00 - STORMWATER CONVEYANCE

### PART 1 - GENERAL

#### 1.1 SUMMARY

- A. This section covers the furnishing of all labor, materials, tools, equipment and performances of all work and services necessary or incidental to storm sewer construction as indicated on the drawings or as specified herein.

#### 1.2 METHOD OF MEASUREMENT AND PAYMENT

- A. Measurement and compensation for the following items shall be paid according to the referenced specification or as modified below:
1. Manholes
    - (a) Payment for all manholes shall be at the unit price bid per LINEAR FOOT of structure as measured from the invert of the outlet pipe to the top of the manhole casting. The amount bid includes all work and material required to complete the structure. Casting assemblies shall be paid separately for each assembly furnished and installed.
  2. Catch Basins
    - (a) Payment for all catch basins shall be at the unit price bid per LINEAR FOOT of structure as measured from the invert of the outlet pipe to the flow line of the catch basin casting. The amount bid includes all work and material required to complete the structure. Casting assemblies shall be paid separately for each assembly furnished and installed.
  3. Casting Assemblies
    - (a) Casting assemblies shall be measured per EACH, complete in place and paid at the unit price bid.
    - (b) Chimney Seal
    - (c) Chimney seals shall be measured per EACH structure, furnished and installed, for the type and style indicated and paid at the unit price bid. The amount bid includes all work and materials required to place the chimney seal from the top of the precast concrete structure to the middle of the casting.
  4. Sewer Pipe
    - (a) No exception to the referenced specification is made.
  5. Aprons
    - (a) No exception to the referenced specification is made.
  6. Connect to Existing Storm Manhole
    - (a) Payment for connecting a new storm sewer to an existing storm manhole shall be measured and paid per EACH, as specified in the Schedule of Unit Prices, complete and in place, at the appropriate unit price bid. The amount bid shall include removing the existing storm sewer pipe, enlarging the hole, removing the bench and reshaping the invert, if necessary to fit the proposed storm sewer pipe.
  7. Raise / Lower Existing Manhole
    - (a) Payment for raising or lowering an existing manhole shall be measured and paid per lineal foot based on the vertical difference between the existing and final rim elevations. The payment shall include all cost of labor, materials and equipment required to complete the work.

- B. The furnishing and installing of specific items and/or the performance of work under certain circumstances shall not be individually paid in the absence of a specific bid item for the work. The costs shall be included in the unit price bid for the storm sewer items, as indicated. Such items of work include but are not limited to:
1. Locating and connecting to an existing storm sewer, include in the price bid for storm sewer.
  2. The costs of furnishing bends, adapters, cutting and removing the existing storm sewer pipe, include in the price bid for storm sewer.
  3. Locating and connecting to an existing storm sewer service laterals, include in the price bid for service connections.
  4. Use of geotextile fabric to wrap pipe joints in lieu of using mastic, include in the price bid for storm sewer.
  5. Maintenance of an appropriate storm water outlet during construction, include in the price bid for storm sewer.
  6. The cost of all labor, equipment and materials necessary for testing of storm sewer, if required, included in the price bid for storm sewer.
  7. If a separate bid item for bypass pumping is NOT included in the Schedule of Unit Prices, providing temporary bypass pumping / control of storm water flows around the construction zone, include in the price bid for the associated sewer items.
  8. If the sewer is to be installed inside a casing pipe, furnishing and placing the carrier pipe, carrier pipe support materials, sand fill and grout seals, include in the unit price bid for sewer.
  9. Furnishing and installing underground utility location system, include in the price bid for sewer

### 1.3 SPECIFICATION REFERENCES

- A. The following Sections of this Project Manual as listed:
1. Section 33 05 06 "Trenching and Backfilling".
- B. ASTM D543 shall apply, except as modified herein.
- C. ASTM D1248 shall apply, except as modified herein.
- D. ASTM D1784 shall apply, except as modified herein.
- E. ASTM D3034 shall apply, except as modified herein.
- F. ASTM D3213 shall apply, except as modified herein.
- G. ASTM D3261 shall apply, except as modified herein.
- H. ASTM D3350 shall apply, except as modified herein.
- I. ASTM F679 shall apply, except as modified herein.
- J. ASTM F949 shall apply, except as modified herein.
- K. AWWA C900 shall apply, except as modified herein.
- L. AWWA C906 shall apply, except as modified herein.
- M. CEAM 2621 shall apply, except as modified herein.
- N. MnDOT 2503 shall apply, except as modified herein.
- O. MnDOT 2506 shall apply, except as modified herein.
- P. MnDOT 3236 shall apply, except as modified herein.

- Q. MnDOT 3245 shall apply, except as modified herein.
- R. MnDOT 3733 shall apply, except as modified herein.
- S. MnDOT Standard Plates Manual with latest revisions.
- T. State of Minnesota Plumbing Code shall apply to all underground pipe sewers installed through areas to be occupied by buildings. Unless noted otherwise, the provisions in this section are in addition to the referenced specification.

#### 1.4 SUBMITTALS

- A. Storm Sewer
  - 1. Manhole and catch basin structure - shop drawings.
  - 2. Manhole and catch basin casting - shop drawings.
  - 3. Piping and fittings - Certificates of Compliance.

### PART 2 - PRODUCTS

#### 2.1 OPEN CUT SEWER PIPE AND FITTINGS

- A. All storm sewer pipe shall be reinforced concrete pipe, unless otherwise shown on the plans.
- B. Reinforced Concrete Pipe (MnDOT 3236)
  - 1. Reinforced Concrete Pipe (RCP), fittings and specials shall conform with the requirements of MnDOT 3236 (Reinforced Concrete Pipe) for the type, size and strength class specified. The joints for RCP shall be rubber gasketed conforming to MnDOT Standard Plate 3006. Reinforced concrete pipe shall conform to the following strength class, unless otherwise shown on the plans or these specifications.
    - (a) 12-inch – Class IV
    - (b) 15-inch through 30-inch - Class III
- C. Solid Wall Polyvinyl Chloride (PVC) Pipe (MnDOT 3245) (Thermoplastic, TP)
  - 1. 4-inch through 15-inch Diameters: Smooth-walled polyvinyl chloride pipe and fittings shall conform with the requirements of ASTM D-3034 for the Standard Dimension Ratio (SDR) of 35.
  - 2. Over 15-inch Diameters: Smooth-walled polyvinyl chloride pipe and fittings shall conform with the requirements of ASTM F679 with a minimum wall thickness for a minimum pipe stiffness of 46.
  - 3. The connection shall be push-on with elastomeric gasketed joints, which are bonded to the inner walls of the gasket recess of the bell socket.
  - 4. The pipe grade used shall be resistant to aggressive soil and corrosive substances in accordance with the requirements of ASTM D543.
- D. Profile Wall Polyvinyl Chloride (PVC) Pipe
  - 1. Large diameter (21-inches through 48-inches) closed profile polyvinyl chloride pipe and fittings shall conform with the requirements of ASTM F794. Pipe and fittings shall be made from polyvinyl chloride compounds which comply with the requirements for a minimum cell classification of 12364A as defined by ASTM D1784.
  - 2. All joints shall be of the bell and spigot type with elastomeric seals and conform to the requirements of ASTM D3212. Gaskets shall be factory installed and chemically bonded to the bell end of the pipe
  - 3. Alternate PVC pipe conforming to Contech A-2000 (ASTM F949) will be accepted.
- E. Corrugated Polyethylene (CP) Pipe and Fittings (MnDOT 3247)

1. Smooth interior and corrugated exterior polyethylene pipe and fittings (diameters through 36-inches) shall conform to the requirements of AASHTO M294 or ASTM F2648 and MnDOT 3247. All joints shall be installed using an approved watertight sleeve with gaskets meeting the requirements of ASTM F477.

F. Flexible Pipe Jointing

1. Pipe and fitting joints for solid wall and profile wall polyvinyl chloride (PVC) pipe shall be in accordance with ASTM 3212. This includes the flexible elastomeric seals being rated at sustaining an internal pressure of 10.8 psi for 10 minutes.
2. Pipe and fitting joints for corrugated polyethylene pipe shall be in accordance with ASTM D3261-90.

G. Corrugated Aluminized Steel (CAS) Pipe, Type 2 - Smooth Interior Corrugated Exterior Pipe and Fittings (MnDOT 3222)

1. 72-inch diameter (between outlet control structure and existing 72-inch C.M.P): Pipe shall be formed from Aluminized Steel Type 2 coil (12 ga.) and conform to the current AASHTO M-274 and ASTM A819 material specification. Pipe shall be manufactured to conform to the current ASTM A760 Type 1R. Each pipe shall be fabricated with a minimum of two (2) annular corrugations to join the pipe with band connectors. Pipe shall be joined together with hugger band connectors made from the same material as the pipe. All joints shall be constructed with the hugger band drawn together by two (2) diameter bolts through the use of a bar and strap connector, or an angle type connector. All joints shall have two O-ring gaskets that conform to the requirements of ASTM C361 (Section 5.9).

H. Corrugated Steel (CS) Pipe (MnDOT 3226)

1. No exception to the referenced specification is made.

2.2 MANHOLES & CATCH BASINS

A. Precast Concrete Manholes and Catch Basin Section

1. Storm sewer manholes shall conform to the MnDOT Standard for the design type shown on the plans.
2. Reinforced polypropylene plastic steps shall be furnished for all storm sewer manholes 8.0-feet or more in depth.

B. Castings

1. All casting assemblies shall meet the certification requirements of the Minnesota Department of Transportation and be manufactured by a MnDOT approved source.
2. The Type of curb and gutter catch basin casting assembly to be used shall be Neenah R-3067-V (Vane Grate).
3. The type of non-street / rear yard inlet casting assembly to be used shall be Neenah R-4342 stool grate.

C. Adjusting Rings

1. Ladtech H.D.P.E. adjusting rings are approved as an alternate to concrete adjusting rings.

D. Chimney Seal

1. Chimney seals accepted for use, when shown in the plans, shall be one of the following listed as standard of quality:
  - (a) Infi-Shield (exterior only)
  - (b) Cretex (exterior or interior)

2.3 GEOTEXTILE FABRIC

- A. MnDOT 3733, Type I, non-woven for use in wrapping joints in storm sewer.



## SECTION 33 42 13 - STORMWATER CULVERTS

### PART 1 - GENERAL

#### 1.1 SUMMARY

- A. This section covers the furnishing of all labor, materials, tools, equipment and performances of all work and services necessary to construct pipe culverts as indicated on the drawings or as specified herein.

#### 1.2 METHOD OF MEASUREMENT AND PAYMENT

- A. Measurement and compensation for the following items shall be paid according to the referenced specification or as modified below:
  - 1. No exception to the referenced specification is made.
- B. The furnishing and installing of specific items and/or the performance of work under certain circumstances shall not be individually paid in the absence of a specific bid item for the work. The costs shall be included in the unit price bid for the associated pipe culvert items, as indicated. Such items of work include but are not limited to:
  - 1. The placement of clay borrow as an anti-seepage collar, include in the price bid for pipe culvert.
  - 2. Connection to an existing pipe culvert, storm sewer pipe or subdrain, include in the price bid for pipe culvert.
  - 3. Use of geotextile fabric to wrap pipe joints in lieu of using mastic, include in the price bid for storm sewer.
  - 4. Maintenance of an appropriate storm water outlet during construction, include in the price bid for pipe culvert.
  - 5. If the culvert is to be installed inside a casing pipe, furnishing and placing the carrier pipe, carrier pipe support materials, sand fill and grout seals, include in the unit price bid for culvert.
  - 6. The furnishing and installation of a trash guard shall be included in the price bid for RC Pipe Apron, as indicated in the details.
  - 7. The furnishing and installation of tie bolt fasteners to tie all pipe joints along the entire storm sewer culvert shall be included in the price bid for RC Pipe Sewer, as indicated in the details.

#### 1.3 SPECIFICATION REFERENCES

- A. Reference Section 33 05 06 "Trenching and Backfilling" of this Project Manual, except as modified herein.
- B. MnDOT 2501 shall apply to the construction of pipe culvert and appurtenance items, except as modified herein.
- C. Unless noted otherwise, the provisions in this section are in addition to the referenced specification.

#### 1.4 SUBMITTALS

- A. No submittals for this section.

### PART 2 - PRODUCTS

#### 2.1 CULVERT PIPE AND FITTINGS

- A. Reinforced Concrete Pipe (MnDOT 3236)
  - 1. No exception to the referenced specification is made.

### PART 3 - EXECUTION

3.1 CONSTRUCTION REQUIREMENTS

- A. The Contractor shall install a clay (or an approved impermeable equal) collar around all culverts at a point approximately 4.0-feet from each apron. The collar shall fill the breadth and height of the trench for a minimum length of 3.0- feet.

3.2 FIELD QUALITY CONTROL

- A. Deflection test - No exception to the referenced specification is made.
- B. Televising - No exception to the referenced specification is made.

**\*\*\*\*END OF SECTION\*\*\*\***

**SECTION 34 41 05 - TRAFFIC SIGNS AND DEVICES**

**PART 1 - GENERAL**

1.1 SUMMARY

- A. This section covers the furnishing of all labor, materials, tools equipment and performances of all work and services necessary or incidental to project signing as indicated on the drawings or as specified herein.

1.2 METHOD OF MEASUREMENT AND PAYMENT

- A. Measurement and compensation for the following items shall be paid according to the referenced specification or as modified below:
  - 1. Traffic Signs shall be paid at the unit price bid for related items and includes the cost of providing and installing the sign, sign posts, stringers, brackets, attachment angles or strap mounting hardware, and all other materials and labor required for sign installation per the plan details.
- B. The furnishing and installing specific items and/or the performance of work under certain circumstances shall not be individually paid in the absence of a specific bid item for the work. The costs shall be included in the unit price bid for the associated project signing item. Such items of work include but are not limited to:
  - 1. No exception to the referenced specification is made.

1.3 SPECIFICATION REFERENCES

- A. MnDOT 2564 - Traffic Signs and Devices.
- B. MnDOT 3401 -Flanged Channel Sign Posts.
- C. Current "Minnesota Manual for Uniform Traffic Control Devices" - <http://www.dot.state.mn.us/trafficeng/publ/mutcd/index.html>
- D. Unless noted otherwise, the provisions in this section are in addition to the referenced specification.

1.4 SUBMITTALS

- A. No submittals for this section.

**PART 2 - PRODUCTS (NOT USED)**

**PART 3 - EXECUTION (NOT USED)**

**\*\*\*\*\*END OF SECTION\*\*\*\*\***



# APPENDIX A

GEOTECHNICAL EVALUATION REPORT

# Geotechnical Evaluation Report

Vernon Avenue Improvements  
TH 13 to the Minnesota River  
Savage, Minnesota

*Prepared for*

## Lower Minnesota River Watershed District

### **Professional Certification:**

I hereby certify that this plan, specification, or report was prepared by me or under my direct supervision and that I am a duly Licensed Professional Engineer under the laws of the State of Minnesota.

Neil G. Lund, PE  
Technical Manager, Senior Engineer  
License Number: 46212  
August 2, 2023

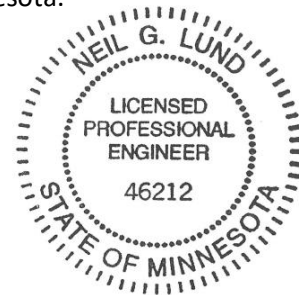

August 2, 2023

Project B2302291

Ms. Linda Loomis  
District Administrator  
Lower Minnesota River Watershed District  
112 E. 5th Street, #102  
Chaska, MN 55318

Re: Geotechnical Evaluation  
Vernon Avenue Improvements  
TH 13 to the Minnesota River  
Savage, Minnesota

Dear Ms. Loomis:

We are pleased to present this Geotechnical Evaluation Report for the proposed improvements to Vernon Avenue between Th 13 and the Minnesota River in Savage, Minnesota.

Thank you for making Braun Intertec your geotechnical consultant for this project. If you have questions about this report, or if there are other services that we can provide in support of our work to date, please contact Neil Lund at 952.995.2284 or ([nlund@braunintertec.com](mailto:nlund@braunintertec.com)).

Sincerely,

BRAUN INTERTEC CORPORATION



Neil G. Lund, PE  
Technical Manager, Senior Engineer



Brian J. Schreurs, PE  
Account Manager, Senior Engineer

# Table of Contents

Description	Page
A. Introduction.....	1
A.1. Project Description.....	1
A.2. Site Conditions.....	2
A.3. Purpose.....	2
A.4. Background Information and Reference Documents.....	2
A.5. Scope of Services.....	2
B. Results.....	3
B.1. Geologic Overview.....	3
B.2. Previous Geotechnical Information.....	4
B.3. Boring Results.....	4
B.4. Laboratory Test Results.....	5
B.5. Groundwater.....	5
C. Recommendations.....	5
C.1. Design and Construction Discussion.....	5
C.1.a. Pavement Reconstruction.....	5
C.1.b. Culvert Replacement.....	6
C.2. Pavements.....	6
C.2.a. Pavement Reclamation and Subgrade Preparation.....	6
C.2.b. Pavement Subgrade Test Roll.....	6
C.2.c. Engineered Fill Materials and Compaction.....	7
C.2.d. Pavement Design Sections.....	7
C.2.e. Pavement Materials Placement.....	8
C.3. Culvert Replacement.....	8
C.3.a. Excavated Slopes.....	8
C.3.b. Groundwater Control.....	9
C.3.c. Culvert Bedding and Subgrade Treatments.....	9
C.3.d. Additional Foundation Support and Bedding/Treatment Recommendations.....	10
C.3.e. Subgrade Fill Materials and Compaction.....	10
C.3.f. Permanent Side Slopes.....	10
D. Procedures.....	10
D.1. Penetration Test Borings.....	10
D.2. Log of Boring Sheets.....	11
D.3. Material Classification and Testing.....	11
D.3.a. Visual and Manual Classification.....	11
D.3.b. Laboratory Testing.....	11
D.4. Groundwater Measurements.....	11
E. Qualifications.....	12
E.1. Variations in Subsurface Conditions.....	12
E.1.a. Material Strata.....	12
E.1.b. Groundwater Levels.....	12
E.2. Continuity of Professional Responsibility.....	12
E.2.a. Plan Review.....	12
E.2.b. Construction Observations and Testing.....	13
E.3. Use of Report.....	13
E.4. Standard of Care.....	13



## Table of Contents (continued)

### **Appendix**

Soil Boring Location Sketch

Log of Boring Sheets C-1, R-1 to R-4

Descriptive Terminology of Soil

## A. Introduction

### A.1. Project Description

This Geotechnical Evaluation Report addresses the proposed reconstruction of Vernon Avenue between TH 13 and the Minnesota River in the City of Savage, approximately 0.7 miles in length. This segment of Vernon Avenue provides access to the Cargill East River Dredge Site, and the Lower Minnesota River Watershed District (LMRWD) is seeking to reconstruct the pavement to support these dredging activities. This will include replacement of a centerline culvert below the access road to the dredging site. We provide a summary of project details below in Table 1.

**Table 1. Project Description**

Project Component	Description	Source
Pavement rehabilitation methods	Reconstruction	Bolton & Menk, Inc.
New pavement type(s)	Bituminous	Bolton & Menk, Inc.
Pavement loads	200,000 Bituminous ESALs*	Assumed; infrequent or intermittent loaded truck traffic for dredging activities
Grade changes	Limited (< 2 feet)	Assumed
Existing culvert to be replaced	48-inch RCP with flared aprons and trash guards Invert depth unknown	Bolton & Menk, Inc.

\*Equivalent 18,000-lb single axle loads based on 20-year design. See attachment to this report for calculation.

We have described our understanding of the proposed construction and site to the extent others reported it to us. Depending on the extent of available information, we may have made assumptions based on our experience with similar projects. If we have not correctly recorded or interpreted the project details, the project team should notify us. New or changed information could require additional evaluation, analyses and/or recommendations.

## **A.2. Site Conditions**

Vernon Avenue has a flat, single-lane rural roadway profile within the project corridor, with limited ditches. Given the location within the Minnesota River Valley, the road is subject to regular seasonal flooding.

Pavement history or construction plans were not available for our review. Based on historical aerial photographs, it appears the dredge site was first constructed around 2008.

## **A.3. Purpose**

The purpose of our geotechnical evaluation was to characterize subsurface geologic conditions at selected exploration locations, evaluate their impact, and provide geotechnical recommendations for the design and construction of the Vernon Avenue Improvements project.

## **A.4. Background Information and Reference Documents**

We reviewed the following information:

- Communications with LMRWD and Bolton & Menk, Inc. regarding the proposed project.
- *Report of Pavement Evaluation Services* prepared by American Engineering Testing, Inc. (AET) dated June 25, 2015.
- Aerial imagery of the site available on Google Earth.
- Geologic map *C-17 Geologic Atlas of Scott County, Minnesota* prepared by the Minnesota Geological Survey and dated 2006.

## **A.5. Scope of Services**

We performed our scope of services for the project in accordance with our proposal QTB173917 to Ms. Linda Loomis of the Lower Minnesota River Watershed District (LMRWD), which we prepared at the request of Mr. Brad Fisher of Bolton & Menk, Inc. The following list describes the geotechnical tasks completed in accordance with our authorized scope of services.

- Reviewing the background information and reference documents previously cited.

- Staking and clearing the exploration location of underground utilities. We selected and staked the new exploration locations. We acquired the surface elevations and locations with GPS technology using the State of Minnesota's permanent GPS base station network. The Soil Boring Location Sketch included in the Appendix shows the approximate locations of the borings.
- Obtaining a right-of-way permit from the City of Savage.
- Performing four standard penetration test (SPT) borings to a depth of 6 feet for the roadway, with sampling on a continuous basis.
- Performing one SPT boring for the culvert to a depth of 14 1/2 feet, with sampling at 2 1/2-foot intervals.
- Preparing this report containing a boring location sketch, logs of soil borings, a summary of the soils encountered, results of laboratory tests, and recommendations subgrade preparation, pavement design and culvert replacement.

Our scope of services did not include environmental services or testing, and we did not train the personnel performing this evaluation to provide environmental services or testing. We can provide these services or testing if requested.

## **B. Results**

### **B.1. Geologic Overview**

Based on the review of geologic map C-17 Geologic Atlas of Scott County, the project site is underlain by Minnesota River alluvium with deposits of low-lying windblown sand near the riverbanks.

We based the geologic origins used in this report on the soil types and laboratory testing, and available common knowledge of the geological history of the site. Because of the complex depositional history, geologic origins can be difficult to ascertain. We did not perform a detailed investigation of the geologic history for the site.

## B.2. Previous Geotechnical Information

The AET report included several evaluation services including soil borings to 3 1/2 feet deep, pavement cores, falling weight deflectometer (FWD) testing, ground penetrating radar (GPR) testing, and digital pavement surface condition rating.

The report indicated Vernon Avenue had significant distresses at the surface, with cores, GPR and borings showing about 2 1/2 inches of damaged bituminous pavement material overlying around 6 to 8 inches of mixed aggregate base material. The report classified the underlying soils as clayey fill, buried topsoil and clayey and sandy alluvium, with FWD testing indicating a rather weak subgrade R-value of 5.6.

Based on the results of the evaluation, the report recommended reclaiming 4 inches of roadway and placing 3 inches of Class 1 aggregate surfacing to support hauling operations proposed for that time.

## B.3. Boring Results

Table 2 provides a summary of the soil boring results in the general order we encountered the strata. Please refer to the Log of Boring sheets in the Appendix for additional details. The Descriptive Terminology of Soil sheet in the Appendix includes definitions of abbreviations used in Table 2. For simplicity in this report, we define fill to mean existing, uncontrolled, or undocumented fill.

**Table 3. Subsurface Profile Summary\***

Strata	Soil Type - ASTM Classification	Range of Penetration Resistances	Commentary and Details
Pavement section	---	---	<ul style="list-style-type: none"> <li>Appeared as multi-layered aggregate; the top material consisted of highly deteriorated bituminous pavement mixed with floodplain sediment, which was then underlain by an apparent aggregate base</li> <li>Surface materials ranged from 2 to 6 inches thick, with the underlying aggregate ranging between 6 and 12 inches and generally about 8 inches thick</li> </ul>
Fill	SP-SM, SM	About 20 to 32 blows per foot (BPF)	<ul style="list-style-type: none"> <li>Present in Borings C-1, R-1 and R-3</li> <li>Primarily fine to medium-grained and moist.</li> <li>Some penetration test results influenced by frost.</li> </ul>
Swamp deposit	OL	4 BPF	<ul style="list-style-type: none"> <li>Organic clay mixed with peat from 2 to 4 feet in Boring R-1</li> </ul>
Alluvium	GP, SP, SM, SC, CL, ML	3 to 22 BPF	<ul style="list-style-type: none"> <li>Loose sandy soils or soft to medium clays and silts</li> <li>Extended to boring termination depth at each location</li> </ul>

## **B.4. Laboratory Test Results**

We performed moisture content (MC) tests (ASTM D2216), wash loss (P200) tests (ASTM D1140), and organic content (OC) (ASTM D2974) on selected samples to verify field classification and to evaluate the reusability of the material. The Log of Boring Sheets attached in the Appendix show the results of moisture content and wash loss testing we performed next to the tested sample depth.

## **B.5. Groundwater**

We did not observe groundwater while performing our borings. Groundwater may take days or longer to reach equilibrium in the boreholes and we immediately backfilled the boreholes in accordance with our scope of work. If the project team identifies a need for more accurate determination of groundwater depth, we can install piezometers. We expect groundwater will fluctuate with nearby Minnesota River levels and project planning should anticipate seasonal and annual fluctuations of groundwater.

## **C. Recommendations**

### **C.1. Design and Construction Discussion**

#### **C.1.a. Pavement Reconstruction**

We understand LMRWD is proposing to reconstruct Vernon Avenue to support future hauling operations. The proposed reconstruction will include a new bituminous surface.

Given the nature of the pavement materials we encountered, which often appeared to be inconsistent in quality and thickness and mixed with floodplain soils and other materials, we do not recommend reusing any reclaimed pavements as aggregate base. Instead, these materials should be removed and replaced with a quality imported aggregate capable of supporting new pavements and the associated haul route loading.

The pavement subgrades are likely to consist of soft or sensitive materials that will be prone to strength loss during construction. In particular, we noted organic clay just below the surface at Boring R-1, shallow sandy silt in Boring R-4, and alluvial clays in other locations. These materials will provide poor support to reconstructed pavements and portions of these soils should be removed and replaced with imported granular subbase to improve uniformity of the pavement section, aid in constructability, and reduce the potential for pavement damage from frost heave and saturated subgrade conditions.

Section C.2 includes our detailed recommendations for pavement reconstruction.

### **C.1.b. Culvert Replacement**

We assume the culvert will be ground supported and will be replaced by open-cut methods.

Boring C-1 generally encountered alluvial soils including silty sand and clayey sand; at depth, these soils were considered to be soft to medium in consistency. These soils can generally be reused to support the replacement culvert, though there is a somewhat high risk of these soils being wet upon exposure and becoming unstable, which will require further subcutting and/or soil conditioning. Additionally, groundwater control during construction will need to be considered.

Our recommendations for culvert construction are provided in Section C.3.

## **C.2. Pavements**

### **C.2.a. Pavement Reclamation and Subgrade Preparation**

We recommend the following steps for pavement reclamation and subgrade preparation for Vernon Avenue, understanding the new pavements will generally match existing grades.

- Remove the pavement by reclamation or excavation. We do not recommend using reclaimed pavement materials as aggregate base in the new pavements.
- Cut the roadway section to grade and have a geotechnical representative observe the excavated subgrade or top of reclaim material to evaluate if additional improvements are necessary.
- Scarify, moisture condition, and surface compact the subgrade to at least 100 percent of Standard Proctor density.
- Also, where necessary: place pavement engineered fill to grade where required and compact in accordance with Section C.2.c to bottom of the pavement section.
- Test roll the pavement subgrades and aggregate base layers as described in Section C.2.b.

### **C.2.b. Pavement Subgrade Test Roll**

After preparing the subgrade as described above and prior to the placement of the sand subbase or additional aggregate base, we recommend test rolling the subgrade soils with a fully loaded tandem-axle truck. We also recommend having a geotechnical representative observe the test roll. Areas that fail the test roll indicate soft or weak soils that will require additional correction work to support pavements.

We recommend test rolling in accordance with MnDOT Specification 2111. Where necessary to correct subgrades that fail the test roll, options include moisture conditioning and recompaction, subcutting and replacement with soil or crushed aggregate, chemical stabilization and/or geotextiles.

**C.2.c. Engineered Fill Materials and Compaction**

The on-site soils with an organic content less than 5 percent and free of debris are suitable for reuse as backfill. The fine-grained soils will be more difficult to compact if wet, allowed to become wet, or if spread and compacted over wet surfaces. Soils comprised substantially of silt (ML), such as those in Boring R-4, will usually not be suitable for reuse and should be replaced.

If imported material is to be used, Table 4 contains our recommendations for engineered fill.

**Table 4. Recommended Fill and Compaction Specifications\***

Material	Material Specification	Compaction Specification
Subgrade fill	Select grading material (MnDOT 2106.2.B.1)	MnDOT 2106.3.G.1
Below landscaped surfaces, where subsidence is not a concern	Non-structural embankment (MnDOT 2106.2.B.8)	MnDOT 2106.3.G.2

\*More select soils may be needed to accommodate work occurring in periods of wet or freezing weather.

We recommend spreading engineered fill in loose lifts of approximately 12 inches thick. We recommend moisture conditioning and compacting engineered fill in accordance with the MnDOT specifications listed in the table above. The project documents should not allow the contractor to use frozen material as engineered fill or to place engineered fill on frozen material.

We recommend performing moisture content and density tests in engineered fill to evaluate if the contractors are effectively moisture conditioning and compacting the soil and meeting project requirements.

**C.2.d. Pavement Design Sections**

Our scope of services for this project did not include laboratory tests on subgrade soils to determine an R-value for pavement design. The previous report cited an R-value of 5.6 based on FWD testing. This R-value represents in-situ subgrade stiffness; assuming poorer subgrade soils will be subcut and the soils generally will be recompacted, we recommend a design R-value of 10.



Based upon the estimated traffic loads and above R-value, we recommend a new pavement section per the following table.

**Table 5. Recommended Bituminous Pavement Thickness Design**

Layer	Thickness (in)	Material (Specification)
Bituminous wear course	4	SPWEA340C (MnDOT 2360)
Aggregate base	8	Class 5 (MnDOT 3138)
Granular subbase	12	Select granular material (MnDOT 3149.2.B.2)

The above pavement design is based upon a 20-year performance life. This is the amount of time before major rehabilitation is anticipated. This performance life assumes maintenance such as seal coating and crack sealing is routinely performed. The actual pavement life will vary depending on variations in weather, traffic conditions, and maintenance.

Many conditions affect the overall performance of the pavements. Some of these conditions include the environment, loading conditions, and the level of ongoing maintenance. With regard to bituminous pavements, in particular, it is common to have thermal cracking develop within the first few years of placement and continue throughout the life of the pavement. We recommend developing a regular maintenance plan for filling cracks in pavements to lessen the potential impacts for cold weather distress due to frost heave or warm weather distress due to wetting and softening of the subgrade.

### **C.2.e. Pavement Materials Placement**

We recommend placing the bituminous wear course to meet the requirements of MnDOT Specification 2360. We recommend compacting the aggregate base to meet the requirements of MnDOT Specification 2211.3.D.2.c (Penetration Index Method for the dynamic cone penetrometer [DCP]).

## **C.3. Culvert Replacement**

### **C.3.a. Excavated Slopes**

Based on the borings, we anticipate on-site soils in excavations will consist of soils meeting OSHA (Occupational Safety and Health Administration) Type C requirements. OSHA guidelines indicate unsupported excavations in Type C soils should have a gradient no steeper than 1:1.5 V:H

(vertical :horizontal). Slopes constructed in this manner may still exhibit surface sloughing. In organic soils or excavations below the groundwater table, excavation sides slopes may need to lie back at even flatter inclinations for stability. OSHA requires an engineer to evaluate slopes or excavations over 20 feet in depth.

An OSHA-approved qualified person should review the soil classification in the field. Excavations must comply with the requirements of OSHA 29 CFR, Part 1926, Subpart P, "Excavations and Trenches." This document states excavation safety is the responsibility of the contractor. The project specifications should reference these OSHA requirements.

### C.3.b. Groundwater Control

Prior to excavation and installation of the new culverts, we recommend temporarily diverting waters away from the construction area. Temporary groundwater removal may be required to facilitate the construction of the culvert and perform any necessary soil corrections below the structures. We anticipate local dewatering can be achieved with sump pumps.

### C.3.c. Culvert Bedding and Subgrade Treatments

Our recommendation for culvert bedding, taken from MnDOT standard plans, is shown in Figure 1

**Figure 1. Standard Culvert Bedding for Rigid Pipe (without treatment)**

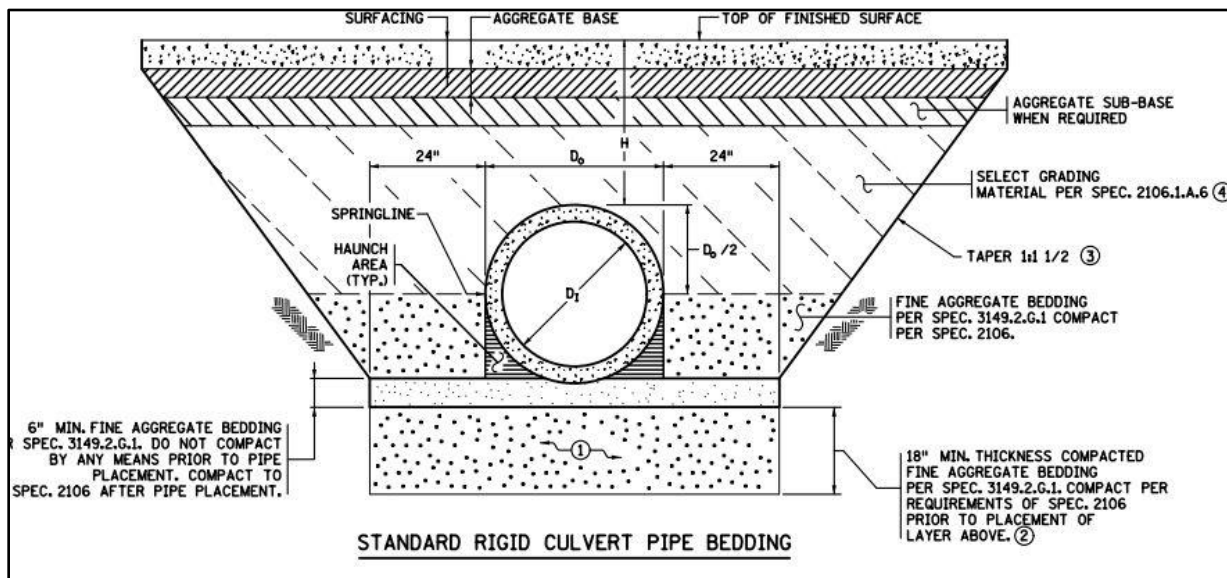

<sup>1</sup>Figure taken from MnDOT's Standard Plan 5-297-441.

### **C.3.d. Additional Foundation Support and Bedding/Treatment Recommendations**

We recommend stripping vegetation, topsoil, debris, soft, loose, or poor soils encountered to the bottom of the bedding material elevation in accordance with MnDOT Specifications 2106 and 2451. We define poor soils as organic, soft or loose soils judged unsuitable for support of the culvert structures.

A geotechnical engineer should evaluate the site to judge if further excavation is warranted. Poor soils will typically require removal to a depth of at least 2 feet and replacement with additional bedding material.

### **C.3.e. Subgrade Fill Materials and Compaction**

We recommend culvert backfill per the details shown above in Figure 1. If working in wet conditions, the fine aggregate bedding material can be replaced with coarse aggregate bedding to aid in compaction.

We recommend performing density tests in engineered fill to evaluate if the contractors are effectively compacting the soil and meeting project requirements. We recommend spreading engineered fill in loose lifts of approximately 12 inches thick or less. The project documents should not allow the contractor to use frozen material as engineered fill or to place engineered fill on frozen material. Frost should not penetrate under foundations during construction.

We recommend compacting backfill and fill per the MnDOT Standard Specification and the criteria presented in the table below.

### **C.3.f. Permanent Side Slopes**

Our scope of services did not include global stability of the permanent side slopes. We recommend constructing these slopes at a 1:3 V:H inclination or flatter. Steeper slopes should be reviewed and may require additional analyses.

## **D. Procedures**

### **D.1. Penetration Test Borings**

We drilled the penetration test borings with a Geoprobe rig equipped with hollow-stem auger. We performed the borings in general accordance with ASTM D6151 taking penetration test samples at 2 1/2- or 5-foot intervals in general accordance with ASTM D1586. We collected thin-walled tube samples in general accordance with ASTM D1587 at selected depths. The boring logs show the actual sample intervals and corresponding depths.

## **D.2. Log of Boring Sheets**

The Appendix includes Log of Boring sheets for our penetration test borings. The logs identify and describe the penetrated geologic materials and present the results of penetration resistance tests performed. The logs also present the results of laboratory tests performed on penetration test samples, and groundwater measurements.

We inferred strata boundaries from changes in the penetration test samples and the auger cuttings. The strata boundary depths are only approximate. The boundary depths likely vary away from the boring locations, and the boundaries themselves may occur as gradual rather than abrupt transitions.

## **D.3. Material Classification and Testing**

### **D.3.a. Visual and Manual Classification**

We visually and manually classified the geologic materials encountered based on ASTM D2488. When we performed laboratory classification tests, we used the results to classify the geologic materials in accordance with ASTM D2487. The Appendix includes a chart explaining the classification system we used.

### **D.3.b. Laboratory Testing**

The exploration logs in the Appendix note the results of the laboratory tests performed on geologic material samples. We performed the tests in general accordance with ASTM or AASHTO procedures.

## **D.4. Groundwater Measurements**

The drillers checked for groundwater while advancing the penetration test borings, and again after auger withdrawal. We then filled the boreholes or allowed them to remain open for an extended period of observation, as noted on the boring logs.

## **E. Qualifications**

### **E.1. Variations in Subsurface Conditions**

#### **E.1.a. Material Strata**

We developed our evaluation, analyses, and recommendations from a limited amount of site and subsurface information. It is not standard engineering practice to retrieve material samples from exploration locations continuously with depth. Therefore, we must infer strata boundaries and thicknesses to some extent. Strata boundaries may also be gradual transitions, and project planning should expect the strata to vary in depth, elevation, and thickness away from the exploration locations.

Variations in subsurface conditions present between exploration locations may not be revealed until performing additional exploration work or starting construction. If future activity for this project reveals any such variations, you should notify us so that we may reevaluate our recommendations. Such variations could increase construction costs, and we recommend including a contingency to accommodate them.

#### **E.1.b. Groundwater Levels**

We made groundwater measurements under the conditions reported herein and shown on the exploration logs and interpreted in the text of this report. Note that the observation periods were relatively short, and project planning can expect groundwater levels to fluctuate in response to rainfall, flooding, irrigation, seasonal freezing and thawing, surface drainage modifications, and other seasonal and annual factors.

### **E.2. Continuity of Professional Responsibility**

#### **E.2.a. Plan Review**

We based this report on a limited amount of information, and we made a number of assumptions to help us develop our recommendations. We should be retained to review the geotechnical aspects of the designs and specifications. This review will allow us to evaluate whether we anticipated the design correctly, if any design changes affect the validity of our recommendations, and if the design and specifications correctly interpret and implement our recommendations.

### **E.2.b. Construction Observations and Testing**

We recommend retaining us to perform the required observations and testing during construction as part of the ongoing geotechnical evaluation. This will allow us to correlate the subsurface conditions exposed during construction with those encountered by the borings and provide professional continuity from the design phase to the construction phase. If we do not perform observations and testing during construction, it becomes the responsibility of others to validate the assumption made during the preparation of this report and to accept the construction-related geotechnical engineer-of-record responsibilities.

### **E.3. Use of Report**

This report is for the exclusive use of the addressed parties. Without written approval, we assume no responsibility to other parties regarding this report. Our evaluation, analyses, and recommendations may not be appropriate for other parties or projects.

### **E.4. Standard of Care**

In performing its services, Braun Intertec used that degree of care and skill ordinarily exercised under similar circumstances by reputable members of its profession currently practicing in the same locality. No warranty, express or implied, is made.

## Appendix

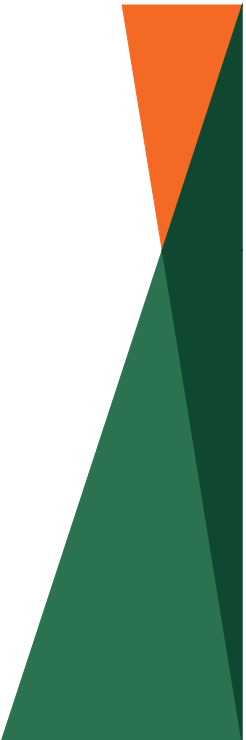

Drawing Information

Project No:	B2302291
Drawing No:	B2302291
Drawn By:	JAG
Date Drawn:	3/22/23
Checked By:	NGL
Last Modified:	5/2/23



Project Information

Vernon Avenue  
Improvements  
and Access Road  
Culvert Project

Vernon Avenue, TH 13  
to the Minnesota River

Savage, Minnesota

Soil Boring  
Location Sketch

-  DENOTES APPROXIMATE LOCATION OF ROADWAY SPT SOIL BORING
-  DENOTES APPROXIMATE LOCATION OF CULVERT SPT SOIL BORING



150' 0 300'

SCALE: 1"= 300'



See Descriptive Terminology sheet for explanation of abbreviations

<b>Project Number B2302291</b>					<b>BORING: C-1</b>		
<b>Geotechnical Evaluation</b>					LOCATION: See attached sketch		
<b>Vernon Ave Improvements and Access Road Culvert</b>					DATUM: NAD 1983 HARN Adj MN Scott (US Feet)		
<b>Vernon Ave TH 13 to Minnesota River</b>					NORTHING: 215572	EASTING: 491414	
<b>Savage, Minnesota</b>					START DATE: 03/29/23	END DATE: 03/29/23	
DRILLER: M. Barber		LOGGED BY: N. Lund		SURFACING: Gravel Road		WEATHER: Partly Cloudy	
SURFACE ELEVATION: 706.8 ft		RIG: GP-1		METHOD: 3 1/4" HSA			
Elev./ Depth ft	Water Level	Description of Materials (Soil-ASTM D2488 or 2487; Rock-USACE EM 1110-1-2908)	Sample	Blows (N-Value) Recovery	q <sub>p</sub> tsf	MC %	Tests or Remarks
706.5 0.3		GRAVEL, 4 inches aggregate surface					
705.5 1.3		APPARENT AGGREGATE BASE, 12 inches aggregate base					
702.8 4.0		FILL: SILTY SAND (SM), fine-grained, brown, frozen (moist when thawed)	5	16-14-14 (28) 12"		11	P200=14%
		SILTY SAND (SM), fine-grained, brown, moist, medium dense (ALLUVIUM)		10-9-8 (17) 12"			
				9-7-6 (13) 10"			
695.8 11.0			10	2-2-1 (3) 16"			
		CLAYEY SAND (SC), with Sand, gray, moist, soft to medium (ALLUVIUM)		2-3-3-3 (6) 12"		24	P200=46%
692.3 14.5		END OF BORING	15				Water not observed while drilling.
		Boring then backfilled with auger cuttings					
			20				
			25				
			30				

See Descriptive Terminology sheet for explanation of abbreviations

<b>Project Number B2302291</b>				<b>BORING: R-1</b>	
<b>Geotechnical Evaluation</b>				LOCATION: See attached sketch	
<b>Vernon Ave Improvements and Access Road Culvert</b>				DATUM: NAD 1983 HARN Adj MN Scott (US Feet)	
<b>Vernon Ave TH 13 to Minnesota River</b>				NORTHING: 212514	EASTING: 491377
DRILLER: M. Barber		LOGGED BY: N. Lund		START DATE: 03/29/23	END DATE: 03/29/23
SURFACE ELEVATION: 712.0 ft	RIG: GP-1	METHOD: 3 1/4" HSA	SURFACING: Gravel Road		WEATHER: Partly Cloudy

Elev./Depth ft	Water Level	Description of Materials (Soil-ASTM D2488 or 2487; Rock-USACE EM 1110-1-2908)	Sample	Blows (N-Value) Recovery	q <sub>p</sub> tsf	MC %	Tests or Remarks
711.5		GRAVEL, 6 inches aggregate surface		50-18-13-19			
0.5		APPARENT AGGREGATE BASE, 8 inches aggregate base		(31) 16"			
710.8							
1.2		FILL: POORLY GRADED SAND with SILT (SP-SM), fine to medium-grained, black and brown, moist		4-2-2-2 (4) 16"		80	OC=15%
710.0							
2.0							
708.0		ORGANIC CLAY (OL), intermixed with Peat, black, moist (SWAMP DEPOSIT)	5	3-8-14-21 (22) 12"			
4.0							
706.0		POORLY GRADED GRAVEL (GP), fine to coarse-grained, Clay inclusions, tan, moist, medium dense (ALLUVIUM)					Water not observed while drilling.
6.0		END OF BORING					
		Boring then backfilled with auger cuttings					
			10				
			15				
			20				
			25				
			30				

See Descriptive Terminology sheet for explanation of abbreviations

<b>Project Number B2302291</b>				<b>BORING: R-2</b>	
<b>Geotechnical Evaluation</b>				LOCATION: See attached sketch	
<b>Vernon Ave Improvements and Access Road Culvert</b>				DATUM: NAD 1983 HARN Adj MN Scott (US Feet)	
<b>Vernon Ave TH 13 to Minnesota River</b>				NORTHING: 213433	EASTING: 491393
DRILLER: M. Barber		LOGGED BY: N. Lund		START DATE: 03/29/23	END DATE: 03/29/23
SURFACE ELEVATION: 710.3 ft	RIG: GP-1	METHOD: 3 1/4" HSA	SURFACING: Gravel Road		WEATHER: Partly Cloudy

Elev./ Depth ft	Water Level	Description of Materials (Soil-ASTM D2488 or 2487; Rock-USACE EM 1110-1-2908)	Sample	Blows (N-Value) Recovery	q <sub>p</sub> tsf	MC %	Tests or Remarks
710.0		GRAVEL, 4 inches aggregate surface		16-6-5-4			OC=3% Water not observed while drilling.
0.3		APPARENT AGGREGATE BASE, 8 inches		(11)			
709.3		apparent aggregate base		16"			
1.0		POORLY GRADED SAND (SP), fine-grained,		2-2-2-4			
708.3		dark brown, moist, loose (ALLUVIUM)		(4)			
2.0		LEAN CLAY (CL), with Sand, brown and gray,		12"			
706.3		moist, medium (ALLUVIUM)		3-4-3-4			
4.0		LEAN CLAY (CL), with Sand, slightly organic,	5	(7)		17	
704.3		black, moist, medium (ALLUVIUM)		12"			
6.0		END OF BORING					
		Boring then backfilled with auger cuttings					
			10				
			15				
			20				
			25				
			30				



See Descriptive Terminology sheet for explanation of abbreviations

<b>Project Number B2302291</b>				<b>BORING: R-4</b>	
<b>Geotechnical Evaluation</b>				LOCATION: See attached sketch	
<b>Vernon Ave Improvements and Access Road Culvert</b>				DATUM: NAD 1983 HARN Adj MN Scott (US Feet)	
<b>Vernon Ave TH 13 to Minnesota River</b>				NORTHING: 215191	EASTING: 491425
DRILLER: M. Barber		LOGGED BY: N. Lund		START DATE: 03/29/23	END DATE: 03/29/23
SURFACE ELEVATION: 709.8 ft	RIG: GP-1	METHOD: 3 1/4" HSA	SURFACING: Gravel Road		WEATHER: Partly Cloudy

Elev./ Depth ft	Water Level	Description of Materials (Soil-ASTM D2488 or 2487; Rock-USACE EM 1110-1-2908)	Sample	Blows (N-Value) Recovery	q <sub>p</sub> tsf	MC %	Tests or Remarks
709.7		GRAVEL, 2 inches aggregate surface		44-10-6-7			
0.1		APPARENT AGGREGATE BASE, 6 inches		(16)		19	Hydrometer And Sieve Analysis
709.1		apparent aggregate base		16"			
0.7		SANDY SILT (ML), dark brown, moist, loose		1-2-3-5			
707.8		(ALLUVIUM)		(5)			
2.0		LEAN CLAY (CL), with Sand, brown, moist, medium (ALLUVIUM)		12"			
			5	2-3-3-4		29	
703.8				(6)			
6.0		END OF BORING		10"			Water not observed while drilling.
		Boring then backfilled with auger cuttings					

Criteria for Assigning Group Symbols and Group Names Using Laboratory Tests <sup>A</sup>				Soil Classification		
				Group Symbol	Group Name <sup>B</sup>	
Coarse-grained Soils (more than 50% retained on No. 200 sieve)	Gravels (More than 50% of coarse fraction retained on No. 4 sieve)	Clean Gravels (Less than 5% fines <sup>C</sup> )	$C_u \geq 4$ and $1 \leq C_c \leq 3^D$	GW	Well-graded gravel <sup>E</sup>	
			$C_u < 4$ and/or ( $C_c < 1$ or $C_c > 3$ ) <sup>D</sup>	GP	Poorly graded gravel <sup>E</sup>	
		Gravels with Fines (More than 12% fines <sup>C</sup> )	Fines classify as ML or MH	GM	Silty gravel <sup>EFG</sup>	
			Fines Classify as CL or CH	GC	Clayey gravel <sup>EFG</sup>	
	Sands (50% or more coarse fraction passes No. 4 sieve)	Clean Sands (Less than 5% fines <sup>H</sup> )	$C_u \geq 6$ and $1 \leq C_c \leq 3^D$	SW	Well-graded sand <sup>I</sup>	
			$C_u < 6$ and/or ( $C_c < 1$ or $C_c > 3$ ) <sup>D</sup>	SP	Poorly graded sand <sup>I</sup>	
		Sands with Fines (More than 12% fines <sup>H</sup> )	Fines classify as ML or MH	SM	Silty sand <sup>FGI</sup>	
			Fines classify as CL or CH	SC	Clayey sand <sup>FGI</sup>	
Fine-grained Soils (50% or more passes the No. 200 sieve)	Silts and Clays (Liquid limit less than 50)	Inorganic	PI > 7 and plots on or above "A" line <sup>J</sup>	CL	Lean clay <sup>KLM</sup>	
			PI < 4 or plots below "A" line <sup>J</sup>	ML	Silt <sup>KLM</sup>	
		Organic	Liquid Limit – oven dried	<0.75	OL	Organic clay <sup>KLMN</sup>
			Liquid Limit – not dried		OH	Organic silt <sup>KLMQ</sup>
	Silts and Clays (Liquid limit 50 or more)	Inorganic	PI plots on or above "A" line	CH	Fat clay <sup>KLM</sup>	
			PI plots below "A" line	MH	Elastic silt <sup>KLM</sup>	
		Organic	Liquid Limit – oven dried	<0.75	OH	Organic clay <sup>KLMQ</sup>
			Liquid Limit – not dried		OH	Organic silt <sup>KLMQ</sup>
Highly Organic Soils	Primarily organic matter, dark in color, and organic odor			PT	Peat	

- A. Based on the material passing the 3-inch (75-mm) sieve.
- B. If field sample contained cobbles or boulders, or both, add "with cobbles or boulders, or both" to group name.
- C. Gravels with 5 to 12% fines require dual symbols:  
GW-GM well-graded gravel with silt  
GW-GC well-graded gravel with clay  
GP-GM poorly graded gravel with silt  
GP-GC poorly graded gravel with clay
- D.  $C_u = D_{60} / D_{10}$        $C_c = (D_{30})^2 / (D_{10} \times D_{60})$
- E. If soil contains  $\geq 15\%$  sand, add "with sand" to group name.
- F. If fines classify as CL-ML, use dual symbol GC-GM or SC-SM.
- G. If fines are organic, add "with organic fines" to group name.
- H. Sands with 5 to 12% fines require dual symbols:  
SW-SM well-graded sand with silt  
SW-SC well-graded sand with clay  
SP-SM poorly graded sand with silt  
SP-SC poorly graded sand with clay
- I. If soil contains  $\geq 15\%$  gravel, add "with gravel" to group name.
- J. If Atterberg limits plot in hatched area, soil is CL-ML, silty clay.
- K. If soil contains 15 to < 30% plus No. 200, add "with sand" or "with gravel", whichever is predominant.
- L. If soil contains  $\geq 30\%$  plus No. 200, predominantly sand, add "sandy" to group name.
- M. If soil contains  $\geq 30\%$  plus No. 200 predominantly gravel, add "gravelly" to group name.
- N. PI  $\geq 4$  and plots on or above "A" line.
- O. PI < 4 or plots below "A" line.
- P. PI plots on or above "A" line.
- Q. PI plots below "A" line.

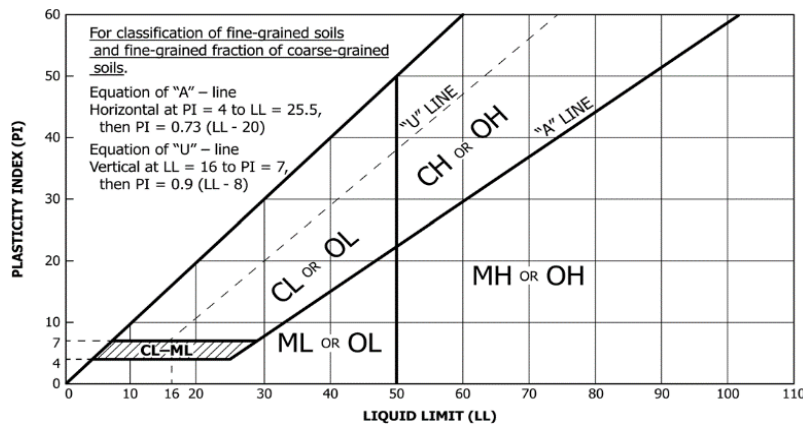

Laboratory Tests			
DD	Dry density, pcf	$q_p$	Pocket penetrometer strength, tsf
WD	Wet density, pcf	$q_u$	Unconfined compression test, tsf
P200	% Passing #200 sieve	LL	Liquid limit
MC	Moisture content, %	PL	Plastic limit
OC	Organic content, %	PI	Plasticity index

**Particle Size Identification**

- Boulders..... over 12"
- Cobbles..... 3" to 12"
- Gravel  
Coarse..... 3/4" to 3" (19.00 mm to 75.00 mm)  
Fine..... No. 4 to 3/4" (4.75 mm to 19.00 mm)
- Sand  
Coarse..... No. 10 to No. 4 (2.00 mm to 4.75 mm)  
Medium..... No. 40 to No. 10 (0.425 mm to 2.00 mm)  
Fine..... No. 200 to No. 40 (0.075 mm to 0.425 mm)
- Silt..... No. 200 (0.075 mm) to .005 mm
- Clay..... < .005 mm

**Relative Proportions<sup>L-M</sup>**

- trace..... 0 to 5%
- little..... 6 to 14%
- with.....  $\geq 15\%$

**Inclusion Thicknesses**

- lens..... 0 to 1/8"
- seam..... 1/8" to 1"
- layer..... over 1"

**Apparent Relative Density of Cohesionless Soils**

- Very loose ..... 0 to 4 BPF
- Loose ..... 5 to 10 BPF
- Medium dense..... 11 to 30 BPF
- Dense..... 31 to 50 BPF
- Very dense..... over 50 BPF

**Consistency of Cohesive Soils      Blows Per Foot      Approximate Unconfined Compressive Strength**

- Very soft..... 0 to 1 BPF..... < 0.25 tsf
- Soft..... 2 to 4 BPF..... 0.25 to 0.5 tsf
- Medium..... 5 to 8 BPF..... 0.5 to 1 tsf
- Stiff..... 9 to 15 BPF..... 1 to 2 tsf
- Very Stiff..... 16 to 30 BPF..... 2 to 4 tsf
- Hard..... over 30 BPF..... > 4 tsf

**Moisture Content:**

- Dry:** Absence of moisture, dusty, dry to the touch.
- Moist:** Damp but no visible water.
- Wet:** Visible free water, usually soil is below water table.

**Drilling Notes:**

**Blows/N-value:** Blows indicate the driving resistance recorded for each 6-inch interval. The reported N-value is the blows per foot recorded by summing the second and third interval in accordance with the Standard Penetration Test, ASTM D1586.

**Partial Penetration:** If the sampler could not be driven through a full 6-inch interval, the number of blows for that partial penetration is shown as #/x" (i.e. 50/2"). The N-value is reported as "REF" indicating refusal.

**Recovery:** Indicates the inches of sample recovered from the sampled interval. For a standard penetration test, full recovery is 18", and is 24" for a thinwall/shelby tube sample.

**WOH:** Indicates the sampler penetrated soil under weight of hammer and rods alone; driving not required.

**WOR:** Indicates the sampler penetrated soil under weight of rods alone; hammer weight and driving not required.

**Water Level:** Indicates the water level measured by the drillers either while drilling ( ), at the end of drilling ( ), or at some time after drilling ( ).

**Sample Symbols**

	Standard Penetration Test		Rock Core
	Modified California (MC)		Thinwall (TW)/Shelby Tube (SH)
	Auger		Texas Cone Penetrometer
	Grab Sample		Dynamic Cone Penetrometer

# APPENDIX B

## WORK IN UP RAILROAD ROW ASSOCIATED DOCUMENTS

Maintenance Consent Letter

Contractor Endorsement

General Terms and Conditions for Contractor Endorsement

Exhibit A - Insurance Provisions for Contractor Endorsement

Exhibit B – Minimum Safety Requirements for Contractor Endorsement

Permit Record Summary

REMS Project: 0793829  
Agency Project: OT1.129866  
Start Date: 11/10/2023  
End Date: 11/10/2024



BUILDING AMERICA®

### Maintenance Consent Letter

DOT	MP	Subdivision
854259H	19.246	Mankato Sub

Linda Loomis  
LOWER MINNESOTA RIVER WATERSHED DISTRICT  
6677 Olson Memorial Highway  
Golden Valley, MN 55427

It is the LOWER MINNESOTA RIVER WATERSHED DISTRICT’s (**Public Entity**) intention to repair subgrade, remove existing pavement, install asphalt pavement, replace existing pavement markings, and provide traffic control (**Work**) at the location(s) noted above. This letter serves as an acceptance by UNION PACIFIC RAILROAD COMPANY (**Railroad**) of the proposed Work to be performed.

If a contractor is to do any of the Work on Railroad’s property, then the Public Entity shall require its contractor to execute and return the attached Contractor Endorsement (**Endorsement**). Under no circumstances will Public Entity’s contractor be allowed on Railroad’s property without first executing the Endorsement.

This Consent Letter shall be valid for one year or until the Work is completed or this Consent Letter is revoked by the Railroad.

Prior to performing the Work, Contractor agrees to provide forty-five (45) days advance notice to the Railroad Representative identified below.

**Leo Craig (817) 901-9560 – lcraig@olsson.com**

**Fiber Optics & Telecommunications (Call Before You Dig) – [www.up.com/CBUD](http://www.up.com/CBUD)**

DocuSigned by:  
  
C56FA18B005E4A2...

11/30/2023

Melinda S DuBay  
Manager I  
Engineering-Public Projects



**REMS Project:** 0793829  
**Agency Project:** OT1.129866  
**Consent Start Date:** 11/10/2023

## Contractor Endorsement

DOT	MP	Subdivision
854259H	19.246	Mankato Sub

A. As a condition to entering upon Union Pacific Railroad Company (**Railroad**) property to repair subgrade, remove existing pavement, install asphalt pavement, replace existing pavement markings, and provide traffic control (**Work**) described in the Consent Letter, the contractor for LOWER MINNESOTA RIVER WATERSHED DISTRICT (**Public Entity**), by signing below, acknowledges and agrees to comply with and be bound by the Railroad Property Access Training (UP-PAT) and the General Terms and Provisions of the Endorsement that can be found at the links below.

**Union Pacific Property Access Training (UP-PAT)**

[www.up.com/up-pat](http://www.up.com/up-pat)

**Contractor Endorsement-General Terms and Provisions**

[www.up.com/ce-terms](http://www.up.com/ce-terms)

**Third-party Flagging Requirements**

[www.up.com/flagging](http://www.up.com/flagging)

B. Upon request, all insurance documentation shall be provided to Railroad.

C. Fiber optics and telecommunication facilities can be present on Railroad property. Prior to performing work that has the potential to impact these facilities, the Agency or its contractor shall follow the procedures outlined on the Railroad webpage link below.

**Fiber Optics & Telecommunications (Call Before You Dig) - [www.up.com/CBUD](http://www.up.com/CBUD)**

D. Prior to Performing the Work, Contractor agrees to provide forty-five (45) days advance notice to the Railroad Representative identified below.

**Leo Craig (817) 901-9560 – [lcraig@olsson.com](mailto:lcraig@olsson.com)**

E. The terms of this Endorsement shall commence on the date of execution and continue for one (1) year or until such time as contractor has completed the Work. The Work may be terminated within 24 hours' notice by either party.

Signed Contractor Endorsement must be returned to the address below. No work may proceed until the terms of this endorsement have been met, and the executed endorsement and \$1,025 administrative fee is received.

Union Pacific Railroad Company  
 ATTN: Engineering-Public Projects  
 Maintenance Program  
 1400 Douglas Street MS910  
 Omaha, NE 68179

**REMS Project:** 0793829  
**Agency Project:** OT1.129866  
**Consent Start Date:** 11/10/2023

Payment of the \$1,025 administrative fee must be submitted using one of the methods identified on the Bill included with this endorsement. If paying by check, submit the Bill with the check and mail to the Bank of America address on the Bill. For ACH or wire transfer payments, refer to the instructions provided on the Bill.

**Failure to include the Bill Number with the payment will result in delays.**

<b>Company Name</b>			
<b>Contact Name</b>			
<b>Address</b>			
<b>City, ST Zip</b>			
<b>Phone</b>	<b>Email</b>		
<b>Contact Signature</b>			<b>Date</b>
<b>Payment Method</b> Select Payment Type	<input type="checkbox"/> <b>Check</b>	<input type="checkbox"/> <b>ACH</b>	<input type="checkbox"/> <b>Wire Transfer</b>

**Union Pacific Railroad Company**

BUILDING AMERICA™

**Bill Number** 329665161  
**Contract Number** 0793829  
**Audit Number** 311466  
**Customer Number** 57655  
**Folder Number**  
**Bill Date** 11/8/2023

**LOWER MINNESOTA RIVER WATERSHED DISTRICT**  
**6677 OLSON MEMORIAL HIGHWAY**  
**GOLDEN VALLEY, MN 55427**

For questions or comments please email [REBILLING@up.com](mailto:REBILLING@up.com)

**Bill Description :** Agency No: Vernon Ave (0T1.129866); DOT 854259H; Maintenance-Roadway. Effective date: 11/08/23

**Location of Agreement:** SAVAGE, MN

**Primary Purpose of Agreement:**

Description	Period		Amount
	From	To	
Roadway-Contractor's ROE Fee	11/8/2023	11/8/2023	\$1,025.00
<b>Total Due:</b>			<b>\$1,025.00</b>

.....  
**To assure proper credit to your account,  
 please remit payment using one of these methods:**

**ACH/Wire Information:**

Union Pacific Acct nbr: 3752021457 (Checking)

Wire XFER ABA Routing nbr: 026009593

ACH PYMT ABA Routing nbr: 111000012

**SEND Checks to:**

Union Pacific Railroad Company

12567 Collections Center Drive

Chicago, IL 60693

**Remittance Information:**

**Bill Number** 329665161

**Audit Number** 311466

**Customer Number** 57655

**Folder Number**

**Payable Upon Receipt: \$1,025.00**

**Receiving Bank's Address**

Bank of America

901 Main Street

Dallas, TX 75202

DUNS nbr: 00-699-1590

SWIFT Code: BOFAUS3N

Tax ID: 94-6001323

Network ID: 0136400825

# **CONTRACTOR ENDORSEMENT**

## **GENERAL TERMS AND PROVISIONS**

### **SECTION 1. DEFINITION OF CONTRACTOR.**

For purposes of this agreement, all references in this agreement to Contractor shall include Contractor's contractors, subcontractors, officers, agents and employees, and others acting under its or their authority. For purposes of clarity, Contractor agrees that any CIC (defined below) hired by Contractor is a subcontractor of Contractor and therefore included in the defined term Contractor pursuant to the foregoing sentence.

### **SECTION 2. ALL EXPENSES TO BE BORNE BY CONTRACTOR; SUPERVISION.**

A. Contractor shall bear any and all costs and expenses associated with any work performed by Contractor (including without limitation any CIC), or any costs or expenses incurred by Railroad relating to this agreement.

B. Contractor, at its own expense, shall adequately police and supervise all work to be performed by Contractor and shall ensure that such work is performed in a safe manner as set forth in SECTION 15. The responsibility of Contractor for safe conduct and adequate policing and supervision of Contractor's work shall not be lessened or otherwise affected by Railroad's approval of plans and specifications involving the work, or by Railroad's collaboration in performance of any work, or by the presence at the work site of a Railroad Representative, or by compliance by Contractor with any requests or recommendations made by Railroad Representative.

### **SECTION 3. TERM; TERMINATION.**

A. These general terms and provisions shall remain in effect for the term as stated in the Contractor Endorsement. Contractor agrees to notify the Railroad Representative in writing when it has completed its work on Railroad's property.

B. This agreement may be terminated by either party on twenty four (24) hours written notice to the other party.

### **SECTION 4. INSURANCE.**

A. Contractor will, upon request, provide Railroad with the (i) insurance binders, policies, certificates and endorsements set forth in **Exhibit A** of this agreement, and (ii) the insurance endorsements obtained by each subcontractor as required under SECTION 21 of this agreement.

B. Upon request, all insurance correspondence, binders, policies, certificates and endorsements shall be sent to:

Union Pacific Railroad Company  
Attn: Public Projects Manager  
1400 Douglas Street, STOP 1690  
Omaha, NE 68179

### **SECTION 5. PRECONSTRUCTION MEETING.**

If the work to be performed by the Contractor will involve the Railroad providing any flagging protection (or if a CIC is approved to provide flagging protection pursuant to the terms set forth herein) and/or there is separate work to be performed by the Railroad, the Contractor confirms that no work shall commence until the Railroad and Contractor

participate in a preconstruction meeting involving flagging procedures and coordination of work activities of the Contractor and the Railroad (and any CIC, as applicable.)

**SECTION 6. DISMISSAL OF CONTRACTOR'S EMPLOYEE.**

At the request of Railroad, Contractor shall remove from Railroad's property any employee of Contractor who fails to conform to the instructions of the Railroad Representative in connection with the work on Railroad's property, and any right of Contractor shall be suspended until such removal has occurred. Contractor shall indemnify Railroad against any claims arising from the removal of any such employee from Railroad's property.

**SECTION 7. CROSSINGS; COMPLIANCE WITH MUTCD AND FRA GUIDELINES.**

A. No additional vehicular crossings (including temporary haul roads) or pedestrian crossings over Railroad's trackage shall be installed or used by Contractor without the prior written permission of Railroad.

B. Any permanent or temporary changes, including temporary traffic control, to crossings must conform to the Manual of Uniform Traffic Control Devices (MUTCD) and any applicable Federal Railroad Administration rules, regulations and guidelines, and must be reviewed by the Railroad prior to any changes being implemented. In the event the Railroad is found to be out of compliance with federal safety regulations due to the Contractor's modifications, negligence, or any other reason arising from the Contractor's presence on the Railroad's property, the Contractor agrees to assume liability for any civil penalties imposed upon the Railroad for such noncompliance.

**SECTION 8. EXPLOSIVES.**

Explosives or other highly flammable substances shall not be stored or used on Railroad's property without the prior written approval of Railroad.

**SECTION 9. NOTICE OF COMMENCEMENT OF WORK - RAILROAD FLAGGING - PRIVATE FLAGGING.**

A. Contractor agrees to notify the Railroad Representative at least ten (10) working days in advance of Contractor commencing its work and at least thirty (30) working days in advance of proposed performance of any work by Contractor in which any person or equipment will be within twenty-five (25) feet of any track, or will be near enough to any track that any equipment extension (such as, but not limited to, a crane boom) will reach to within twenty-five (25) feet of any track.

B. No work of any kind shall be performed, and no person, equipment, machinery, tool(s), material(s), vehicle(s), or thing(s) shall be located, operated, placed, or stored within twenty-five (25) feet of any of Railroad's track(s) at any time, for any reason, unless and until a Railroad approved flagman is provided to watch for trains. Upon receipt of such thirty (30)-day notice, the Railroad Representative will determine and inform Contractor whether a flagman need be present and whether Contractor needs to implement any special protective or safety measures.

C. Contractor shall be permitted to hire a private contractor to perform flagging or other special protective or safety measures (such private contractor being commonly known in the railroad industry as a contractor-in-charge ("CIC")) in lieu of Railroad providing such services or in concert with Railroad providing such services, subject to prior written approval by Railroad, which approval shall be in Railroad's sole and absolute discretion. If Railroad agrees to permit Contractor to utilize a CIC pursuant to the preceding sentence, Contractor shall obtain Railroad's prior approval in writing for each of the following items, as determined in all respects in Railroad's sole and absolute discretion: (i) the identity of the third-party performing the role of CIC; (ii) the scope of the services to be performed for the project by the approved CIC; and (iii) any other terms and conditions governing such services to be provided by the CIC. If flagging or other special protective or safety measures are performed by an approved CIC, Contractor shall be solely responsible for (and shall timely pay such CIC for) its services. Railroad reserves the right to rescind any approval pursuant to this Subsection C., in whole or in part, at any time, as determined in Railroad's sole and absolute discretion.

D. If any flagging or other special protective or safety measures are performed by employees of Railroad and/or any contractor of Railroad, Railroad will bill Contractor for such expenses incurred by Railroad, unless Railroad and a federal, state or local governmental entity have agreed that Railroad is to bill such expenses to the federal, state or local

governmental entity. If Railroad will be sending the bills to Contractor, Contractor shall pay such bills within thirty (30) days of Contractor's receipt of billing.

E. If any flagging or other special protective or safety measures are performed by Railroad or a CIC, Contractor agrees that Contractor is not relieved of any of its responsibilities or liabilities set forth in this agreement.

F. The provisions set forth in this subsection are only applicable for Flagging Services performed by employees of Railroad: the rate of pay per hour for each flagman will be the prevailing hourly rate in effect for an eight-hour day for the class of flagmen used during regularly assigned hours and overtime in accordance with labor agreements and schedules in effect at the time the work is performed. In addition to the cost of such labor, a composite charge for vacation, holiday, health and welfare, supplemental sickness, Railroad Retirement and unemployment compensation, supplemental pension, Employees Liability and Property Damage and Administration will be included, computed on actual payroll. The composite charge will be the prevailing composite charge in effect at the time the work is performed. One and one-half times the current hourly rate is paid for overtime, Saturdays and Sundays, and two and one-half times current hourly rate for holidays. Wage rates are subject to change, at any time, by law or by agreement between Railroad and its employees, and may be retroactive as a result of negotiations or a ruling of an authorized governmental agency. Additional charges on labor are also subject to change. If the wage rate or additional charges are changed, Contractor (or the governmental entity, as applicable) shall pay on the basis of the new rates and charges. If flagging is performed by Railroad, reimbursement to Railroad will be required covering the full eight-hour day during which any flagman is furnished, unless the flagman can be assigned to other Railroad work during a portion of such day, in which event reimbursement will not be required for the portion of the day during which the flagman is engaged in other Railroad work. Reimbursement will also be required for any day not actually worked by the flagman following the flagman's assignment to work on the project for which Railroad is required to pay the flagman and which could not reasonably be avoided by Railroad by assignment of such flagman to other work, even though Contractor may not be working during such time. When it becomes necessary for Railroad to bulletin and assign an employee to a flagging position in compliance with union collective bargaining agreements, Contractor must provide Railroad a minimum of five (5) days notice prior to the cessation of the need for a flagman. If five (5) days notice of cessation is not given, Contractor will still be required to pay flagging charges for the five (5) day notice period required by union agreement to be given to the employee, even though flagging is not required for that period. An additional thirty (30) days notice must then be given to Railroad if flagging services are needed again after such five day cessation notice has been given to Railroad.

#### **SECTION 10. LIMITATION AND SUBORDINATION OF RIGHTS GRANTED.**

A. The foregoing grant of right is subject and subordinate to the prior and continuing right and obligation of the Railroad to use and maintain its entire property including the right and power of Railroad to construct, maintain, repair, renew, use, operate, change, modify or relocate railroad tracks, roadways, signal, communication, fiber optics, or other wirelines, pipelines and other facilities upon, along or across any or all parts of its property, all or any of which may be freely done at any time or times by Railroad without liability to Contractor or to any other party for compensation or damages.

B. The foregoing grant is also subject to all outstanding superior rights (whether recorded or unrecorded and including those in favor of licensees and lessees of Railroad's property, and others) and the right of Railroad to renew and extend the same, and is made without covenant of title or for quiet enjoyment.

#### **SECTION 11. NO INTERFERENCE WITH OPERATIONS OF RAILROAD AND ITS TENANTS.**

A. Contractor shall conduct its operations so as not to interfere with the continuous and uninterrupted use and operation of the railroad tracks and property of Railroad, including without limitation, the operations of Railroad's lessees, licensees or others, unless specifically authorized in advance by the Railroad Representative. Nothing shall be done or permitted to be done by Contractor at any time that would in any manner impair the safety of such operations. When not in use, Contractor's machinery and materials shall be kept at least fifty (50) feet from the centerline of Railroad's nearest track, and there shall be no vehicular crossings of Railroads tracks except at existing open public crossings.

B. Operations of Railroad and work performed by Railroad personnel and delays in the work to be performed by Contractor caused by such railroad operations and work are expected by Contractor, and Contractor agrees that Railroad shall have no liability to Contractor, or any other person or entity for any such delays. The Contractor shall

coordinate its activities with those of Railroad and third parties so as to avoid interference with railroad operations. The safe operation of Railroad train movements and other activities by Railroad takes precedence over any work to be performed by Contractor.

**SECTION 12. LIENS.**

Contractor shall pay in full all persons who perform labor or provide materials for the work to be performed by Contractor. Contractor shall not create, permit or suffer any mechanic's or materialmen's liens of any kind or nature to be created or enforced against any property of Railroad for any such work performed. Contractor shall indemnify and hold harmless Railroad from and against any and all liens, claims, demands, costs or expenses of whatsoever nature in any way connected with or growing out of such work done, labor performed, or materials furnished. If Contractor fails to promptly cause any lien to be released of record, Railroad may, at its election, discharge the lien or claim of lien at Contractor's expense.

**SECTION 13. PROTECTION OF FIBER OPTIC CABLE SYSTEMS.**

A. Fiber optic cable systems may be buried on Railroad's property. Protection of the fiber optic cable systems is of extreme importance since any break could disrupt service to users resulting in business interruption and loss of revenue and profits. Contractor shall telephone Railroad during normal business hours (7:00 a.m. to 9:00 p.m. Central Time, Monday through Friday, except holidays) at 1-800-336-9193 (also a 24-hour, 7-day number for emergency calls) to determine if fiber optic cable is buried anywhere on Railroad's property to be used by Contractor. If it is, Contractor will telephone the telecommunications company(ies) involved, make arrangements for a cable locator and, if applicable, for relocation or other protection of the fiber optic cable. Contractor shall not commence any work until all such protection or relocation (if applicable) has been accomplished.

**B. IN ADDITION TO OTHER INDEMNITY PROVISIONS IN THIS AGREEMENT, CONTRACTOR SHALL INDEMNIFY, DEFEND AND HOLD RAILROAD HARMLESS FROM AND AGAINST ALL COSTS, LIABILITY AND EXPENSE WHATSOEVER (INCLUDING, WITHOUT LIMITATION, ATTORNEYS' FEES, COURT COSTS AND EXPENSES) ARISING OUT OF ANY ACT OR OMISSION OF CONTRACTOR, ITS AGENTS AND/OR EMPLOYEES, THAT CAUSES OR CONTRIBUTES TO (1) ANY DAMAGE TO OR DESTRUCTION OF ANY TELECOMMUNICATIONS SYSTEM ON RAILROAD'S PROPERTY, AND/OR (2) ANY INJURY TO OR DEATH OF ANY PERSON EMPLOYED BY OR ON BEHALF OF ANY TELECOMMUNICATIONS COMPANY, AND/OR ITS CONTRACTOR, AGENTS AND/OR EMPLOYEES, ON RAILROAD'S PROPERTY. CONTRACTOR SHALL NOT HAVE OR SEEK RECOURSE AGAINST RAILROAD FOR ANY CLAIM OR CAUSE OF ACTION FOR ALLEGED LOSS OF PROFITS OR REVENUE OR LOSS OF SERVICE OR OTHER CONSEQUENTIAL DAMAGE TO A TELECOMMUNICATION COMPANY USING RAILROAD'S PROPERTY OR A CUSTOMER OR USER OF SERVICES OF THE FIBER OPTIC CABLE ON RAILROAD'S PROPERTY.**

**SECTION 14. PERMITS - COMPLIANCE WITH LAWS.**

In the prosecution of the work covered by this agreement, Contractor shall secure any and all necessary permits and shall comply with all applicable federal, state and local laws, regulations and enactments affecting the work including, without limitation, all applicable Federal Railroad Administration regulations.

**SECTION 15. SAFETY.**

A. Safety of personnel, property, rail operations and the public is of paramount importance in the prosecution of the work performed by Contractor. Contractor shall be responsible for initiating, maintaining and supervising all safety, operations and programs in connection with the work. Contractor shall at a minimum comply with Railroad's safety standards listed in **Exhibit B**, hereto attached, to ensure uniformity with the safety standards followed by Railroad's own forces. As a part of Contractor's safety responsibilities, Contractor shall notify Railroad if Contractor determines that any of Railroad's safety standards are contrary to good safety practices. Contractor shall furnish copies of **Exhibit B** to each of its employees before they enter the job site.

B. Without limitation of the provisions of paragraph A above, Contractor shall keep the job site free from safety and health hazards and ensure that its employees are competent and adequately trained in all safety and health aspects of the job.

C. Contractor shall have proper first aid supplies available on the job site so that prompt first aid services may be provided to any person injured on the job site. Contractor shall promptly notify Railroad of any U.S. Occupational Safety and Health Administration reportable injuries. Contractor shall have a nondelegable duty to control its employees while they are on the job site or any other property of Railroad, and to be certain they do not use, be under the influence of, or have in their possession any alcoholic beverage, drug or other substance that may inhibit the safe performance of any work.

D. If and when requested by Railroad, Contractor shall deliver to Railroad a copy of Contractor's safety plan for conducting the work (the "Safety Plan"). Railroad shall have the right, but not the obligation, to require Contractor to correct any deficiencies in the Safety Plan. The terms of this agreement shall control if there are any inconsistencies between this agreement and the Safety Plan.

#### **SECTION 16. INDEMNITY.**

A. TO THE EXTENT NOT PROHIBITED BY APPLICABLE STATUTE, CONTRACTOR SHALL INDEMNIFY, DEFEND AND HOLD HARMLESS RAILROAD, ITS AFFILIATES, AND ITS AND THEIR OFFICERS, AGENTS AND EMPLOYEES (INDIVIDUALLY AN "INDEMNIFIED PARTY" OR COLLECTIVELY "INDEMNIFIED PARTIES") FROM AND AGAINST ANY AND ALL LOSS, DAMAGE, INJURY, LIABILITY, CLAIM, DEMAND, COST OR EXPENSE (INCLUDING, WITHOUT LIMITATION, ATTORNEY'S, CONSULTANT'S AND EXPERT'S FEES, AND COURT COSTS), FINE OR PENALTY (COLLECTIVELY, "LOSS") INCURRED BY ANY PERSON (INCLUDING, WITHOUT LIMITATION, ANY INDEMNIFIED PARTY, CONTRACTOR, OR ANY EMPLOYEE OF CONTRACTOR OR OF ANY INDEMNIFIED PARTY) ARISING OUT OF OR IN ANY MANNER CONNECTED WITH (I) ANY WORK PERFORMED BY CONTRACTOR, OR (II) ANY ACT OR OMISSION OF CONTRACTOR, ITS OFFICERS, AGENTS OR EMPLOYEES, OR (III) ANY BREACH OF THIS AGREEMENT BY CONTRACTOR.

B. THE RIGHT TO INDEMNITY UNDER THIS SECTION SHALL ACCRUE UPON OCCURRENCE OF THE EVENT GIVING RISE TO THE LOSS, AND SHALL APPLY REGARDLESS OF ANY NEGLIGENCE OR STRICT LIABILITY OF ANY INDEMNIFIED PARTY, EXCEPT WHERE THE LOSS IS CAUSED BY THE SOLE ACTIVE NEGLIGENCE OF AN INDEMNIFIED PARTY AS ESTABLISHED BY THE FINAL JUDGMENT OF A COURT OF COMPETENT JURISDICTION. THE SOLE ACTIVE NEGLIGENCE OF ANY INDEMNIFIED PARTY SHALL NOT BAR THE RECOVERY OF ANY OTHER INDEMNIFIED PARTY.

C. CONTRACTOR EXPRESSLY AND SPECIFICALLY ASSUMES POTENTIAL LIABILITY UNDER THIS SECTION FOR CLAIMS OR ACTIONS BROUGHT BY CONTRACTOR'S OWN EMPLOYEES. CONTRACTOR WAIVES ANY IMMUNITY IT MAY HAVE UNDER WORKER'S COMPENSATION OR INDUSTRIAL INSURANCE ACTS TO INDEMNIFY THE INDEMNIFIED PARTIES UNDER THIS SECTION. CONTRACTOR ACKNOWLEDGES THAT THIS WAIVER WAS MUTUALLY NEGOTIATED BY THE PARTIES HERETO.

D. NO COURT OR JURY FINDINGS IN ANY EMPLOYEE'S SUIT PURSUANT TO ANY WORKER'S COMPENSATION ACT OR THE FEDERAL EMPLOYERS' LIABILITY ACT AGAINST A PARTY TO THIS AGREEMENT MAY BE RELIED UPON OR USED BY CONTRACTOR IN ANY ATTEMPT TO ASSERT LIABILITY AGAINST ANY INDEMNIFIED PARTY.

E. THE PROVISIONS OF THIS SECTION SHALL SURVIVE THE COMPLETION OF ANY WORK PERFORMED BY CONTRACTOR OR THE TERMINATION OR EXPIRATION OF THIS AGREEMENT. IN NO EVENT SHALL THIS SECTION OR ANY OTHER PROVISION OF THIS AGREEMENT BE DEEMED TO LIMIT ANY LIABILITY CONTRACTOR MAY HAVE TO ANY INDEMNIFIED PARTY BY STATUTE OR UNDER COMMON LAW.



**SECTION 17. RESTORATION OF PROPERTY.**

In the event Railroad authorizes Contractor to take down any fence of Railroad or in any manner move or disturb any of the other property of Railroad in connection with the work to be performed by Contractor, then in that event Contractor shall, as soon as possible and at Contractor's sole expense, restore such fence and other property to the same condition as the same were in before such fence was taken down or such other property was moved or disturbed. Contractor shall remove all of Contractor's tools, equipment, rubbish and other materials from Railroad's property promptly upon completion of the work, restoring Railroad's property to the same state and condition as when Contractor entered thereon.

**SECTION 18. WAIVER OF DEFAULT.**

Waiver by Railroad of any breach or default of any condition, covenant or agreement herein contained to be kept, observed and performed by Contractor shall in no way impair the right of Railroad to avail itself of any remedy for any subsequent breach or default.

**SECTION 19. MODIFICATION - ENTIRE AGREEMENT.**

No modification of this agreement shall be effective unless made in writing and signed by Contractor and Railroad. This agreement and the exhibits attached hereto and made a part hereof constitute the entire understanding between Contractor and Railroad and cancel and supersede any prior negotiations, understandings or agreements, whether written or oral, with respect to the work to be performed by Contractor.

**SECTION 20. ASSIGNMENT.**

Contractor shall not assign or subcontract this agreement, or any interest therein, without the written consent of the Railroad.

**SECTION 21. SUBCONTRACTING.**

Contractor shall be responsible for the acts and omissions of all subcontractors. Before Contractor commences any work, the Contractor shall, except to the extent prohibited by law; (1) require each of its subcontractors to include the Contractor as "Additional Insured" on the subcontractor's Commercial General Liability policy and Umbrella or Excess policies (if applicable) with respect to all liabilities arising out of the subcontractor's performance of work on behalf of the Contractor by endorsing these policies with ISO Additional Insured Endorsements CG 20 10, and CG 20 37 (or substitute forms providing equivalent coverage; (2) require each of its subcontractors to endorse their Commercial General Liability Policy with "Contractual Liability Railroads" ISO Form CG 24 17 10 01 (or a substitute form providing equivalent coverage) for the job site; and (3) require each of its subcontractors to endorse their Business Automobile Policy with "Coverage For Certain Operations In Connection With Railroads" ISO Form CA 20 70 10 01 (or a substitute form providing equivalent coverage) for the job site.

# **EXHIBIT A**

## **TO GENERAL TERMS AND CONDITIONS OF THE CONTRACTOR'S ENDORSEMENT**

### **INSURANCE PROVISIONS FOR CONTRACTOR ENDORSEMENT**

Contractor shall, at its sole cost and expense, procure and maintain during the course of the project and until all project Work on Railroad's property has been completed and the Contractor has removed all equipment and materials from Railroad's property and has cleaned and restored Railroad's property to Railroad's satisfaction, the following insurance coverage:

- A. Commercial General Liability insurance.** Commercial general liability (CGL) with a limit of not less than \$5,000,000 each occurrence and an aggregate limit of not less than \$10,000,000. CGL insurance must be written on ISO occurrence form CG 00 01 12 04 (or a substitute form providing equivalent coverage).

The policy must also contain the following endorsement, which must be stated on the certificate of insurance:

- Contractual Liability Railroads ISO form CG 24 17 10 01 (or a substitute form providing equivalent coverage) showing "Union Pacific Railroad Company Property" as the Designated Job Site.
- Designated Construction Project(s) General Aggregate Limit ISO Form CG 25 03 03 97 (or a substitute form providing equivalent coverage) showing the project on the form schedule.

- B. Business Automobile Coverage insurance.** Business auto coverage written on ISO form CA 00 01 10 01 (or a substitute form providing equivalent liability coverage) with a combined single limit of not less \$5,000,000 for each accident and coverage must include liability arising out of any auto (including owned, hired and non-owned autos).

The policy must contain the following endorsements, which must be stated on the certificate of insurance:

- Coverage For Certain Operations In Connection With Railroads ISO form CA 20 70 10 01 (or a substitute form providing equivalent coverage) showing "Union Pacific Property" as the Designated Job Site.
- Motor Carrier Act Endorsement - Hazardous materials clean up (MCS-90) if required by law.

- C. Workers' Compensation and Employers' Liability insurance.** Coverage must include but not be limited to:
- Contractor's statutory liability under the workers' compensation laws of the state where the work is being performed.
  - Employers' Liability (Part B) with limits of at least \$500,000 each accident, \$500,000 disease policy limit \$500,000 each employee.

If Contractor is self-insured, upon request, evidence of state approval and excess workers compensation coverage must be provided. Coverage must include liability arising out of the U. S. Longshoremen's and Harbor Workers' Act, the Jones Act, and the Outer Continental Shelf Land Act, if applicable.

- D. Railroad Protective Liability insurance.** Contractor must maintain "Railroad Protective Liability" (RPL) insurance written on ISO occurrence form CG 00 35 12 04 (or a substitute form providing equivalent coverage) on behalf of Railroad as named insured, with a limit of not less than \$2,000,000 per occurrence and an aggregate of \$6,000,000. The definition of "JOB LOCATION" and "WORK" on the declaration page of the policy shall refer to this agreement and shall describe all WORK or OPERATIONS performed under this agreement. Contractor shall provide this agreement to Contractor's insurance agent(s) and/or broker(s) and Contractor shall instruct such agent(s) and/or broker(s) to procure the insurance coverage required by this agreement. UPON REQUEST, A BINDER STATING THE POLICY IS IN PLACE MUST BE SUBMITTED TO RAILROAD BEFORE THE WORK MAY COMMENCE AND UNTIL THE ORIGINAL POLICY IS FORWARDED TO UNION PACIFIC RAILROAD.

- E. **Umbrella or Excess** insurance. If Contractor utilizes umbrella or excess policies, these policies must "follow form" and afford no less coverage than the primary policy.
- F. **Pollution Liability** insurance. Pollution liability coverage must be included when the scope of the work as defined in the agreement includes installation, temporary storage, or disposal of any "hazardous" material that is injurious in or upon land, the atmosphere, or any watercourses; or may cause bodily injury at any time.

If required, coverage may be provided in separate policy form or by endorsement to Contractors CGL or RPL. Any form coverage must be equivalent to that provided in ISO form CG 24 15 "Limited Pollution Liability Extension Endorsement" or CG 28 31 "Pollution Exclusion Amendment" with limits of at least \$5,000,000 per occurrence and an aggregate limit of \$10,000,000.

If the scope of work as defined in this agreement includes the disposal of any hazardous or non-hazardous materials from the job site, upon request, Contractor must furnish to Railroad evidence of pollution legal liability insurance maintained by the disposal site operator for losses arising from the insured facility accepting the materials, with coverage in minimum amounts of \$1,000,000 per loss, and an annual aggregate of \$2,000,000.

### **Other Requirements**

- G. All policy(ies) required above (except business automobile, worker's compensation and employers liability) must include Railroad as "Additional Insured" using ISO Additional Insured Endorsements CG 20 10, and CG 20 37 (or substitute forms providing equivalent coverage). The coverage provided to Railroad as additional insured shall not be limited by Contractor's liability under the indemnity provisions of this agreement. BOTH CONTRACTOR AND RAILROAD EXPECT THAT UNION PACIFIC RAILROAD COMPANY WILL BE PROVIDED WITH THE BROADEST POSSIBLE COVERAGE AVAILABLE BY OPERATION OF LAW UNDER ISO ADDITIONAL INSURED FORMS CG 20 10 AND CG 20 37.
- H. Punitive damages exclusion, if any, must be deleted (and the deletion indicated on the certificate of insurance), unless (a) insurance coverage may not lawfully be obtained for any punitive damages that may arise under this agreement, or (b) all punitive damages are prohibited by all states in which this agreement will be performed.
- I. Contractor waives all rights of recovery, and its insurers also waive all rights of subrogation of damages against Railroad and its agents, officers, directors and employees for damages covered by the workers compensation and employers liability or commercial umbrella or excess liability obtained by Contractor required in this agreement where prohibited by law. This waiver must be stated on the certificate of insurance.
- J. Upon request, Contractor shall furnish Railroad with a certificate(s) of insurance, executed by a duly authorized representative of each insurer, showing compliance with the insurance requirements in this agreement.
- K. All insurance policies must be written by a reputable insurance company acceptable to Railroad or with a current Best's Insurance Guide Rating of A- and Class VII or better, and authorized to do business in the state where the work is being performed.
- L. The fact that insurance is obtained by Contractor or by Railroad on behalf of Contractor will not be deemed to release or diminish the liability of Contractor, including, without limitation, liability under the indemnity provisions of this agreement. Damages recoverable by Railroad from Contractor or any third party will not be limited by the amount of the required insurance coverage.

# **EXHIBIT B**

**TO**  
**GENERAL TERMS AND CONDITIONS**  
**OF THE**  
**CONTRACTOR'S ENDORSEMENT**

## **MINIMUM SAFETY REQUIREMENTS**

<https://www.up.com/suppliers/contractor-safety/index.htm>

**Certificate Of Completion**

Envelope Id: 55B47D1726934E018153526F35375B41	Status: Completed
Subject: 793829MCL 7850 854259H 2023-11-10 Agency Project: 0T1.129866	
Source Envelope:	
Document Pages: 4	Signatures: 1
Certificate Pages: 5	Initials: 0
AutoNav: Enabled	Envelope Originator:
Envelope Stamping: Enabled	Leo Craig
Time Zone: (UTC-06:00) Central Time (US & Canada)	1400 Douglas St MS910
	Omaha, NE 68179
	leo.craig@upcontractor.up.com
	IP Address: 70.122.242.56

**Record Tracking**

Status: Original	Holder: Leo Craig	Location: DocuSign
11/17/2023 4:14:46 PM	leo.craig@upcontractor.up.com	

**Signer Events**

Melinda DuBay  
 msdubay@up.com  
 Engineering-Industry & Public Projects-Manager I  
 Union Pacific Railroad  
 Security Level: Email, Account Authentication (None)

**Signature**

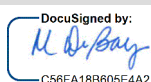
DocuSigned by:  
  
 C56FA18B605E4A2...  
 Signature Adoption: Uploaded Signature Image  
 Using IP Address: 69.58.206.114

**Timestamp**

Sent: 11/17/2023 4:16:37 PM  
 Viewed: 11/30/2023 3:31:54 PM  
 Signed: 11/30/2023 3:32:00 PM

**Electronic Record and Signature Disclosure:**  
 Accepted: 10/22/2019 2:45:20 PM  
 ID: b444c606-4c5b-4dd4-8676-6d8de04f75ac

**In Person Signer Events**

**Signature**

**Timestamp**

**Editor Delivery Events**

**Status**

**Timestamp**

**Agent Delivery Events**

**Status**

**Timestamp**

**Intermediary Delivery Events**

**Status**

**Timestamp**

**Certified Delivery Events**

**Status**

**Timestamp**

Linda Loomis  
 admin@lowermnrivewd.org  
 Security Level: Email, Account Authentication (None)

**VIEWED**  
 Using IP Address: 73.185.137.61

Sent: 11/30/2023 3:32:02 PM  
 Viewed: 11/30/2023 4:10:33 PM

**Electronic Record and Signature Disclosure:**  
 Accepted: 11/30/2023 4:10:33 PM  
 ID: d3710647-c523-45a3-9940-5c2010223984

**Carbon Copy Events**

**Status**

**Timestamp**

Doug Woods  
 dwoods@olsson.com  
 Security Level: Email, Account Authentication (None)

**COPIED**

Sent: 11/30/2023 3:32:02 PM

**Electronic Record and Signature Disclosure:**  
 Not Offered via DocuSign

Leo Craig  
 lcraig@olsson.com  
 Security Level: Email, Account Authentication (None)

**COPIED**

Sent: 11/30/2023 3:32:03 PM

Carbon Copy Events	Status	Timestamp
--------------------	--------	-----------

**Electronic Record and Signature Disclosure:**  
Accepted: 7/14/2023 10:16:16 AM  
ID: 4abfd857-4e2e-4692-9205-70e7053209b2

Peyton Lee  
plee2@olsson.com

**COPIED**

Sent: 11/30/2023 3:32:03 PM

Security Level: Email, Account Authentication  
(None)

**Electronic Record and Signature Disclosure:**  
Accepted: 5/4/2023 8:06:01 AM  
ID: 91fc6912-59e0-4f99-9f0c-00757c5bad5f

Linda Loomis  
admin@lowermnrivewrd.org

**COPIED**

Sent: 11/30/2023 4:10:34 PM

Security Level: Email, Account Authentication  
(None)

**Electronic Record and Signature Disclosure:**  
Accepted: 11/30/2023 4:10:33 PM  
ID: d3710647-c523-45a3-9940-5c2010223984

Brad Fisher  
bradley.fisher@bolton-menk.com

**COPIED**

Sent: 11/30/2023 4:10:34 PM

Security Level: Email, Account Authentication  
(None)

**Electronic Record and Signature Disclosure:**  
Not Offered via DocuSign

Witness Events	Signature	Timestamp
----------------	-----------	-----------

Notary Events	Signature	Timestamp
---------------	-----------	-----------

Envelope Summary Events	Status	Timestamps
-------------------------	--------	------------

Envelope Sent	Hashed/Encrypted	11/17/2023 4:16:37 PM
Envelope Updated	Security Checked	11/17/2023 4:17:47 PM
Certified Delivered	Security Checked	11/30/2023 4:10:33 PM
Signing Complete	Security Checked	11/30/2023 3:32:00 PM
Completed	Security Checked	11/30/2023 4:10:34 PM

Payment Events	Status	Timestamps
----------------	--------	------------

Electronic Record and Signature Disclosure
--

## **ELECTRONIC RECORD AND SIGNATURE DISCLOSURE**

From time to time, Union Pacific Corporation (we, us or Company) may be required by law to provide to you certain written notices or disclosures. Described below are the terms and conditions for providing to you such notices and disclosures electronically through the DocuSign system. Please read the information below carefully and thoroughly, and if you can access this information electronically to your satisfaction and agree to this Electronic Record and Signature Disclosure (ERSD), please confirm your agreement by selecting the check-box next to 'I agree to use electronic records and signatures' before clicking 'CONTINUE' within the DocuSign system.

### **Getting paper copies**

At any time, you may request from us a paper copy of any record provided or made available electronically to you by us. You will have the ability to download and print documents we send to you through the DocuSign system during and immediately after the signing session and, if you elect to create a DocuSign account, you may access the documents for a limited period of time (usually 30 days) after such documents are first sent to you. After such time, if you wish for us to send you paper copies of any such documents from our office to you, you will be charged a \$0.00 per-page fee. You may request delivery of such paper copies from us by following the procedure described below.

### **Withdrawing your consent**

If you decide to receive notices and disclosures from us electronically, you may at any time change your mind and tell us that thereafter you want to receive required notices and disclosures only in paper format. How you must inform us of your decision to receive future notices and disclosure in paper format and withdraw your consent to receive notices and disclosures electronically is described below.

### **Consequences of changing your mind**

If you elect to receive required notices and disclosures only in paper format, it will slow the speed at which we can complete certain steps in transactions with you and delivering services to you because we will need first to send the required notices or disclosures to you in paper format, and then wait until we receive back from you your acknowledgment of your receipt of such paper notices or disclosures. Further, you will no longer be able to use the DocuSign system to receive required notices and consents electronically from us or to sign electronically documents from us.

### **All notices and disclosures will be sent to you electronically**

Unless you tell us otherwise in accordance with the procedures described herein, we will provide electronically to you through the DocuSign system all required notices, disclosures, authorizations, acknowledgements, and other documents that are required to be provided or made available to you during the course of our relationship with you. To reduce the chance of you inadvertently not receiving any notice or disclosure, we prefer to provide all of the required notices and disclosures to you by the same method and to the same address that you have given us. Thus, you can receive all the disclosures and notices electronically or in paper format through the paper mail delivery system. If you do not agree with this process, please let us know as described below. Please also see the paragraph immediately above that describes the consequences of your electing not to receive delivery of the notices and disclosures electronically from us.

### **How to contact Union Pacific Corporation:**

You may contact us to let us know of your changes as to how we may contact you electronically, to request paper copies of certain information from us, and to withdraw your prior consent to receive notices and disclosures electronically as follows:

To contact us by phone call: (402) 544-3331

To contact us by email send messages to: [acampbe@upcontractor.up.com](mailto:acampbe@upcontractor.up.com)

### **To advise Union Pacific Corporation of your new email address**

To let us know of a change in your email address where we should send notices and disclosures electronically to you, you must send an email message to us at [acampbe@upcontractor.up.com](mailto:acampbe@upcontractor.up.com) and in the body of such request you must state: your previous email address, your new email address. We do not require any other information from you to change your email address.

If you created a DocuSign account, you may update it with your new email address through your account preferences.

### **To request paper copies from Union Pacific Corporation**

To request delivery from us of paper copies of the notices and disclosures previously provided by us to you electronically, you must send us an email to [acampbe@upcontractor.up.com](mailto:acampbe@upcontractor.up.com) and in the body of such request you must state your email address, full name, mailing address, and telephone number. We will bill you for any fees at that time, if any.

### **To withdraw your consent with Union Pacific Corporation**

To inform us that you no longer wish to receive future notices and disclosures in electronic format you may:



- i. decline to sign a document from within your signing session, and on the subsequent page, select the check-box indicating you wish to withdraw your consent, or you may;
- ii. send us an email to [acampbe@upcontractor.up.com](mailto:acampbe@upcontractor.up.com) and in the body of such request you must state your email, full name, mailing address, and telephone number. We do not need any other information from you to withdraw consent.. The consequences of your withdrawing consent for online documents will be that transactions may take a longer time to process..

### **Required hardware and software**

The minimum system requirements for using the DocuSign system may change over time. The current system requirements are found here: <https://support.docusign.com/guides/signer-guide-signing-system-requirements>.

### **Acknowledging your access and consent to receive and sign documents electronically**

To confirm to us that you can access this information electronically, which will be similar to other electronic notices and disclosures that we will provide to you, please confirm that you have read this ERSD, and (i) that you are able to print on paper or electronically save this ERSD for your future reference and access; or (ii) that you are able to email this ERSD to an email address where you will be able to print on paper or save it for your future reference and access. Further, if you consent to receiving notices and disclosures exclusively in electronic format as described herein, then select the check-box next to ‘I agree to use electronic records and signatures’ before clicking ‘CONTINUE’ within the DocuSign system.

By selecting the check-box next to ‘I agree to use electronic records and signatures’, you confirm that:

- You can access and read this Electronic Record and Signature Disclosure; and
- You can print on paper this Electronic Record and Signature Disclosure, or save or send this Electronic Record and Disclosure to a location where you can print it, for future reference and access; and
- Until or unless you notify Union Pacific Corporation as described above, you consent to receive exclusively through electronic means all notices, disclosures, authorizations, acknowledgements, and other documents that are required to be provided or made available to you by Union Pacific Corporation during the course of your relationship with Union Pacific Corporation.



# LOWER MINNESOTA RIVER WATERSHED DISTRICT

## CONSTRUCTION PLANS FOR

# VERNON AVENUE IMPROVEMENTS

BITUMINOUS STREET IMPROVEMENTS, AGGREGATE BASE & BITUMINOUS PAVING, CULVERT CROSSING

FEBRUARY, 2024

**RESOURCE LIST**

LOWER MINNESOTA RIVER WATERSHED DISTRICT  
HANNAH LECLAIRE  
763-568-0726  
Hannah@youngceg.com

CHARTER  
CHUCK SNYDER  
952-367-4246  
Charles.Snyder@charter.com

CITY OF SAVAGE  
6000 McCOLL DR  
SAVAGE MN 55378

LUMEN (CENTURYLINK)  
RANDALL OLSON  
Randall.Olson@lumen.com

CITY ENGINEER/UTILITIES DIRECTOR  
SENG THONGVANH  
952-882-2671

COGENT (SPRINT/T-MOBILE)  
MIKE CHEBUL  
mchebul@cogentco.com

**UTILITIES:**

**COMMUNICATIONS**  
ARVIG  
RICKY ASP  
Ricky.Asp@arvig.com

**ELECTRIC**  
XCEL ENERGY  
COLBY CARLISLE  
Colby.D.Carlisle@xcelenergy.com

**AT&T TRANSMISSION**  
JANDY SANTOYA  
786-277-6357  
JS0613@att.com

**GAS**  
CENTERPOINT ENERGY  
IBRAHIM SAREVA  
Ibrahim.Sareva@CenterPointEnergy.com

NOTE: EXISTING UTILITY INFORMATION SHOWN ON THIS PLAN HAS BEEN PROVIDED BY THE UTILITY OWNER. THE CONTRACTOR SHALL FIELD VERIFY EXACT LOCATIONS PRIOR TO COMMENCING CONSTRUCTION AS REQUIRED BY STATE LAW. NOTIFY GOPHER STATE ONE CALL, 1-800-252-1166 OR 651-454-0002.

THE SUBSURFACE UTILITY INFORMATION IN THIS PLAN IS UTILITY QUALITY LEVEL D UNLESS OTHERWISE NOTED. THIS UTILITY LEVEL WAS DETERMINED ACCORDING TO THE GUIDELINES OF CI/ASCE 38-02, ENTITLED "STANDARD GUIDELINES FOR THE COLLECTION AND DEPICTION OF EXISTING SUBSURFACE UTILITY DATA."

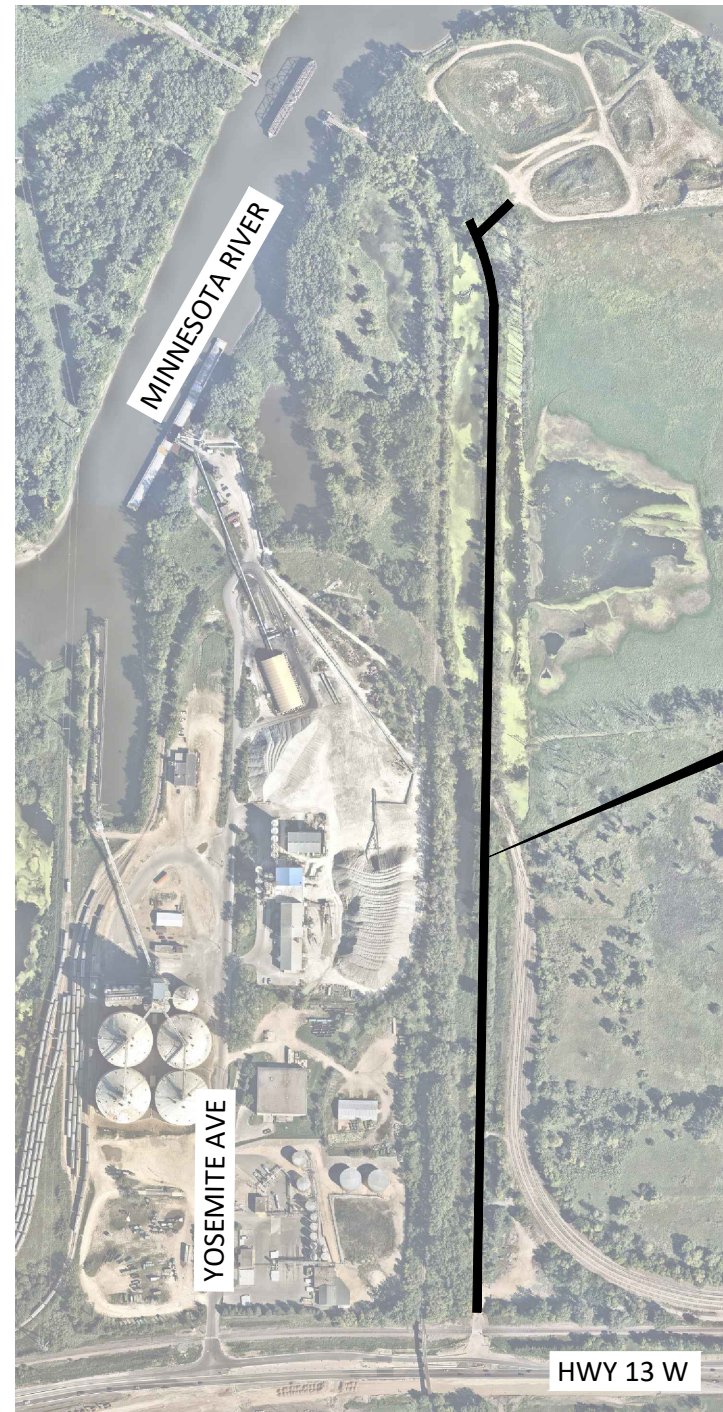

MAP OF THE CITY OF SAVAGE  
DAKOTA COUNTY, MN

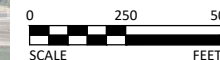

PROJECT LOCATION

SHEET NUMBER	SHEET TITLE
<b>GENERAL</b>	
G0.01 - G0.02	TITLE SHEET, LEGEND
G1.01	STATEMENT OF ESTIMATED QUANTITIES
<b>CIVIL</b>	
C0.01 - C0.03	EXISTING CONDITIONS, REMOVALS PLAN
C1.01 - C1.04	TABLES, DETAILS & TYPICAL SECTIONS
C2.01 - C2.06	EROSION CONTROL PLAN, SWPPP
C5.01	STORM SEWER PLAN & PROFILE
C6.01 - C6.06	STREET PLAN & PROFILE
C8.01 - C8.13	CROSS SECTIONS
THIS PLAN SET CONTAINS <u>36</u> SHEETS.	

**MAP LEGEND**

PROJECT LIMITS

⚬ BM=722.01 MnDOT Geodetic Mon. No 1901 H 1	PROJECT DATUM: SCOTT COUNTY COORDINATE SYSTEM	RECORD DRAWING INFORMATION
	HORIZONTAL: NAD 83 (96 ADJ)	OBSERVER:
	VERTICAL: NAVD 88	CONTRACTOR:
		DATE:

© Bolton & Menk, Inc. 2023. All Rights Reserved. 12224 NICOLLET AVENUE, BURNSVILLE, MN 55337. 1/25/2024 4:14:37 PM

I HEREBY CERTIFY THAT THIS PLAN, SPECIFICATION, OR REPORT WAS PREPARED BY ME OR UNDER MY DIRECT SUPERVISION AND THAT I AM A DULY LICENSED PROFESSIONAL ENGINEER UNDER THE LAWS OF THE STATE OF MINNESOTA.

*Bradley J Fisher*  
BRADLEY J FISHER  
LIC. NO. 56595 DATE 02/21/2024



12224 NICOLLET AVENUE  
BURNSVILLE, MINNESOTA 55337  
Phone: (952) 890-0509  
Email: Burnsville@bolton-menk.com  
www.bolton-menk.com

DESIGNED	NO.	ISSUED FOR	DATE
JLW			
DRAWN			
JLW			
CHECKED			
BJF			
CLIENT PROJ. NO.			
0T1.129866			

LOWER MINNESOTA RIVER WATERSHED DISTRICT  
VERNON AVENUE IMPROVEMENTS  
TITLE SHEET

SHEET  
G0.01

### EXISTING TOPOGRAPHIC SYMBOLS

	ACCESS GRATE		REGULATION STATION GAS
	AIR CONDITION UNIT		SATELLITE DISH
	ANTENNA		SIGN NON TRAFFIC
	AUTO SPRINKLER CONNECTION		SIGN TRAFFIC
	BARRICADE PERMANENT		SIGNAL CONTROL CABINET
	BASKETBALL POST		SOIL BORING
	BENCH		SIREN
	BIRD FEEDER		TELEPHONE BOOTH
	BOLLARD		TILE INLET
	BUSH		TILE OUTLET
	CATCH BASIN RECTANGULAR CASTING		TILE RISER
	CATCH BASIN CIRCULAR CASTING		TRANSFORMER-ELECTRIC
	CURB STOP		TREE-CONIFEROUS
	CLEAN OUT		TREE-DEAD
	CULVERT END		TREE-DECIDUOUS
	DRINKING FOUNTAIN		TREE STUMP
	DOWN SPOUT		TRAFFIC ARM BARRIER
	FILL PIPE		TRAFFIC SIGNAL
	FIRE HYDRANT		TRASH CAN
	FLAG POLE		UTILITY MARKER
	FLARED END / APRON		VALVE
	FUEL PUMP		VALVE POST INDICATOR
	GRILL		VALVE VAULT
	GUY WIRE ANCHOR		VAULT
	HANDHOLE		VENT PIPE
	HANDICAP SPACE		WATER SPIGOT
	IRRIGATION SPRINKLER HEAD		WELL
	IRRIGATION VALVE BOX		WETLAND DELINEATED MARKER
	LIFT STATION CONTROL PANEL		WETLAND
	LIFT STATION		WET WELL
	LIGHT ON POLE		YARD HYDRANT
	LIGHT-GROUND		
	MAILBOX		
	MANHOLE-COMMUNICATION		
	MANHOLE-ELECTRIC		
	MANHOLE-GAS		
	MANHOLE-HEAT		
	MANHOLE-SANITARY SEWER		
	MANHOLE-STORM SEWER		
	MANHOLE-UTILITY		
	MANHOLE-WATER		
	METER		
	ORDER MICROPHONE		
	PARKING METER		
	PAVEMENT MARKING		
	PEDESTAL-COMMUNICATION		
	PEDESTAL-ELECTRIC		
	PEDESTRIAN PUSH BUTTON		
	PICNIC TABLE		
	POLE-UTILITY		
	POLE-BRACE		
	POST		
	RAILROAD SIGNAL POLE		

### PROPOSED TOPOGRAPHIC SYMBOLS

	CLEANOUT
	MANHOLE
	LIFT STATION
	STORM SEWER CIRCULAR CASTING
	STORM SEWER RECTANGULAR CASTING
	STORM SEWER FLARED END / APRON
	STORM SEWER OUTLET STRUCTURE
	STORM SEWER OVERFLOW STRUCTURE
	CURB BOX
	FIRE HYDRANT
	WATER VALVE
	WATER REDUCER
	WATER BEND
	WATER TEE
	WATER CROSS
	WATER SLEEVE
	WATER CAP / PLUG
	RIP RAP
	DRAINAGE FLOW
	TRAFFIC SIGNS

### SURVEY SYMBOLS

	BENCHMARK LOCATION		CAST IRON MONUMENT
	CONTROL POINT		STONE MONUMENT
	MONUMENT FOUND		

### EXISTING TOPOGRAPHIC LINES

	RETAINING WALL
	FENCE
	FENCE-DECORATIVE
	GUARD RAIL
	TREE LINE
	BUSH LINE

### SURVEY LINES

	CONTROLLED ACCESS
	BOUNDARY
	CENTERLINE
	EXISTING EASEMENT LINE
	PROPOSED EASEMENT LINE
	EXISTING LOT LINE
	PROPOSED LOT LINE
	EXISTING RIGHT-OF-WAY
	PROPOSED RIGHT-OF-WAY
	SETBACK LINE
	SECTION LINE
	QUARTER LINE
	SIXTEENTH LINE
	TEMPORARY EASEMENT

### EXISTING UTILITY LINES

	FORCEMAIN
	SANITARY SEWER
	SANITARY SERVICE
	STORM SEWER
	STORM SEWER DRAIN TILE
	WATERMAIN
	WATER SERVICE

### PROPOSED UTILITY LINES

	FORCEMAIN
	SANITARY SEWER
	SANITARY SERVICE
	STORM SEWER
	STORM SEWER DRAIN TILE
	WATERMAIN
	WATER SERVICE
	PIPE CASING
	TRENCHLESS PIPE (PLAN VIEW)
	TRENCHLESS PIPE (PROFILE VIEW)

### GRADING INFORMATION

	EXISTING CONTOUR MINOR
	EXISTING CONTOUR MAJOR
	PROPOSED CONTOUR MINOR
	PROPOSED CONTOUR MAJOR
	PROPOSED GRADING LIMITS / SLOPE LIMITS
	PROJECT LIMITS
	PROPOSED SPOT ELEVATION
	RISE:RUN (SLOPE)

### HATCH PATTERNS

	BITUMINOUS		GRAVEL
	CONCRETE		

### EXISTING PRIVATE UTILITY LINES

NOTE:  
EXISTING UTILITY INFORMATION SHOWN ON THIS PLAN HAS BEEN PROVIDED BY THE UTILITY OWNER. THE CONTRACTOR SHALL FIELD VERIFY EXACT LOCATIONS PRIOR TO COMMENCING CONSTRUCTION AS REQUIRED BY STATE LAW. NOTIFY GOPHER STATE ONE CALL, 1-800-252-1166 OR 651-454-0002.

THE SUBSURFACE UTILITY INFORMATION IN THIS PLAN IS UTILITY QUALITY LEVEL D UNLESS OTHERWISE NOTED. THIS UTILITY LEVEL WAS DETERMINED ACCORDING TO THE GUIDELINES OF CI/ASCE 38-02, ENTITLED "STANDARD GUIDELINES FOR THE COLLECTION AND DEPICTION OF EXISTING SUBSURFACE UTILITY DATA"

	UNDERGROUND FIBER OPTIC
	UNDERGROUND ELECTRIC
	UNDERGROUND GAS
	UNDERGROUND COMMUNICATION
	OVERHEAD ELECTRIC
	OVERHEAD COMMUNICATION
	OVERHEAD UTILITY

UTILITIES IDENTIFIED WITH A QUALITY LEVEL :

LINE TYPES FOLLOW THE FORMAT: UTILITY TYPE - QUALITY LEVEL  
EXAMPLE: UNDERGROUND GAS, QUALITY LEVEL A  
UTILITY QUALITY LEVEL (A,B,C,D) DEFINITIONS CAN BE FOUND IN CI/ASCE 38-02.

UTILITY QUALITY LEVELS:

QUALITY LEVEL D: PROVIDES THE MOST BASIC LEVEL OF INFORMATION. IT INVOLVES COLLECTING DATA FROM EXISTING UTILITY RECORDS. RECORDS MAY INCLUDE AS-BUILT DRAWINGS, DISTRIBUTION AND SERVICES MAPS, EXISTING GEOGRAPHIC INFORMATION SYSTEM DATABASES, CONSTRUCTION PLANS, ETC.

QUALITY LEVEL C: INVOLVES SURVEYING VISIBLE SUBSURFACE UTILITY STRUCTURES SUCH AS MANHOLES, HAND-HOLES, UTILITY VALVES AND METERS, FIRE HYDRANTS, PEDESTALS AND UTILITY MARKERS, AND THEN CORRELATING THE INFORMATION WITH EXISTING UTILITY RECORDS TO CREATE COMPOSITE DRAWINGS. INCLUDES QUALITY LEVEL D ACTIVITIES.

QUALITY LEVEL B: INVOLVES DESIGNATING THE HORIZONTAL POSITION OF SUBSURFACE UTILITIES THROUGH SURFACE DETECTION METHODS AND COLLECTING THE INFORMATION THROUGH A SURVEY METHOD. INCLUDES QUALITY LEVEL C AND D TASKS.

QUALITY LEVEL A: PROVIDES THE HIGHEST LEVEL OF ACCURACY. IT INVOLVES LOCATING OR POTHOLING UTILITIES AS WELL AS ACTIVITIES IN QUALITY LEVELS B, C, AND D. THE LOCATED FACILITY INFORMATION IS SURVEYED AND MAPPED AND THE DATA PROVIDES PRECISE PLAN AND PROFILE INFORMATION.

### ABBREVIATIONS

A	ALGEBRAIC DIFFERENCE	GRAV	GRAVEL	RSC	RIGID STEEL CONDUIT
ADJ	ADJUST	GU	GUTTER	RT	RIGHT
ALT	ALTERNATE	GV	GATE VALVE	SAN	SANITARY SEWER
B-B	BACK TO BACK	HDPE	HIGH DENSITY POLYETHYLENE	SCH	SCHEDULE
BIT	BITUMINOUS	HH	HANDHOLE	SERV	SERVICE
BLDG	BUILDING	HP	HIGH POINT	SHLD	SHOULDER
BMP	BEST MANAGEMENT PRACTICE	HWL	HIGH WATER LEVEL	STA	STATION
BR	BEGIN RADIUS	HYD	HYDRANT	STD	STANDARD
BV	BUTTERFLY VALVE	I	INVERT	STM	STORM SEWER
CB	CATCH BASIN	K	CURVE COEFFICIENT	TC	TOP OF CURB
C&G	CURB AND GUTTER	L	LENGTH	TE	TEMPORARY EASEMENT
CIP	CAST IRON PIPE	LO	LOWEST OPENING	TEMP	TEMPORARY
CIPP	CURED-IN-PLACE PIPE	LP	LOW POINT	TNH	TOP NUT HYDRANT
CL	CENTER LINE	LT	LEFT	TP	TOP OF PIPE
CL	CLASS	MAX	MAXIMUM	TYP	TYPICAL
CLVT	CULVERT	MH	MANHOLE	VCP	VITRIFIED CLAY PIPE
CMP	CORRUGATED METAL PIPE	MIN	MINIMUM	VERT	VERTICAL
C.O.	CHANGE ORDER	MR	MID RADIUS	VPC	VERTICAL POINT OF CURVE
COMM	COMMUNICATION	NIC	NOT IN CONTRACT	VPI	VERTICAL POINT OF INTERSECTION
CON	CONCRETE	NMC	NON-METALLIC CONDUIT	VPT	VERTICAL POINT OF TANGENT
CSP	CORRUGATED STEEL PIPE	NTS	NOT TO SCALE	WM	WATERMAIN
DIA	DIAMETER	NWL	NORMAL WATER LEVEL	AC	ACRES
DIP	DUCTILE IRON PIPE	OHW	ORDINARY HIGH WATER LEVEL	CF	CUBIC FEET
DWY	DRIVEWAY	PC	POINT OF CURVE	CV	COMPACTED VOLUME
E	EXTERNAL CURVE DISTANCE	PCC	POINT OF COMPOUND CURVE	CY	CUBIC YARD
ELEC	ELECTRIC	PE	PERMANENT EASEMENT	EA	EACH
ELEV	ELEVATION	PED	PEDESTRIAN, PEDESTAL	EV	EXCAVATED VOLUME
EOF	EMERGENCY OVERFLOW	PERF	PERFORATED PIPE	LB	POUND
ER	END RADIUS	PERM	PERMANENT	LF	LINEAR FEET
ESMT	EASEMENT	PI	POINT OF INTERSECTION	LS	LUMP SUM
EX	EXISTING	PL	PROPERTY LINE	LV	LOOSE VOLUME
FES	FLARED END SECTION	PRC	POINT OF REVERSE CURVE	SF	SQUARE FEET
F-F	FACE TO FACE	PT	POINT OF TANGENT	SV	STOCKPILE VOLUME
FF	FINISHED FLOOR	PVC	POLYVINYL CHLORIDE PIPE	SY	SQUARE YARD
F&I	FURNISH AND INSTALL	PVMT	PAVEMENT		
FM	FORCEMAIN	R	RADIUS		
FO	FIBER OPTIC	R/W	RIGHT-OF-WAY		
F.O.	FIELD ORDER	RCP	REINFORCED CONCRETE PIPE		
GRAN	GRANULAR	RET	RETAINING		

© Bolton & Menk, Inc. 2024. All Rights Reserved. PROJECT: 1725/2024-4-14-02 PM. DRAWING: 123456789

I HEREBY CERTIFY THAT THIS PLAN, SPECIFICATION, OR REPORT WAS PREPARED BY ME OR UNDER MY DIRECT SUPERVISION AND THAT I AM A DULY LICENSED PROFESSIONAL ENGINEER UNDER THE LAWS OF THE STATE OF MINNESOTA.  
Bradley J Fisher  
BRADLEY J FISHER  
LIC. NO. 56595 DATE 02/21/2024



12224 NICOLLET AVENUE  
BURNSVILLE, MINNESOTA 55337  
Phone: (952) 890-0509  
Email: Burnsவில்le@bolton-menk.com  
www.bolton-menk.com

DESIGNED	JLW	NO.		ISSUED FOR		DATE	
DRAWN	JLW						
CHECKED	BJF						
CLIENT PROJ. NO.	0T1.129866						

LOWER MINNESOTA RIVER WATERSHED DISTRICT

VERNON AVENUE IMPROVEMENTS

LEGEND

SHEET

G0.02

## STATEMENT OF ESTIMATED QUANTITIES

ITEM NO.	SPEC. REF	DESCRIPTION	NOTES	UNIT	TOTAL ESTIMATED QUANTITY
1	2021.501	MOBILIZATION		LUMP SUM	1.0
2	2101.502	CLEARING		EACH	48.0
3	2101.502	GRUBBING		EACH	48.0
4	2104.502	SALVAGE SIGN		EACH	1.0
5	2104.503	SAWING BITUMINOUS PAVEMENT (FULL DEPTH)		LIN FT	26.0
6	2104.503	REMOVE SEWER PIPE (STORM)	(1)	LIN FT	96.0
7	2104.504	REMOVE BITUMINOUS PAVEMENT	(P) (2)	SQ YD	9320.0
8	2104.507	REMOVE RIPRAP	(EV)	CU YD	40.0
9	2106.507	EXCAVATION - COMMON	(EV) (P)	CU YD	6358.0
10	2106.507	EXCAVATION - SUBGRADE	(EV) (3)	CU YD	262.0
11	2106.507	SELECT GRANULAR EMBANKMENT	(CV) (P)	CU YD	3366.0
12	2106.507	STABILIZING AGGREGATE	(CV) (3)	CU YD	262.0
13	2106.601	DEWATERING	(4)	LUMP SUM	1.0
14	2106.603	MINOR GRADING	(5)	LIN FT	80.0
15	2118.507	AGGREGATE SURFACING CLASS 2	(CV) (P)	CU YD	188.0
16	2123.510	COMMON LABORERS	(3)	HOURL	15.0
17	2123.510	DOZER	(3)	HOURL	5.0
18	2123.610	CRAWLER MOUNTED BACKHOE	(3)	HOURL	5.0
19	2211.507	AGGREGATE BASE CLASS 5	(CV) (P)	CU YD	2244.0
20	2357.506	BITUMINOUS MATERIAL FOR TACK COAT		GAL	550.0
21	2360.509	TYPE SP 9.5 WEARING COURSE MIXTURE (3,C)		TON	1848.0
22	2501.502	48" RC PIPE APRON	(6) (7)	EACH	2.0
23	2503.503	48" RC PIPE SEWER CLASS III	(7)	LIN FT	84.0
24	2511.507	RANDOM RIPRAP CLASS III	(8)	CU YD	80.0
25	2563.601	TRAFFIC CONTROL		LUMP SUM	1.0
26	2563.621	TRAFFIC CONTROL SPECIAL (RR FLAGGING)		DOL	15000.0
27	2564.602	INSTALL SIGN	(9)	EACH	1.0
28	2572.602	TREE PRUNING	(3)	HOURL	12.0
29	2573.501	STABILIZED CONSTRUCTION EXIT		LUMP SUM	1.0
30	2573.502	STORM DRAIN INLET PROTECTION		EACH	3.0
31	2573.503	FLOTATION SILT CURTAIN TYPE STILL WATER		LIN FT	40.0
32	2573.503	SEDIMENT CONTROL LOG TYPE WOOD FIBER		LIN FT	14000.0
33	2574.507	COMMON TOPSOIL BORROW	(LV)	CU YD	1426.0
34	2575.504	ROLLED EROSION PREVENTION CATEGORY 20 W/ SEED MIX (25-141)	(10)	SQ YD	8295.0
35	2575.504	ROLLED EROSION PREVENTION CATEGORY 20 W/ SEED MIX (34-181)	(10)	SQ YD	257.0

**NOTES:**

- (1) INCLUDES REMOVAL OF PIPE APRONS AND ASSOCIATED APPURTENANCES.
  - (2) PAVEMENT DEPTHS ARE APPROXIMATE AND ARE REFERENCED IN THE GEOTECHNICAL REPORT. VARIANCE IN PAVEMENT THICKNESS WILL NOT BE COMPENSATED AND IS INCIDENTAL.
  - (3) TOKEN QUANTITY, TO BE USED AS DIRECTED BY THE ENGINEER.
  - (4) INCLUDES ALL WORK NECESSARY TO PROVIDE A STREAM/DITCH BYPASS AND DEWATERING, AS NECESSARY, TO ALLOW FOR CONSTRUCTION OF THE STORM CULVERT INSTALLATION.
  - (5) INCLUDES THE CLEARING OF ACCUMULATED DEBRIS AND RE-GRADING DITCHES TO PROVIDE PROPER DRAINAGE AS THEY APPROACH THE NEW CULVERT APRONS.
  - (6) INCLUDES FURNISHING & INSTALLATION OF TRASH GUARD, AS INDICATED IN THE DETAILS.
  - (7) INCLUDES FURNISHING & INSTALLATION OF PIPE TIES ON ALL PIPE JOINTS ALONG THE CULVERT AND INSTALLATION OF FINE AGGREGATE BEDDING, AS INDICATED IN THE DETAILS.
  - (8) INCLUDES THE FURNISHING AND INSTALLATION OF GEOTEXTILE FABRIC, AS SPECIFIED.
  - (9) NEW SIGN PANELS AND SALVAGED SIGNS TO BE REINSTALLED SHALL INCLUDE NEW SIGN POSTS, HARDWARE, AND INSTALLATION AS REQUIRED AND SHALL BE INCLUDED IN THE PRICE BID.
  - (10) INCLUDES THE FURNISHING AND INSTALLATION OF FERTILIZER AND SEED MIXTURE, AS SPECIFIED.
- (CV) COMPACTED VOLUME  
 (EV) EXCAVATED VOLUME  
 (LV) LOOSE VOLUME  
 (P) PLAN QUANTITY

© Bolton & Menk, Inc. 2024. All Rights Reserved. 11/25/2024 4:14:44 PM

I HEREBY CERTIFY THAT THIS PLAN, SPECIFICATION, OR REPORT WAS PREPARED BY ME OR UNDER MY DIRECT SUPERVISION AND THAT I AM A DULY LICENSED PROFESSIONAL ENGINEER UNDER THE LAWS OF THE STATE OF MINNESOTA.

*Bradley J Fisher*  
 BRADLEY J FISHER  
 LIC. NO. 56595 DATE 02/21/2024



12224 NICOLLET AVENUE  
 BURNSVILLE, MINNESOTA 55337  
 Phone: (952) 890-0509  
 Email: Burnsville@bolton-menk.com  
 www.bolton-menk.com

DESIGNED	NO.	ISSUED FOR	DATE
JLW			
JLW			
BJF			
CLIENT PROJ. NO.	011.129866		

LOWER MINNESOTA RIVER WATERSHED DISTRICT  
 VERNON AVENUE IMPROVEMENTS  
 STATEMENT OF ESTIMATED QUANTITIES

SHEET

G1.01

UNION PACIFIC RAILROAD

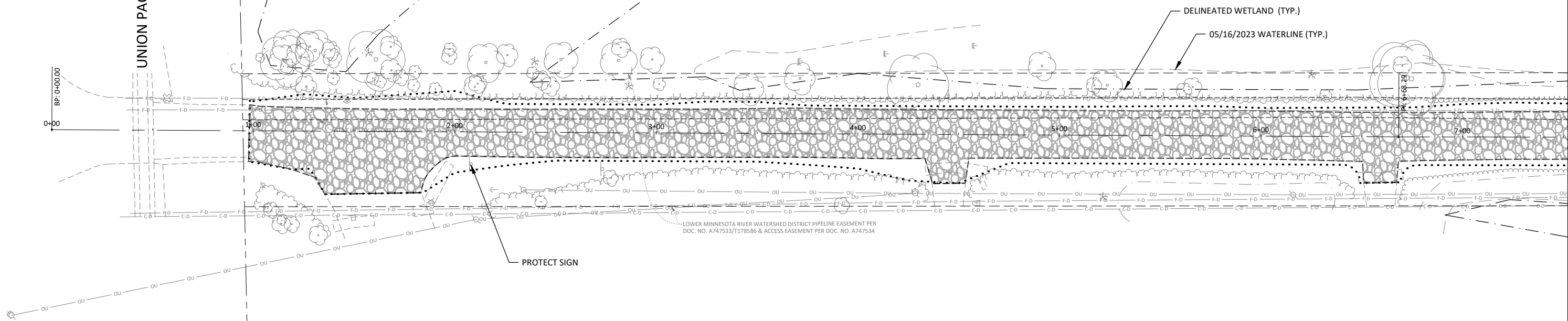

LOWER MINNESOTA RIVER WATERSHED DISTRICT PIPELINE EASEMENT PER DOC. NO. A747533/T178586 & ACCESS EASEMENT PER DOC. NO. A747534

**LEGEND**

- REMOVE BITUMINOUS PAVEMENT
- REMOVE EXISTING DETERIORATED BITUMINOUS PAVEMENT/ GRAVEL ROADWAY
- STORM SEWER PIPE REMOVAL
- CONSTRUCTION LIMITS
- TREE REMOVAL

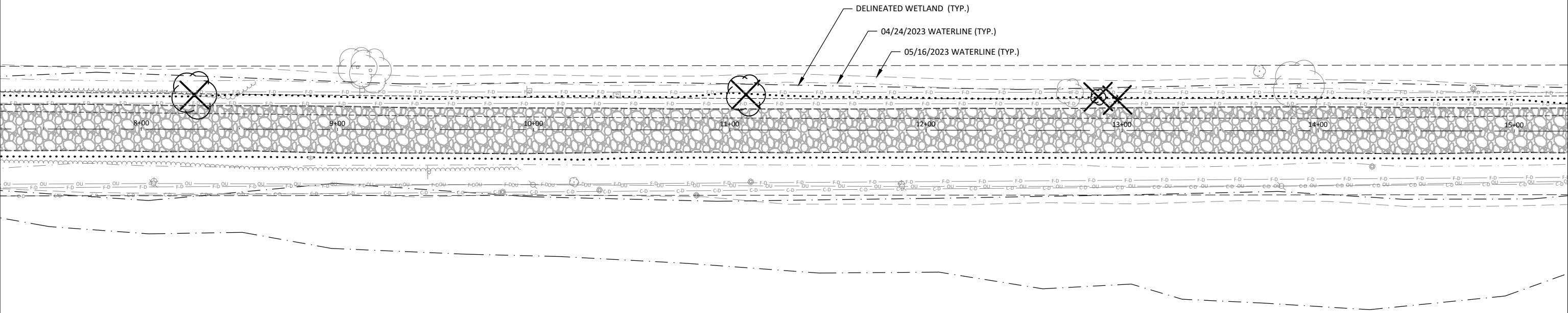

© Bolton & Menk, Inc. 2023. All Rights Reserved. P:\LOWMINN\RD\122986\CD\122986\CD01.dwg 1/25/2024 4:14:56 PM

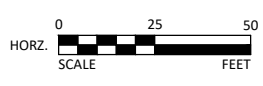

I HEREBY CERTIFY THAT THIS PLAN, SPECIFICATION, OR REPORT WAS PREPARED BY ME OR UNDER MY DIRECT SUPERVISION AND THAT I AM A DULY LICENSED PROFESSIONAL ENGINEER UNDER THE LAWS OF THE STATE OF MINNESOTA.

*Bradley J Fisher*  
 BRADLEY J FISHER  
 LIC. NO. 56595 DATE 02/21/2024



12224 NICOLLET AVENUE  
 BURNSVILLE, MINNESOTA 55337  
 Phone: (952) 890-0509  
 Email: Burnsville@bolton-menk.com  
 www.bolton-menk.com

DESIGNED	NO.	ISSUED FOR	DATE
JLW			
DRAWN			
JLW			
CHECKED			
BJF			
CLIENT PROJ. NO.			
0T1.129866			

LOWER MINNESOTA RIVER WATERSHED DISTRICT  
 VERNON AVENUE IMPROVEMENTS  
 EXISTING CONDITIONS & REMOVAL PLAN

SHEET  
 C0.01

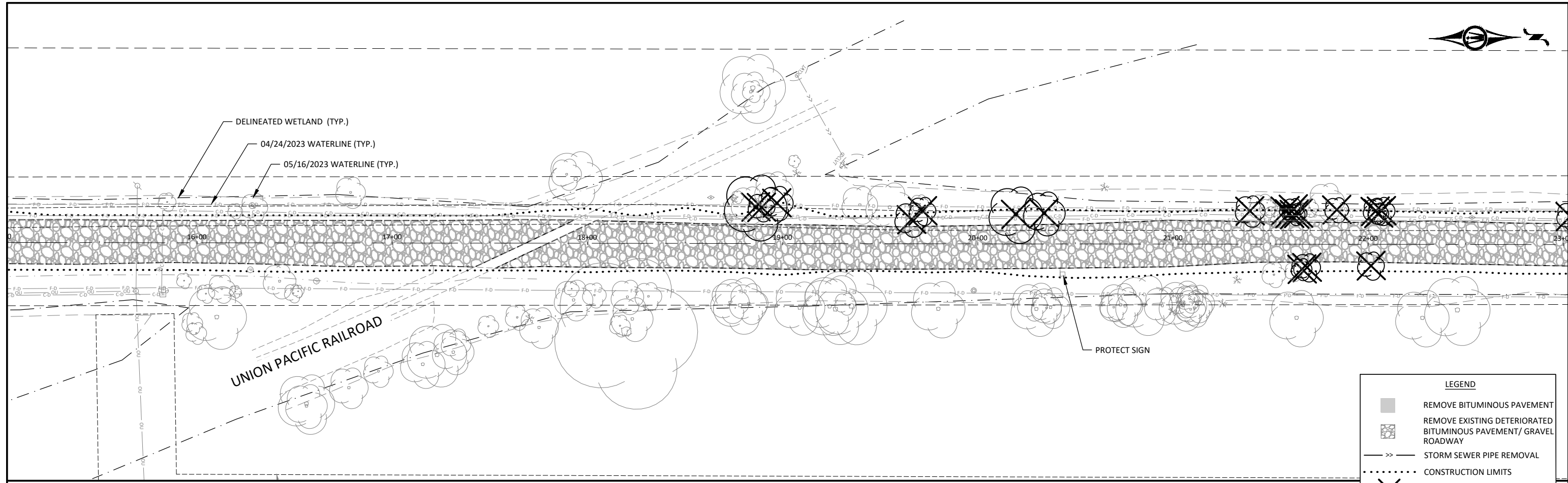

LEGEND	
	REMOVE BITUMINOUS PAVEMENT
	REMOVE EXISTING DETERIORATED BITUMINOUS PAVEMENT/ GRAVEL ROADWAY
	STORM SEWER PIPE REMOVAL
	CONSTRUCTION LIMITS
	TREE REMOVAL

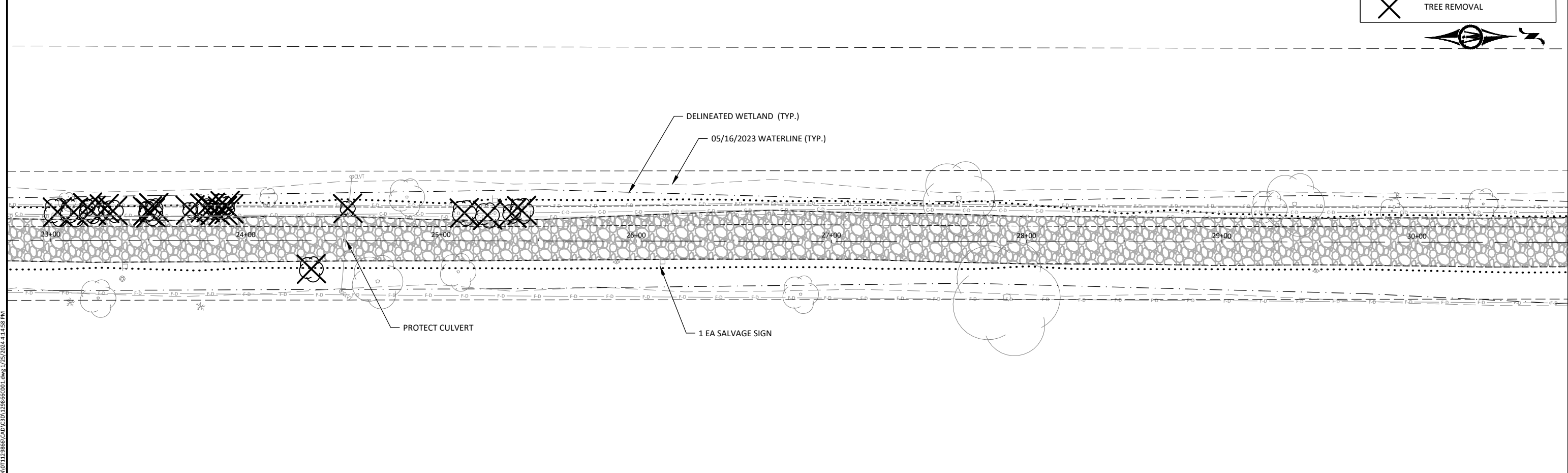

© Bolton & Menk, Inc. 2023. All Rights Reserved. PLANNING AND DESIGN DIVISION 129866.C01.dwg 1/25/2024 4:14:58 PM

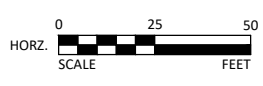

I HEREBY CERTIFY THAT THIS PLAN, SPECIFICATION, OR REPORT WAS PREPARED BY ME OR UNDER MY DIRECT SUPERVISION AND THAT I AM A DULY LICENSED PROFESSIONAL ENGINEER UNDER THE LAWS OF THE STATE OF MINNESOTA.

*Bradley J Fisher*  
 BRADLEY J FISHER  
 LIC. NO. 56595 DATE 02/21/2024



12224 NICOLLET AVENUE  
 BURNSVILLE, MINNESOTA 55337  
 Phone: (952) 890-0509  
 Email: Burnsville@bolton-menk.com  
 www.bolton-menk.com

DESIGNED	NO.	ISSUED FOR	DATE
JLW			
DRAWN			
JLW			
CHECKED			
BJF			
CLIENT PROJ. NO.			
0T1.129866			

LOWER MINNESOTA RIVER WATERSHED DISTRICT  
 VERNON AVENUE IMPROVEMENTS  
 EXISTING CONDITIONS & REMOVAL PLAN

SHEET  
 C0.02

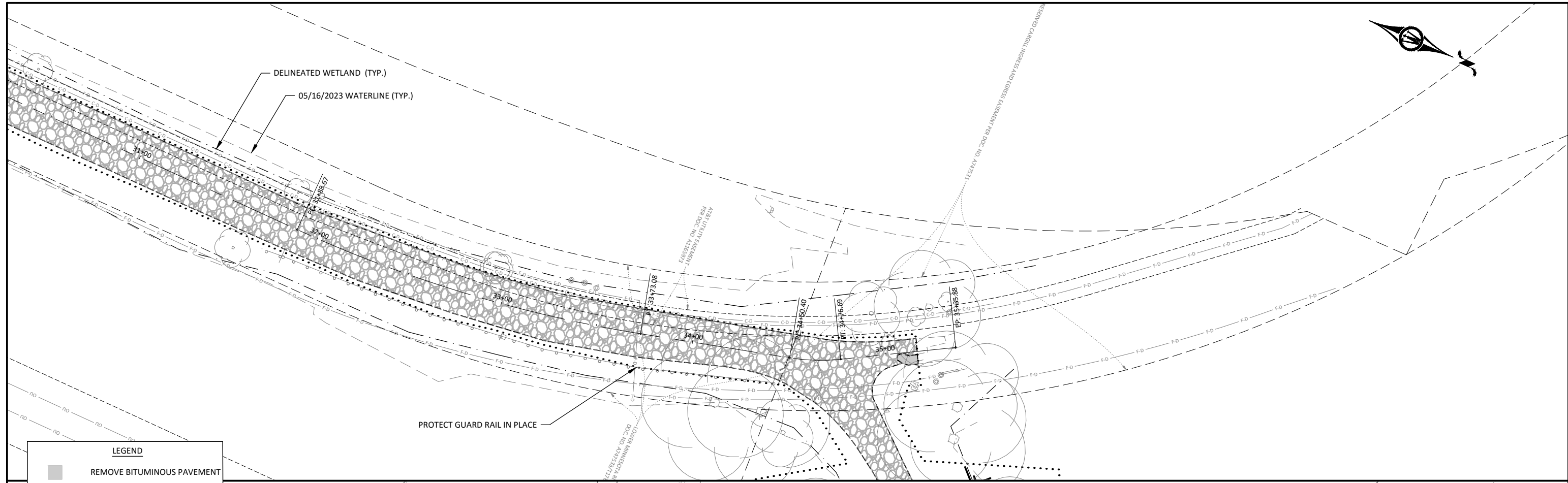

**LEGEND**

- REMOVE BITUMINOUS PAVEMENT
- REMOVE EXISTING DETERIORATED BITUMINOUS PAVEMENT/ GRAVEL ROADWAY
- STORM SEWER PIPE REMOVAL
- CONSTRUCTION LIMITS
- X TREE REMOVAL

LMRWD/US ARMY CORPS OF ENGINEERS DREDGE SITE

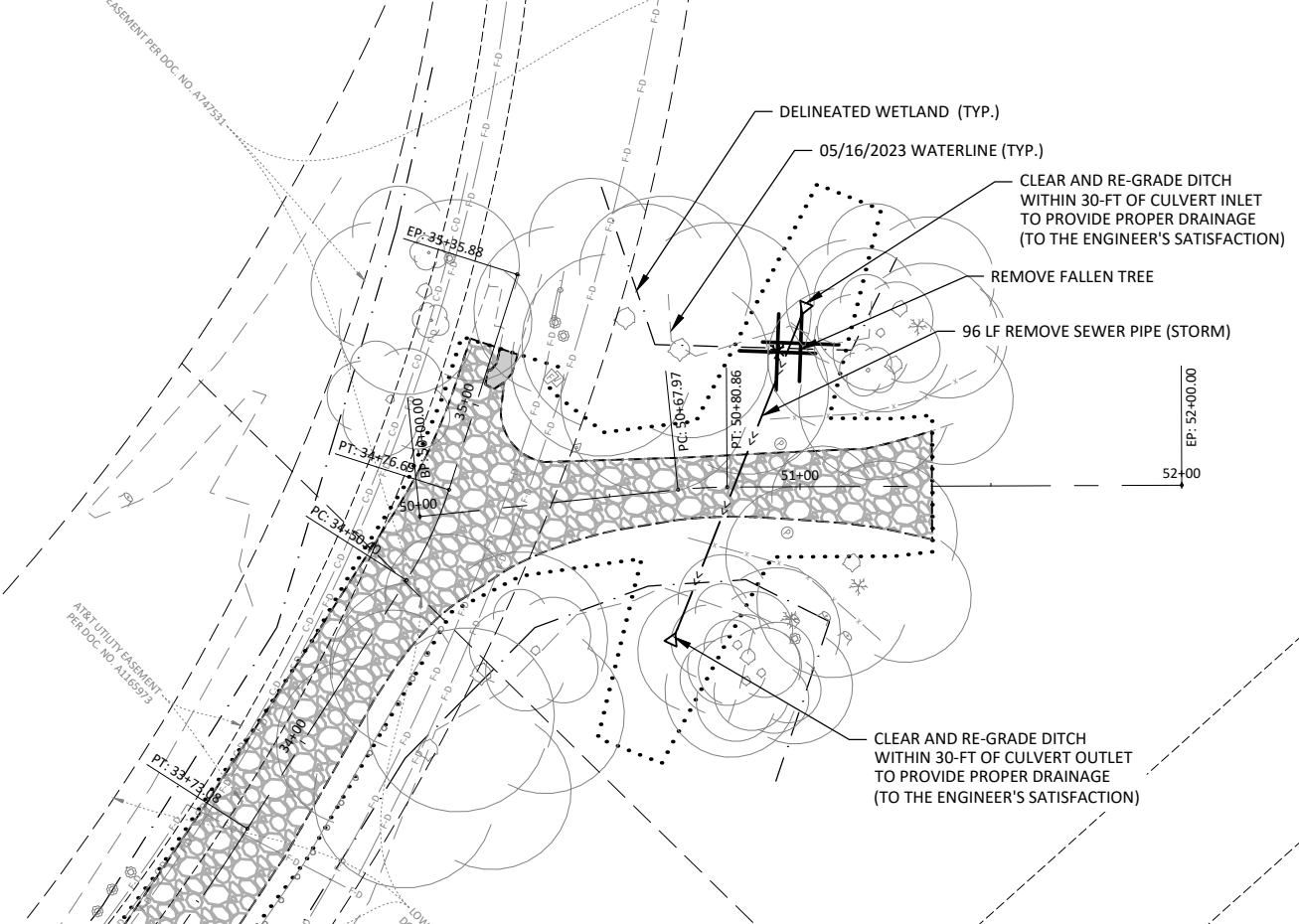
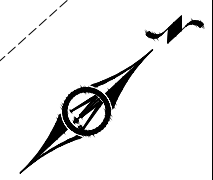

© Bolton & Menk, Inc. 2023. All Rights Reserved. PL\CD\MINNAPL\CD\129866\CD\129866.CDD 1/25/2024 4:15:00 PM

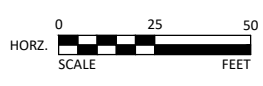

I HEREBY CERTIFY THAT THIS PLAN, SPECIFICATION, OR REPORT WAS PREPARED BY ME OR UNDER MY DIRECT SUPERVISION AND THAT I AM A DULY LICENSED PROFESSIONAL ENGINEER UNDER THE LAWS OF THE STATE OF MINNESOTA.

*Bradley J Fisher*  
 BRADLEY J FISHER  
 LIC. NO. 56595 DATE 02/21/2024



12224 NICOLLET AVENUE  
 BURNSVILLE, MINNESOTA 55337  
 Phone: (952) 890-0509  
 Email: Burnsville@bolton-menk.com  
 www.bolton-menk.com

DESIGNED	NO.	ISSUED FOR	DATE
JLW			
DRAWN	JLW		
CHECKED	BJF		
CLIENT PROJ. NO.	0T1.129866		

LOWER MINNESOTA RIVER WATERSHED DISTRICT  
 VERNON AVENUE IMPROVEMENTS  
 EXISTING CONDITIONS & REMOVAL PLAN

SHEET  
**C0.03**



**VERNON AVENUE  
TYPICAL SECTION**

0+97.80 - 17+50  
19+25 - 35+16.05

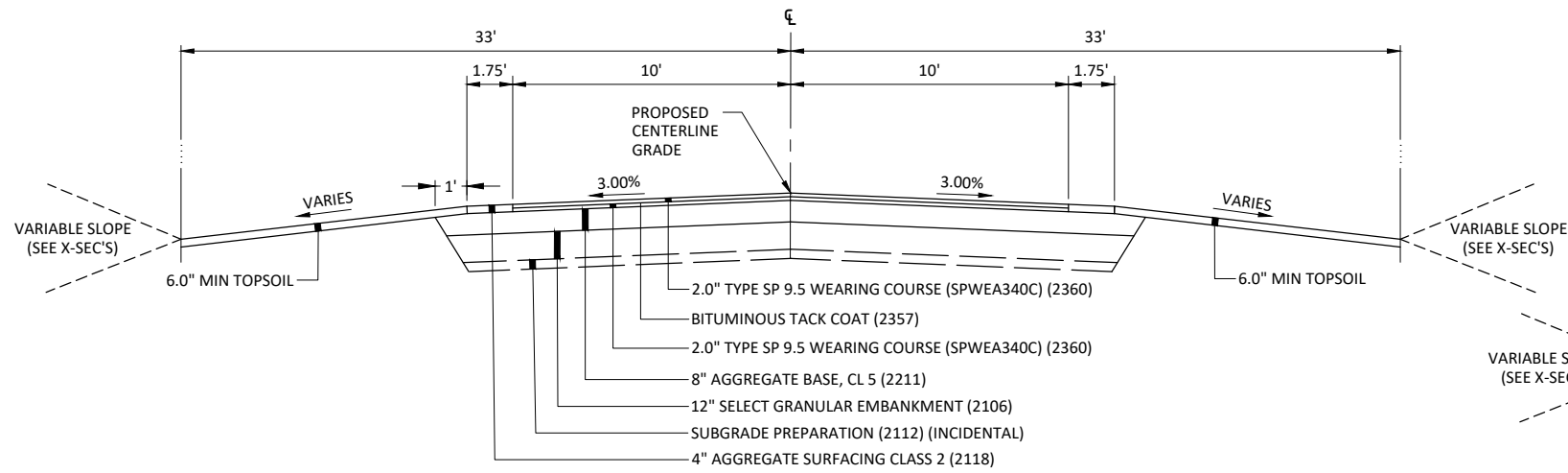

**DREDGE SITE ACCESS ROAD  
TYPICAL SECTION**

50+12.23 - 50+50

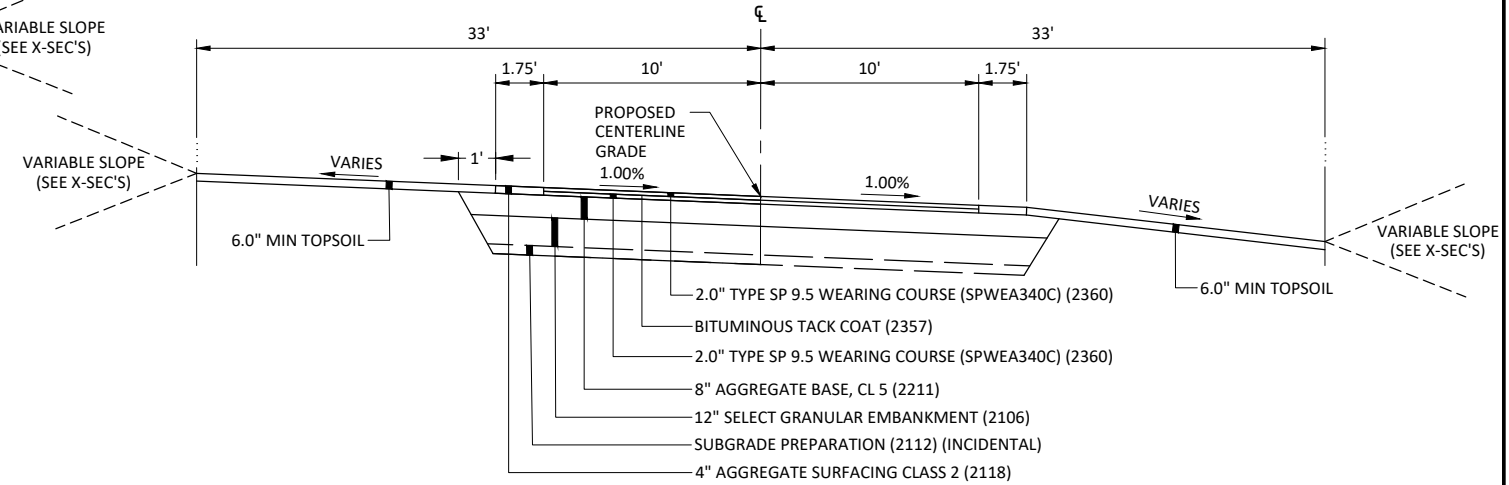

**VERNON AVENUE  
17+50 - 19+25  
TYPICAL SECTION**

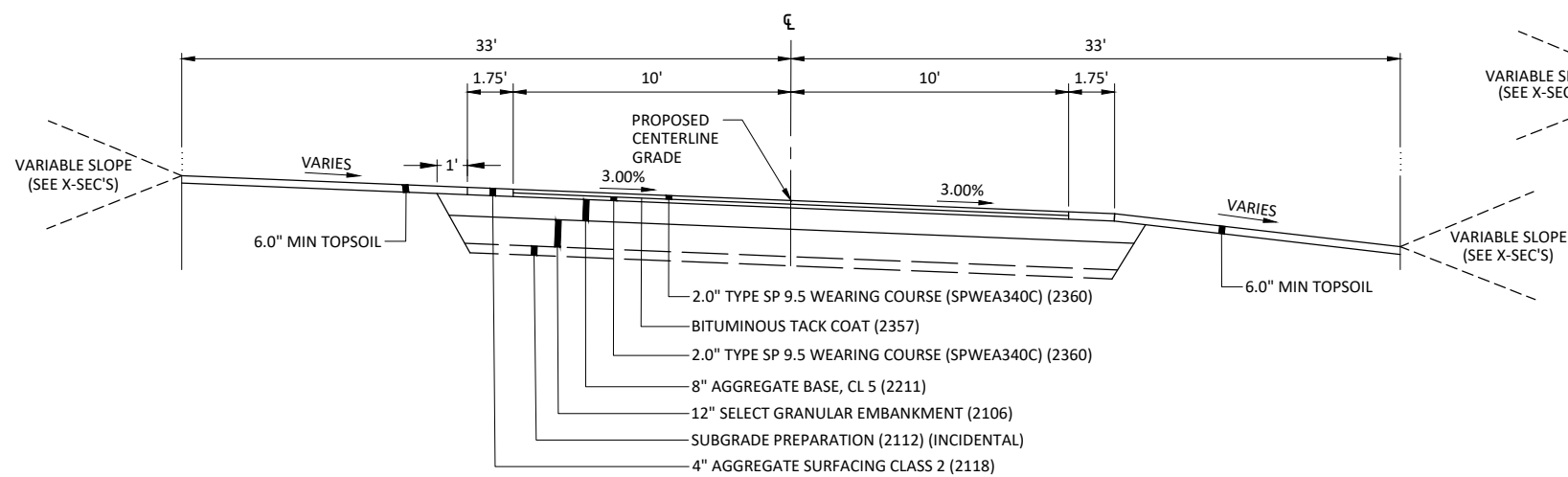

**DREDGE SITE ACCESS ROAD  
TYPICAL SECTION**

50+50 - 51+34.56

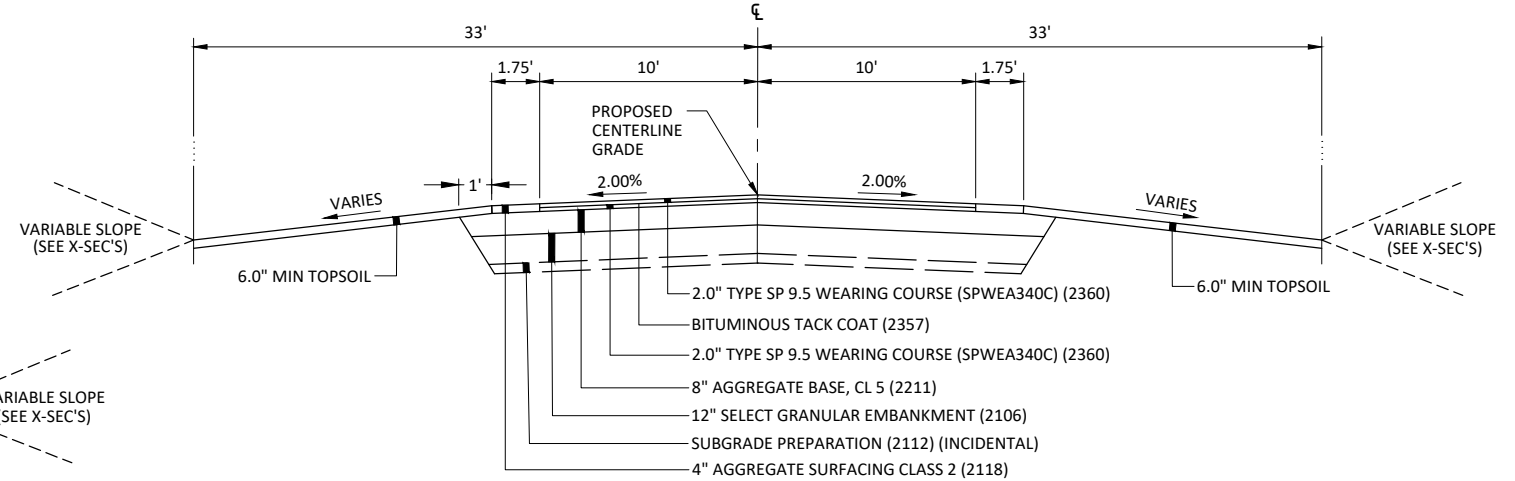

**NOTES:**

1. ANY VARIATIONS FROM THE TYPICAL SECTION DIMENSIONS ARE SHOWN ON THE PLAN DRAWINGS

© Bolton & Menk, Inc. 2023. All Rights Reserved. PLU00129866.CAD (3/21/2024 4:15:06 PM)

I HEREBY CERTIFY THAT THIS PLAN, SPECIFICATION, OR REPORT WAS PREPARED BY ME OR UNDER MY DIRECT SUPERVISION AND THAT I AM A DULY LICENSED PROFESSIONAL ENGINEER UNDER THE LAWS OF THE STATE OF MINNESOTA.  
*Bradley J Fisher*  
BRADLEY J FISHER  
LIC. NO. 56595 DATE 02/21/2024



12224 NICOLLET AVENUE  
BURNSVILLE, MINNESOTA 55337  
Phone: (952) 890-0509  
Email: Burnsville@bolton-menk.com  
www.bolton-menk.com

DESIGNED	NO.	ISSUED FOR	DATE
JLW			
DRAWN			
JLW			
CHECKED			
BJF			
CLIENT PROJ. NO.			
0T1.129866			

LOWER MINNESOTA RIVER WATERSHED DISTRICT

VERNON AVENUE IMPROVEMENTS

TYPICAL SECTION

SHEET

C1.01

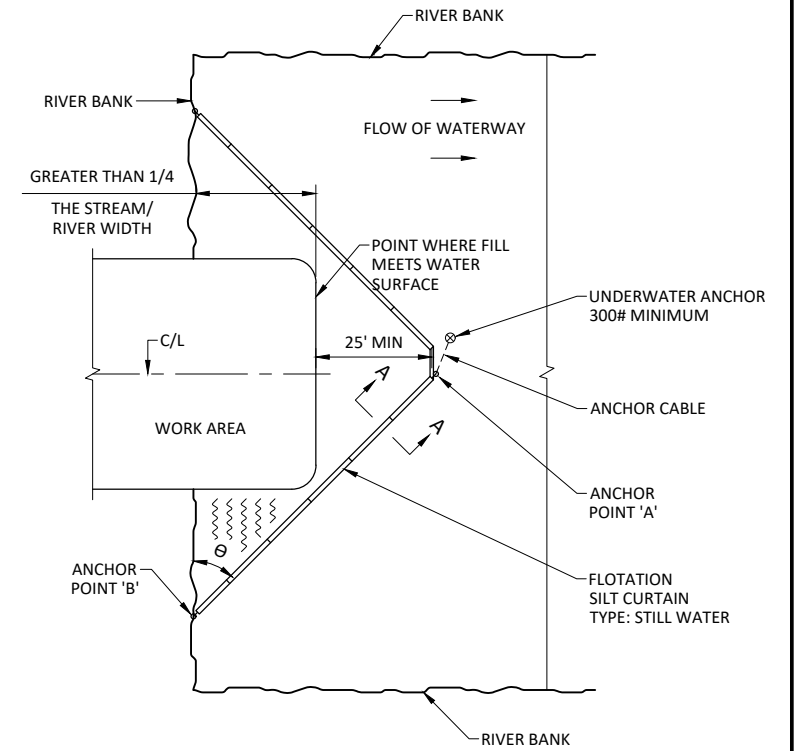
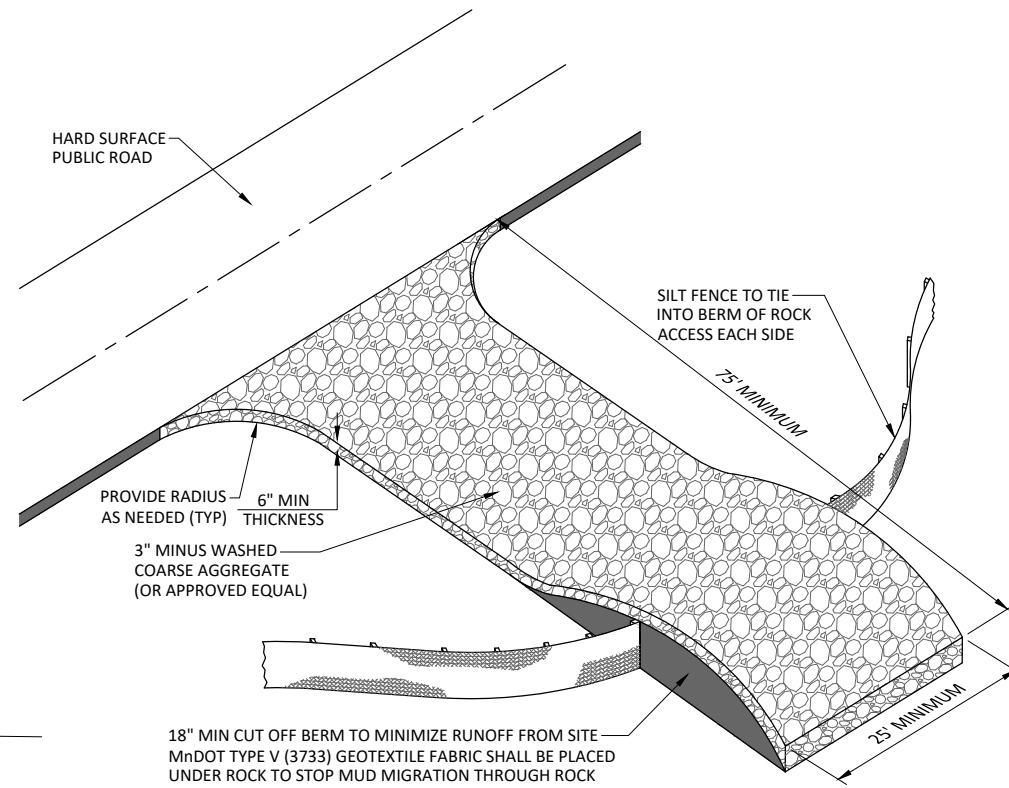
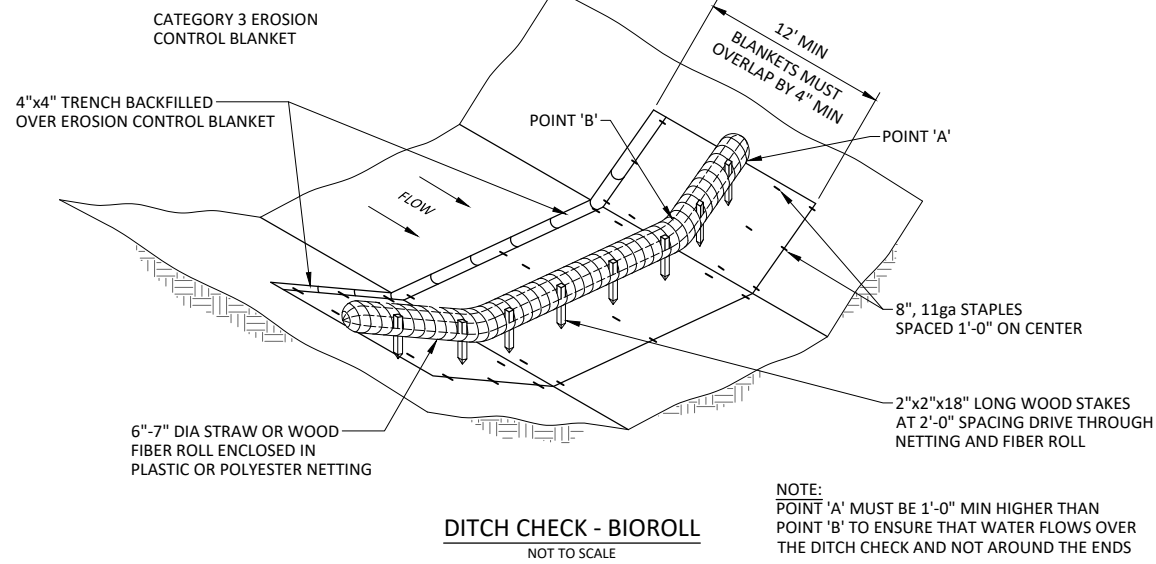

DESIGN GUIDELINES:  
WHEN TEMPORARY FILL ENCLOSES MORE THAN 1/4 BUT LESS THAN 1/3 THE WIDTH OF THE STREAM

MAXIMUM WATER DEPTH: 11 FT  
MINIMUM WATER DEPTH: 3 FT  
MAXIMUM WATER VELOCITY: 5 FT/SEC

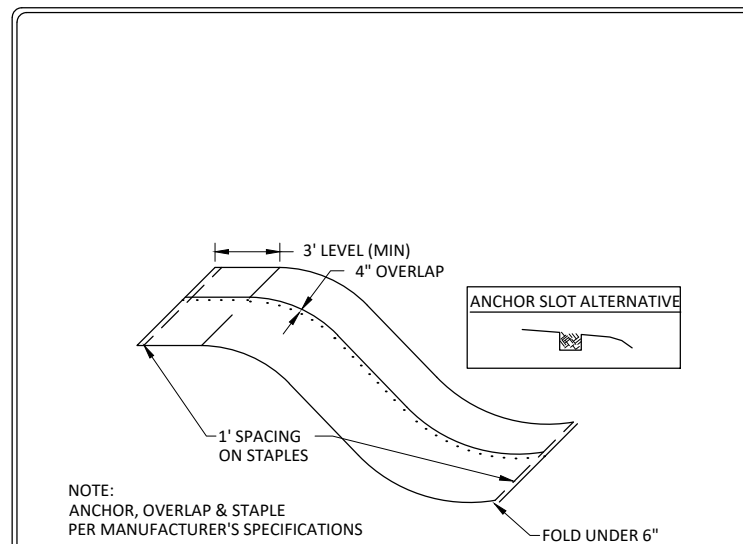
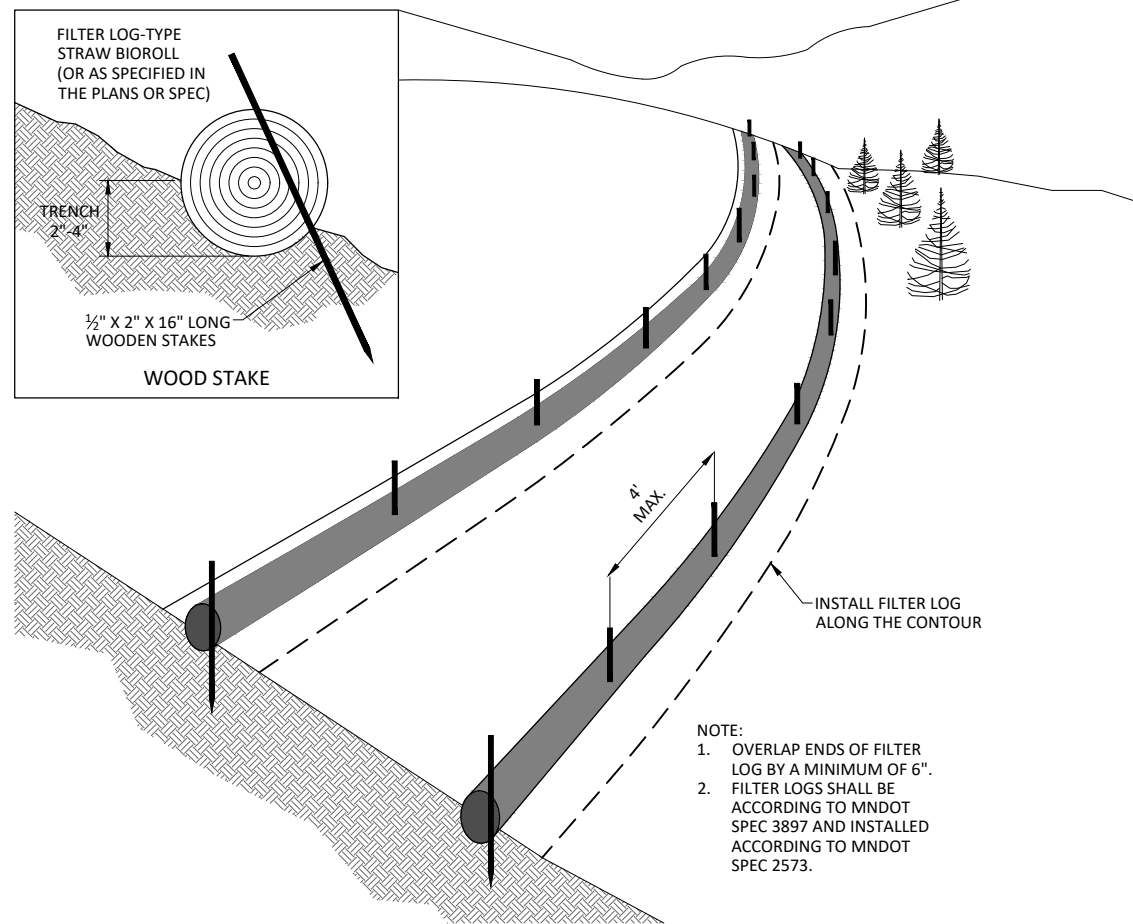
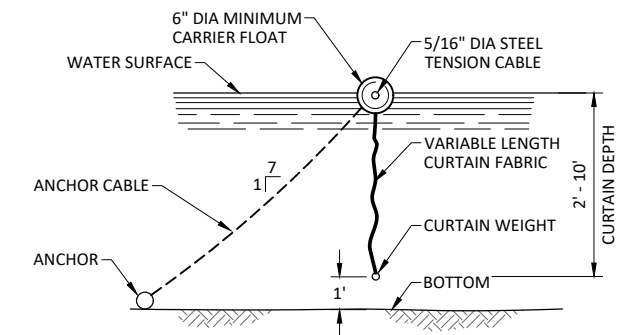

**BOLTON & MENK**

**EROSION CONTROL BLANKET INSTALLATION**  
NOT TO SCALE

LAST REVISION: 04-2021  
PLATE NO. 3-200

© Bolton & Menk, Inc. 2023. All Rights Reserved. 1/25/2024 4:15:12 PM

I HEREBY CERTIFY THAT THIS PLAN, SPECIFICATION, OR REPORT WAS PREPARED BY ME OR UNDER MY DIRECT SUPERVISION AND THAT I AM A DULY LICENSED PROFESSIONAL ENGINEER UNDER THE LAWS OF THE STATE OF MINNESOTA.

*Bradley J Fisher*  
BRADLEY J FISHER  
LIC. NO. 56595 DATE 02/21/2024



12224 NICOLLET AVENUE  
BURNSVILLE, MINNESOTA 55337  
Phone: (952) 890-0509  
Email: Burnsville@bolton-menk.com  
www.bolton-menk.com

DESIGNED	NO.	ISSUED FOR	DATE
JLW			
DRAWN			
JLW			
CHECKED			
BJF			
CLIENT PROJ. NO.			
0T1.129866			

**LOWER MINNESOTA RIVER WATERSHED DISTRICT**  
VERNON AVENUE IMPROVEMENTS

DETAILS

SHEET  
**C1.02**

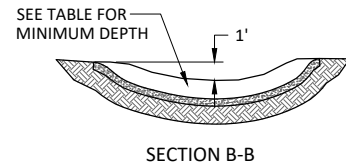

ROUND PIPE DIA (IN)	L (FT)	CLASS II	CLASS III	CLASS IV
		d50=6"	d50=9"	d50=12"
12	8	5	8	10
15	8	5	8	10
18	10	6	10	15
21	10	8	15	15
24	12	10	15	20
27	12	10	15	20
30	14	15	20	25
36	16	18	25	30
42	18	20	30	40
48	20	20	40	50

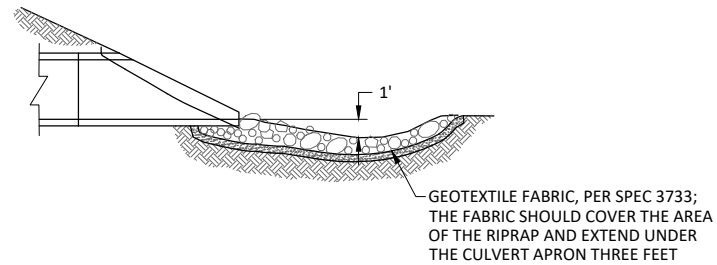
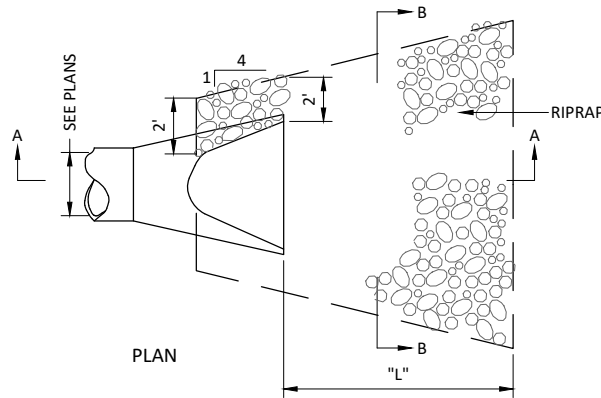

SECTION A-A  
RIPRAP AT RCP CULVERT END  
NOT TO SCALE

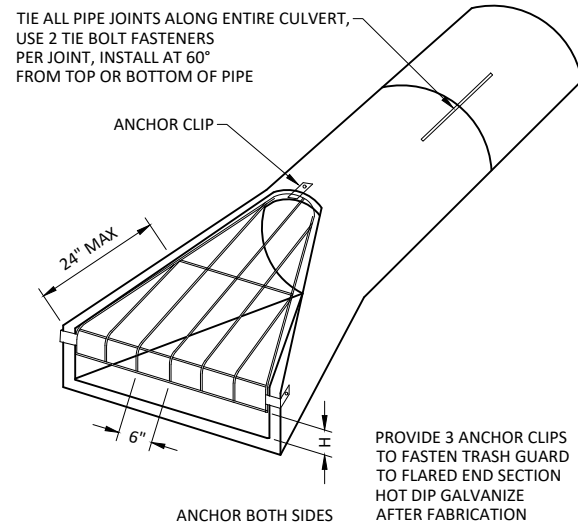

TRASH GUARD SIZES			
PIPE SIZE	BAR	"H"	BOLTS
12"-18"	3/4"Ø	4"	5/8"
21"-42"	1"Ø	6"	3/4"
42"-72"	1 1/4"Ø	12"	1"

RC APRON TRASH RACK  
(STEEL BARS)  
NOT TO SCALE

PLAN VIEW

**NOTES:**

- FOR CSP, REMOVE TEMPORARY STANDPIPE AND INSTALL CULVERT APRON AFTER VEGETATION IS ESTABLISHED.
- FOR RCP, INSTALL CULVERT APRON AND SLIDE TEMPORARY STANDPIPE INTO RCP. AFTER VEGETATION IS ESTABLISHED, REMOVE TEMPORARY STANDPIPE.
- ALL GEOTEXTILE USED FOR INLET PROTECTION SHALL BE MONOFILAMENT IN BOTH DIRECTIONS.

ELEVATION OF CSP INSTALLATION

ELEVATION OF RCP INSTALLATION

FOR SEDIMENT CONTROL ON CULVERT INLET (TYPE D SPEC. 3891)  
CULVERT SIZE: 12"-36"  
d = DIAMETER OF STANDPIPE EQUAL TO DIAMETER OF PLAN CULVERT  
L = LENGTH OF PERFORATED STANDPIPE (d+12")



**INLET PROTECTION  
CULVERT STANDPIPE**  
NOT TO SCALE

LAST REVISION:  
04-2021  
PLATE NO.  
3-110

© Bolton & Menk, Inc. 2023. All Rights Reserved. C:\LOWRIVER\MINN\_VD\PROJECTS\122986\CAD\CAD\122986\C102.dwg 1/25/2024 4:15:12 PM

I HEREBY CERTIFY THAT THIS PLAN, SPECIFICATION, OR REPORT WAS PREPARED BY ME OR UNDER MY DIRECT SUPERVISION AND THAT I AM A DULY LICENSED PROFESSIONAL ENGINEER UNDER THE LAWS OF THE STATE OF MINNESOTA.  
*Bradley J Fisher*  
BRADLEY J FISHER  
LIC. NO. 56595 DATE 02/21/2024



12224 NICOLLET AVENUE  
BURNSVILLE, MINNESOTA 55337  
Phone: (952) 890-0509  
Email: Burnsville@bolton-menk.com  
www.bolton-menk.com

DESIGNED	NO.	ISSUED FOR	DATE
JLW			
DRAWN			
JLW			
CHECKED			
BJF			
CLIENT PROJ. NO.	0T1.129866		

LOWER MINNESOTA RIVER WATERSHED DISTRICT  
VERNON AVENUE IMPROVEMENTS  
DETAILS

SHEET  
**C1.03**

PLOTTED/REVISED:  
29-JAN-2019

USER NAME: \$\$\$@USER\$NAME\$\$\$  
PATH & FILENAME: OTS\DesignStandards\Development\StandardPlans\DEV400\_Series.s441\_spn.dgn

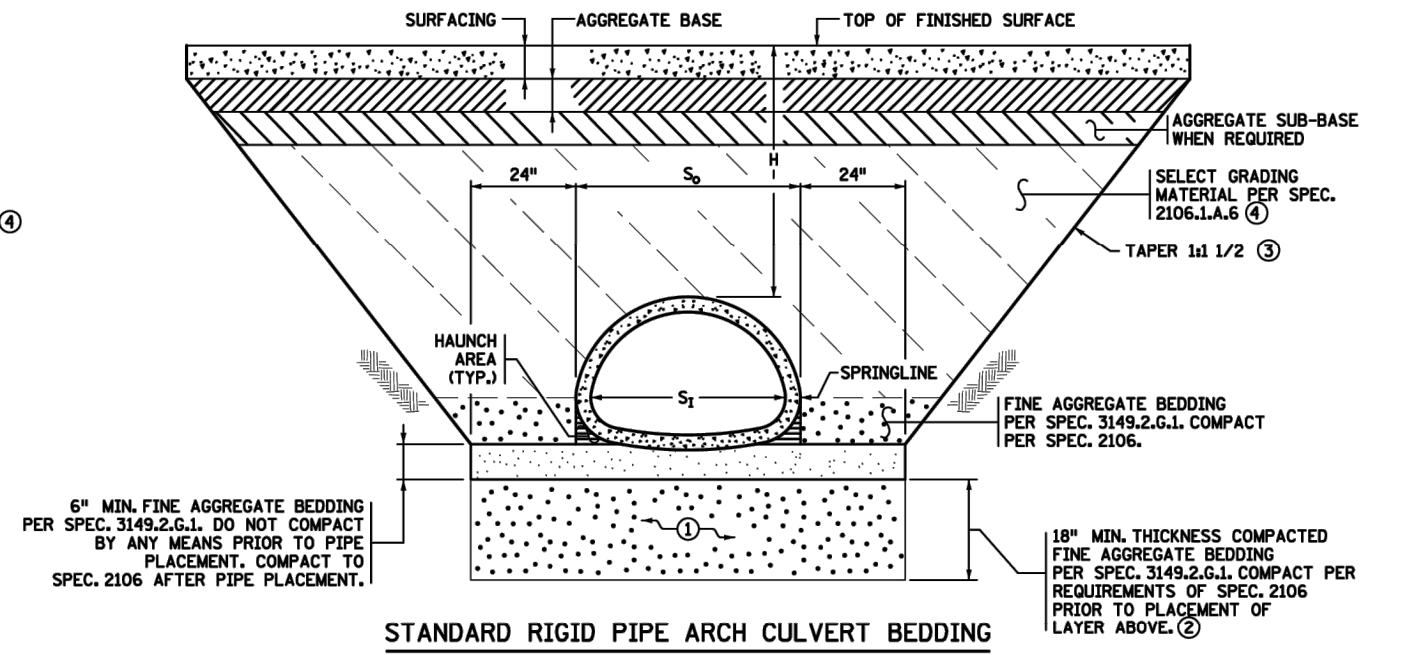
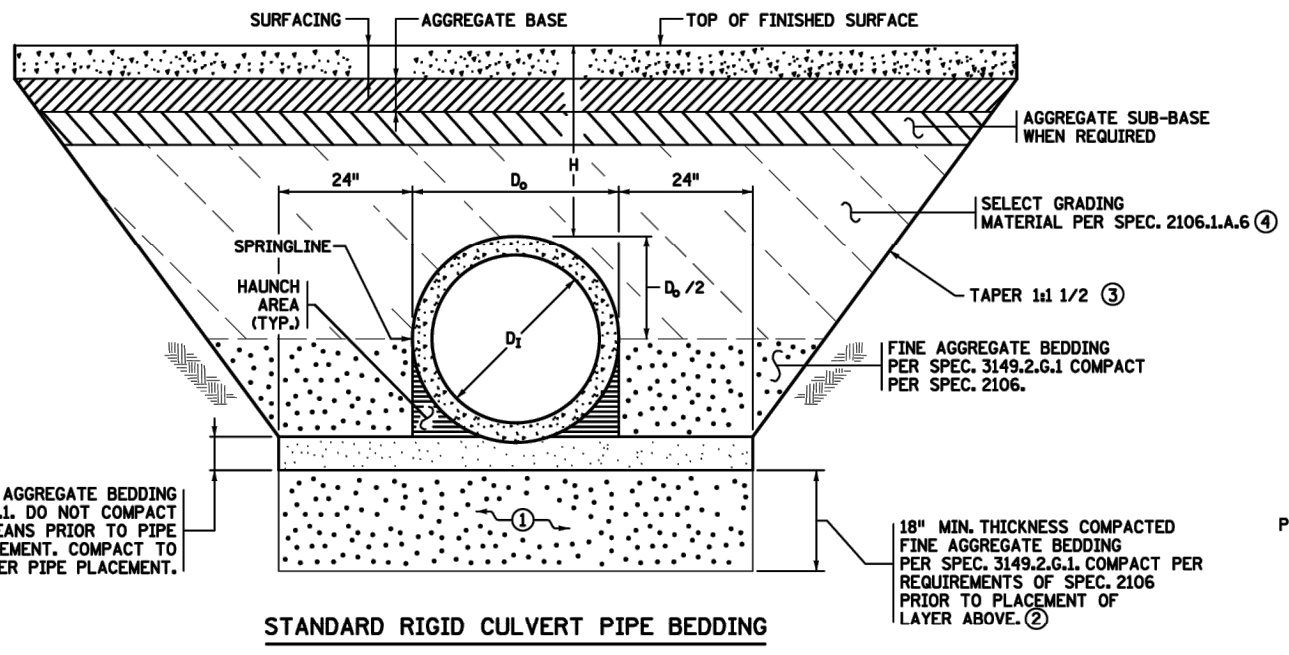

**-LEGEND-**  
 $D_1$  = INSIDE DIAMETER OF ROUND PIPE (INCHES).  
 $D_0$  = OUTSIDE DIAMETER OF ROUND PIPE (INCHES).  
 $S_1$  = INSIDE SPAN OF PIPE-ARCH (INCHES).  
 $S_0$  = OUTSIDE SPAN OF PIPE-ARCH (INCHES).  
 $H$  = FILL COVER HEIGHT OVER PIPE (FEET).  
 = UNDISTURBED SOIL  
 = COMPACTED BEDDING  
 = LOOSE BEDDING, COMPACTED AFTER PIPE PLACEMENT

**CONSTRUCTION SEQUENCE**

1. PLACE AND COMPACT 18" OF FINE AGGREGATE BEDDING TO THE REQUIREMENTS OF SPEC. 2106.
2. LOOSELY PLACE 6" OF FINE AGGREGATE BEDDING MATERIAL (SPEC. 3149.2.G.1) TO GRADE. DO NOT COMPACT PRIOR TO PIPE PLACEMENT.
3. FOR PIPES WITH BELL, REMOVE MATERIAL IN BELL AREA PRIOR TO PLACEMENT.
4. FURNISH AND INSTALL PIPE TO GRADE.
5. AFTER PLACEMENT OF THE PIPE, PLACE ADDITIONAL BEDDING AND COMPACT THE FULL LENGTH ON BOTH SIDES OF THE PIPE UNDERNEATH THE HAUNCH AREA BY FIRST SHOVEL SLICING (MANUALLY SHOVEL THE BLADE END OF A SHOVEL AT AN ANGLE DOWN THE ENTIRE LENGTH OF THE PIPE IN THE HAUNCH AREA) THEN COMPACT THE HAUNCH AT AN ANGLE USING A POWERED MECHANICAL OR PNEUMATIC DEVICE (I.E. POLE TAMPER, JUMPING JACK, OR SIMILAR).
6. COMPACT THE REMAINING MATERIAL OUTSIDE THE HAUNCH AREA TO THE REQUIREMENTS OF SPEC. 2106 ENSURING THAT THE ENTIRE LENGTH OF PIPE IS SUPPORTED UNIFORMLY BY BEDDING.
7. PLACE AND COMPACT BACKFILL EVENLY AND SIMULTANEOUSLY IN 6" LIFTS ON EACH SIDE OF THE PIPE UP TO THE SPRINGLINE WHEN COMPACTED.
8. COMPLETE REMAINING BACKFILL.

**NOTES**

- STANDARD BEDDING FOR RIGID PIPE CULVERTS WITHOUT TREATMENTS.
- RIGID PIPE INCLUDES CONCRETE.
- ENTRANCE CULVERTS (FIELD AND DRIVEWAY CULVERTS) DO NOT NEED BEDDING UNLESS SPECIFIED IN THE PLANS OR SPECIAL PROVISIONS.
- UNLESS OTHERWISE NOTED IN THE PLAN, BEDDING QUANTITIES ARE COMPUTED FOR THE FULL LENGTH OF THE PIPE AND APRON, AND WILL NOT BE ADJUSTED FOR CHANGES TO MEET OSHA REQUIREMENTS.
- WHEN RIPRAP IS REQUIRED AT THE APRON END, SEE STANDARD PLATE OR PLAN FOR RIPRAP INSTALLATION AND QUANTITIES. FOR APRONS WITHOUT RIPRAP PLACE 6" MIN. FINE AGGREGATE BEDDING UNDER APRONS. USE A TRENCH WIDTH EQUAL TO THE PIPE TRENCH WIDTH.
- CONTRACT PAY ITEM FOR FINE AGGREGATE BEDDING INCLUDES THE COST OF EXCAVATION, PLACEMENT AND COMPACTION.
- EXCAVATION AND BACKFILL WITH SELECT GRADING MATERIAL ARE NOT TABULATED SEPARATELY BUT ARE INCLUDED IN THE CONTRACT UNIT PRICE OF THE RELEVANT CULVERT PAY ITEM.
- EXCAVATE & CONSTRUCT ALL TRENCHES AND SLOPES PER OSHA REQUIREMENTS.
- ALL SLOPES SHOWN AS (V) : (H).
- PIPE SIZE IS BASED ON THE NOMINAL INSIDE DIAMETER OR SPAN.
- PROTECT ALL PIPE DURING CONSTRUCTION PER SPEC. 2501.
- PLACE MULTIPLE PIPE CULVERTS WITH A CLEARANCE OF 24 INCHES OR GREATER BETWEEN STRINGS OF PIPE.
- ① IF APPROVED BY THE ENGINEER, IN WET CONDITIONS THE CONTRACTOR MAY SUBSTITUTE 18" OF COARSE FILTER AGGREGATE PER SPEC. 3149.2.H COMPACTED TO THE QUALITY COMPACTION REQUIREMENTS OF SPEC. 2106. WRAP WITH GEOTEXTILE FABRIC TYPE IV PER SPEC. 3733. SEAM ALL FABRIC SIDES AND ENDS PER SPEC. TABLE 3733-1 INCLUDING FOOTNOTE (e) OR OVERLAP A MINIMUM OF 3 FT., ALL AT NO ADDITIONAL COST.
- ② FOR INSTALLATIONS ON INTACT BEDROCK, OMIT THIS LAYER.
- ③ OVER-EXCAVATION BENEATH TAPERS IS NOT PERMITTED UNLESS REQUIRED BY OSHA. (TYP.)
- ④ MAXIMUM EMBANKMENT PARTICLE SIZE WITHIN 2 FT. OF RIGID PIPE IS 3".

REVISION:  
 APPROVED: JANUARY 18, 2019  
*Kevin Weston*  
 STATE BRIDGE ENGINEER

	STANDARD PLAN 5-297.441	1 OF 1	STANDARD CULVERT BEDDING FOR RIGID PIPE (WITHOUT TREATMENTS)	
		APPROVED: 01-18-2019	STATE PROJ. NO.	(T.H. ) SHEET NO. OF SHEETS



12224 NICOLLET AVENUE  
 BURNSVILLE, MINNESOTA 55337  
 Phone: (952) 890-0509  
 Email: Burnsville@bolton-menk.com  
 www.bolton-menk.com

DESIGNED	NO.	ISSUED FOR	DATE
JLW			
DRAWN			
JLW			
CHECKED			
BJF			
CLIENT PROJ. NO.			
0T1.129866			

LOWER MINNESOTA RIVER WATERSHED DISTRICT  
 VERNON AVENUE IMPROVEMENTS  
 DETAILS

SHEET  
 C1.04

# STORMWATER POLLUTION PREVENTION PLAN (SWPPP)

## VERNON AVENUE IMPROVEMENTS CITY OF SAVAGE DAKOTA COUNTY, MINNESOTA

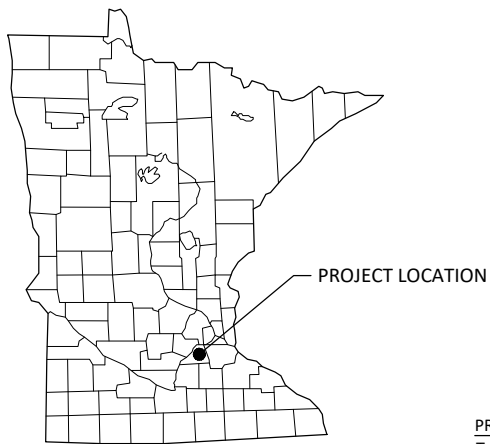

**LEGEND**

- 1-MILE BOUNDARY
- PROJECT BOUNDARY
- OR  IMPAIRED, SPECIAL OR PROTECTED WATERS
- NATIONAL WETLANDS INVENTORY
- RECEIVING WATERS

**PROJECT AREAS:**

Total Project Size (disturbed area) =	2.5	ACRES
Existing area of impervious surface =	1.9	ACRES
Post construction area of impervious surface =	1.9	ACRES
Total new impervious surface area created =	0.0	ACRES

Planned Construction Start Date: 09/01/2023  
 Estimated Construction Completion Date: 06/30/2024

**PERMANENT STORMWATER MANAGEMENT SYSTEM:**  
 Type of storm water management used if more than 1 acre of new impervious surface is created:

	Wet Sedimentation Basin
	Infiltration/Filtration
	Regional Pond
X	Permanent Stormwater Management Not Required *

\* Though this project triggers the LMRWD stormwater rule, the existence of wetlands adjacent to the road, high ground water table and lack of right-of-way preclude this project from meeting the entire volume reduction requirement on-site.

**PROJECT LOCATION:**

COUNTY	TOWNSHIP	RANGE	SECTION	LATITUDE	LONGITUDE
Dakota	27	24	31	44.77966°	-93.34994°

BMP SUMMARY	QUANTITY	UNIT
Random Riprap	80	CU YD
Stabilized Construction Exit	1	LUMP SUM
Storm Drain Inlet Protection	3	EACH
Flotation Silt Curtain	40	LIN FT
Sediment Control Log	14000	LIN FT
Seed & Blanket	5130	SQ YD

**DESCRIPTION OF CONSTRUCTION ACTIVITIES AND STORMWATER MANAGEMENT:**  
 Construction activities include: Removals, site grading, culvert replacement, bituminous paving, temporary erosion and sediment control, and permanent stabilization.

Stormwater currently runs off the road into ditched wetlands on either side of the road where it flows into Credit River and/or the Minnesota River.

After construction is complete stormwater will continue to drain in the same direction as in the existing condition. The existing drainage patterns will be maintained.

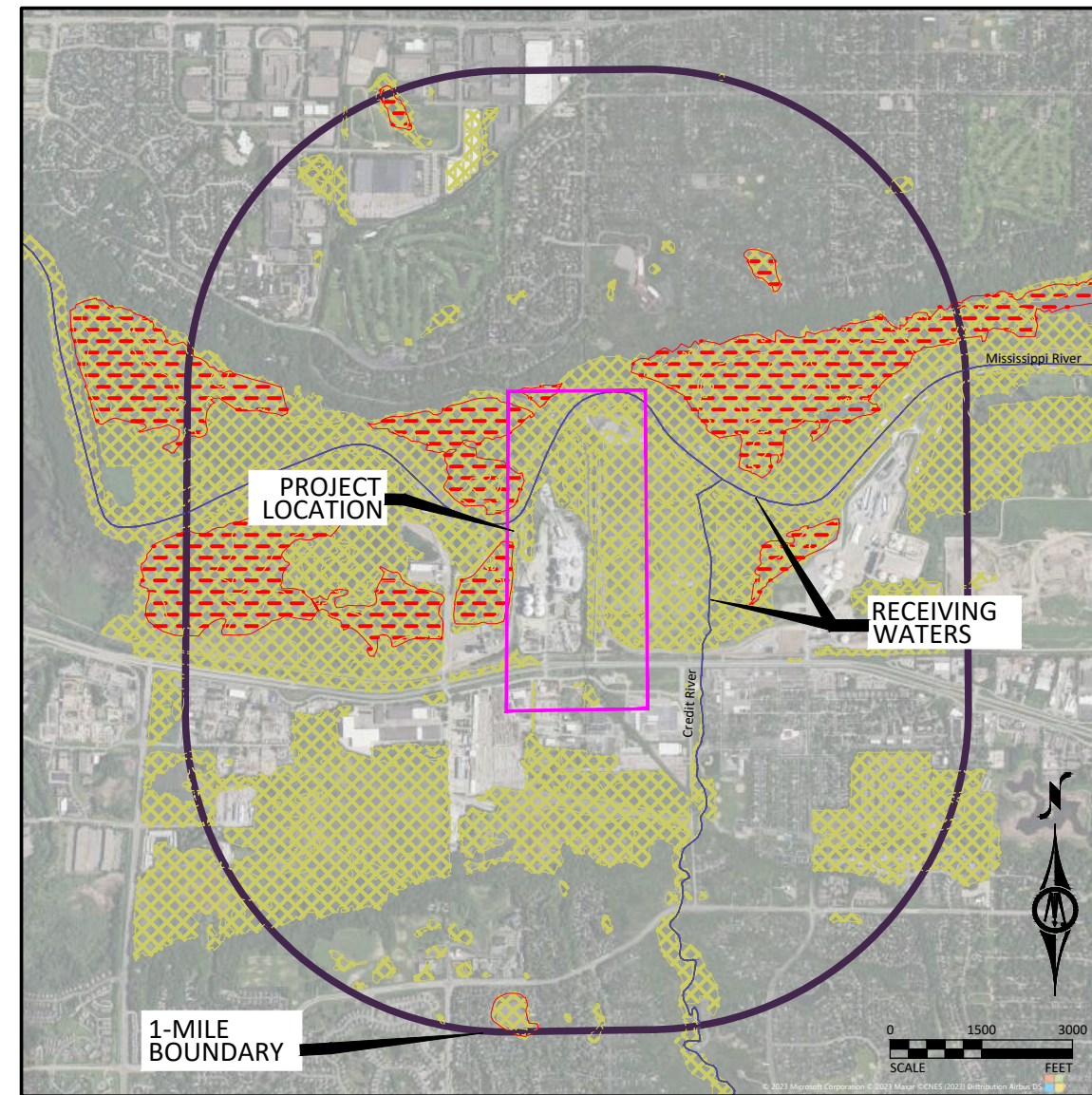

**RECEIVING WATERS:**  
 Receiving waters, including surface water, wetlands, Public Waters, and stormwater ponds, within 1-mile of the project boundary are identified on the USGS 7.5 min quad map above. Receiving waters that are impaired, the impairment, and WLA are listed as follows. All specific BMPs relative to construction activities listed in the permit for special, prohibited, restricted, or impaired have been incorporated into this plan. All specific BMPs listed in approved TMDLs and those BMPs listed for construction related waste load allocations have also been incorporated.

NAME OF WATER BODY	TYPE (ditch, pond, wetland, lake, etc.)	Special, Prohibited, Restricted Water <sup>1</sup>	Flows to Impaired Water Within 1-Mile <sup>2</sup>	USEPA Approved Construction Related TMDL <sup>3</sup>
Credit River	River	No	Yes	Yes
Minnesota River	River	No	Yes	Yes

<sup>1</sup> Special, prohibited, and restricted waters are listed in Section 23 of the MN Construction Stormwater General Permit (MNR100001).  
<sup>2</sup> Identified as impaired under section 303 (d) of the federal Clean Water Act for phosphorus, turbidity, TSS, dissolved oxygen, and/or aquatic biota.  
<sup>3</sup> Construction Related TMDLs include those related to: phosphorus, turbidity, TSS, dissolved oxygen, and/or aquatic biota.

**IMPLEMENTATION SCHEDULE AND PHASING:** The Contractor is required to provide an updated schedule and site management plan meeting the minimum requirements of Section 1717 of the Minnesota Standard Specifications for Construction.

- Submit SWPPP Updates to Engineer. Submittal shall include any requested changes to the SWPPP, including but not limited to: Trained Personnel, Locations for Stockpiles, Concrete Washout, Sanitation Facilities, Types and Locations of Erosion & Sediment Control. Failure to submit updates shall be considered acceptance of the SWPPP as designed with no changes.
- Install perimeter sediment control, inlet protection, and construction exit.
- Removal of existing bituminous pavements.
- Construction of stormwater management features.
- Add additional temporary BMPs as necessary during construction based on inspection reports.
- Installation of new gravel and sand roadway sections.
- Paving the roadway with bituminous pavement.
- Permanent final stabilization measures such as sod, hydroseed, and erosion control blanket.
- Add additional temporary BMPs as necessary during construction based on inspection reports.
- Ensure final stabilization measures are complete.
- Provide digital copy of all Field SWPPP Documentation including Inspection Reports and SWPPP Revisions to the Owner.
- Submit Notice of Termination (NOT) to MPCA. NOTE: All construction activity and final stabilization must be considered complete prior to submitting the NOT to the MPCA.

**RESPONSIBLE PARTIES:**  
 The Contractor and Owner will be joint applicants under the MPCA's General Stormwater Permit for Construction Activity as required by the National Pollutant Discharge Elimination System (NPDES) Phase II program.

The Contractor shall provide one or more trained Construction SWPPP Manager(s) knowledgeable and experienced in the application of erosion prevention and sediment control BMPs that will oversee the implementation of the SWPPP, and the installation, inspection and maintenance of the erosion prevention and sediment control BMPs.

A Construction SWPPP Manager must be available for an on-site inspection within 72 hours upon request by the MPCA.

	COMPANY	CONTACT PERSON	PHONE
OWNER:	Lower MN River Watershed District	Linda Loomis	763-568-9522
OWNER'S REPRESENTATIVE	Young Environmental Consulting Group	Hannah LeClaire, P.E.	763-568-0726
SWPPP DESIGNER:	Bolton & Menk, Inc.	Lanol Leichty, P.E.	952-890-0509
CONTRACTOR:	TBD	TBD	TBD
CONSTRUCTION SWPPP MANAGER:	TBD	TBD	TBD
PARTY RESPONSIBLE FOR LONG TERM O&M:	Lower MN River Watershed District	Linda Loomis	763-568-9522

The SWPPP Designer, Construction SWPPP Manager, and BMP Installer must have appropriate training. Documentation showing training commensurate with the job duties and responsibilities is required to be included in the SWPPP prior to any work beginning on the site. Training documentation for the SWPPP Designer is included on the Narrative sheet. The Contractor shall attach training documentation to this SWPPP for the Construction SWPPP Manager and BMP Installer prior to the start of construction. This information shall be kept up to date until the project NOT is filed.

**ADDITIONAL COMPENSATION**  
 Payment for all work associated with Erosion and Sediment Control shall be as described in the Project Manual. Unless otherwise authorized by the Owner no additional payment shall be made for any work required to administer and maintain the site erosion and sediment control in compliance with the Minnesota Pollution Control Agency (MPCA) - General Stormwater Permit for Construction Activity (MN R100001) including but not limited to inspection, maintenance, and removal of BMPs or addition of BMPs to accommodate Contractor phasing.

**DOCUMENT RETENTION**  
 The SWPPP, including any modifications made to it, must be kept on-site during normal working hours. Permittees must make the SWPPP, including all inspection reports, maintenance records, training records and other information required by this permit, available to federal, state, and local officials within three (3) days upon request for the duration of the permit and for three (3) years following the NOT.

**GENERAL STORMWATER DISCHARGE REQUIREMENTS**  
 All requirements listed in Section 5.1 of the Permit for the design of the permanent stormwater management system and discharge have been included in the preparation of this SWPPP. These include but are not limited to:

- The expected amount, frequency, intensity, and duration of precipitation.
- The nature of stormwater runoff and run-on at the site
- Peak flow rates and stormwater volumes to minimize erosion at outlets and downstream channel and stream bank erosion.
- The range of soil particle sizes expected to be present on the site.

Permanent stormwater treatment systems for this project have been designed in accordance with the guidance in the MN Stormwater Manual in place at the time of bidding. Copies of the design information and calculations are part of this SWPPP and will be provided in digital format upon written request to the Engineer.

© Bolton & Menk, Inc. 2023. All Rights Reserved. PROJECT NO. 2023-00112-3865 (LAD) (LAD) 1/25/2024 4:13:28 PM

I HEREBY CERTIFY THAT THIS PLAN, SPECIFICATION, OR REPORT WAS PREPARED BY ME OR UNDER MY DIRECT SUPERVISION AND THAT I AM A DULY LICENSED PROFESSIONAL ENGINEER UNDER THE LAWS OF THE STATE OF MINNESOTA.

*Bradley J Fisher*  
 BRADLEY J FISHER  
 LIC. NO. 56595 DATE 02/21/2024

**BOLTON & MENK**  
 12224 NICOLLET AVENUE  
 BURNSVILLE, MINNESOTA 55337  
 Phone: (952) 890-0509  
 Email: Burnsville@bolton-menk.com  
 www.bolton-menk.com

DESIGNED	NO.	ISSUED FOR	DATE
JLW			
DRAWN			
JLW			
CHECKED			
BJF			
CLIENT PROJ. NO.	011.129866		

LOWER MINNESOTA RIVER WATERSHED DISTRICT  
 VERNON AVENUE IMPROVEMENTS  
 STORMWATER POLLUTION PREVENTION PLAN  
 SWPPP PLAN

SHEET  
**C2.01**

Information contained in this SWPPP narrative sheet summarizes requirements of the GENERAL PERMIT AUTHORIZATION TO DISCHARGE STORMWATER ASSOCIATED WITH CONSTRUCTION ACTIVITY UNDER THE NATIONAL POLLUTANT DISCHARGE ELIMINATION SYSTEM/STATE DISPOSAL SYSTEM PROGRAM - Permit No: MN R100001 (Permit) as they apply to this project. All provisions of the Permit including those not specifically cited herein shall apply to this project. The Contractor is responsible to be familiar with and comply with all conditions of the permit. The full text of the Permit is available at: <https://www.pca.state.mn.us/sites/default/files/wq-strm2-80a.pdf>

**SWPPP AMENDMENTS AND SUBMITTALS**

Contractor must prepare and submit to the Engineer a SWPPP amendment as necessary to include additional Best Management Practices (BMPs) to correct problems identified or address the following situations.

1. Contact information and training documentation for Construction SWPPP Manager and BMP Installer,
2. There is a change in construction method of phasing, operation, maintenance, weather or seasonal conditions not anticipated during the design of the SWPPP including but not limited to:
  - a. Types and/or Locations of BMPs
  - b. Material Storage and Spill Response
  - c. Fueling Plans
  - d. Locations for Stockpiles, Concrete Washout, and Sanitation Facilities and
  - e. Project Phasing
3. It is determined that the SWPPP is not achieving objectives of minimizing pollutants in stormwater discharges associated with construction activity, or
4. The SWPPP is not consistent with the terms and conditions of the permit.

The Contractor may implement SWPPP amendments immediately and is not required to wait for Engineer review of the submittal. The responsibility for completeness of SWPPP amendments and compliance with the Permit lies with the Contractor. Review, comment, or lack of comment by the Engineer on a SWPPP amendment shall not absolve the responsibilities of the Contractor in any way.

If a change order is issued for a design change the SWPPP amendment will be prepared by the Engineer and included in the change order.

In addition to SWPPP amendments, the Contractor shall submit to the Engineer Weekly Erosion and Sediment Control Schedule meeting the requirements of MnDOT 1717.

The Contractor shall keep copies of all SWPPP amendments, Weekly Erosion and Sediment Control Schedules, inspection logs, and maintenance logs with the field copy of the SWPPP. A PDF copy of these documents will be provided along with a copy of the final Field Copy of the SWPPP to the Engineer along with the signed Notice of Termination when final stabilization is complete.

**EROSION PREVENTION PRACTICES**

Stormwater conveyance channels shall be routed around unstabilized areas. Erosion controls and velocity dissipation devices shall be used at outlets within and along the length of any constructed conveyance channel.

The normal wetted perimeter of all ditches or swales, including storm water management pond slopes, that drain waters from the site must be stabilized within 200' of any property edge or discharge point, including storm sewer inlets, within 24 hours of connection.

Temporary or permanent ditches or swales used as sediment containment during construction do not need to be stabilized during temporary period of use and shall be stabilized within 24 hours after no longer used as sediment containment.

Mulch, hydromulch, tackifier, or similar practice shall not be used in any portion of the wetted perimeter of a temporary or permanent drainage ditch or swale section with a continuous slope of greater than 2 percent.

Energy dissipation shall be installed at all temporary or permanent pipe outlets within 24 hours of connection to a surface water or permanent stormwater treatment system.

The Contractor shall phase construction and use construction methods to the extent practical to minimize exposed soils. The project phasing shall be documented in the Weekly Erosion and Sediment Control Schedule.

**SEDIMENT CONTROL PRACTICES**

Down gradient BMPs including perimeter BMPs must be in place before up gradient land- disturbing activities begin and shall remain in place until final stabilization.

All BMPs that have been adjusted or removed to accommodate short-term activities shall be re-installed or replaced the earlier of the end of the work day or before the next precipitation event even if the activity is not complete.

Inlet BMPs may be removed for specific safety concerns. The BMPs shall be replaced as soon as the safety concern is resolved. The removal shall be documented in the SWPPP as a SWPPP amendment.

Temporary stockpiles must have sediment control BMPs. The Contractor shall prepare and submit to the Engineer a SWPPP amendment showing the location of temporary stockpiles and the BMPs for each stockpile. The SWPPP amendment must meet the minimum requirements of Section 9 of the Permit.

Soil compaction shall be minimized and topsoil shall be preserved, unless infeasible or if construction activities dictate soil compaction or topsoil stripping.

The use of polymers, flocculants, or other sedimentation treatment chemicals are not proposed as part of this SWPPP as designed by the Engineer. If methods or phasing of construction require the use of any of these chemicals, the Contractor shall prepare and submit to the Engineer a SWPPP amendment that meets the minimum requirements of Section 9 of the Permit.

**TEMPORARY SEDIMENTATION BASINS**

A temporary sedimentation basin has not been included in this SWPPP as designed by the Engineer. If a basin is later determined to be desirable or necessary the Contractor shall prepare and submit to the Engineer a SWPPP amendment. Temporary sedimentation basins shall meet or exceed the minimum requirements of Section 14 of the Permit and shall include a basin draining plan meeting or exceeding the minimum requirements of Section 10 of the Permit. Where the site discharges to Special and/or Impaired Waters the SWPPP amendment shall also meet or exceed the minimum requirements of Section 23 of the permit.

**DEWATERING**

A dewatering plan has not been included in this SWPPP as designed by the Engineer. If dewatering is required for this project, the Contractor shall prepare and submit to the Engineer a SWPPP amendment. All dewatering shall meet or exceed the minimum requirements of Section 10 of the Permit.

CONTRACTOR TO CONSTRUCT COFFERDAMS ON BOTH ENDS OF THE CULVERT, AS NECESSARY TO DEWATER THE CULVERT WORK AREA SUFFICIENTLY TO CONSTRUCT THE IMPROVEMENTS AS REQUIRED (OR APPROVED ALTERNATIVE METHOD). THE CONTRACTOR SHALL SUBMIT A PROPOSED DEWATERING PLAN, AND THE METHODS TO BE USED, TO THE ENGINEER FOR REVIEW AND APPROVAL PRIOR TO COMMENCING THE WORK. THE PROPOSED DEWATERING PLAN SHALL BE IN COMPLIANCE WITH SECTION 10 OF THE NPDES/SDS PERMIT MNR100001.

**POLLUTION PREVENTION**

Products and materials that have the potential to leach pollutants that are stored on the site must be stored in a manner designed to minimize contact with stormwater. Materials that are not a source of potential contamination to stormwater or that are designed for exposure to stormwater are not required to be covered.

Hazardous materials including but not limited to pesticides, fertilizer, petroleum products, curing compounds and toxic waste must be properly stored and protected from stormwater exposure as recommended by the manufacturer in an access restricted area.

Solid waste must be stored, collected and disposed of in compliance with Minnesota Administrative Rules Chapter 7035.

Portable toilets must be positioned so that they are secure and will not be tipped or knocked over. Sanitary waste must be disposed of properly in accordance with Minn. R. CH 7041.

Exterior vehicle or equipment washing on the project site shall be limited to a defined area of the site. No engine degreasing is allowed on site. A sign must be installed adjacent to each washout facility that requires site personnel to utilize the proper facilities for disposal of concrete and other washout wastes.

If contaminated soils are discovered during grading operations, the contractor must immediately suspend work and notify the engineer and owner.

Spill Containment: Contractor/Erosion Control Supervisor must make a spill response plan before the application of any chemical that may be harmful to the environment. All spills must be reported immediately. Spill cleanup must be available on site. Material shall include, but not limited to brooms, mops, rags, gloves, absorbent material, plastic and metal containers. Spills that reach storm water conveyance systems connected to a water of the state must be immediately report to the MPCA State Duty Officer at 1-800-422-0798.

Contaminated Properties: The MPCA's "What's In My Neighborhood" database (<https://mpca.maps.arcgis.com/apps/webappviewer/index.html?id=9d45793c75644e05bac197525f633f87>) was reviewed on 7/21/2023. The results of this review showed no known contaminated properties or leak sources within the project limits. Past incidents have been reported within close proximity to the project site. Any discharges observed should be recorded, photographed and described as to the location of the discharge (i.e., color, odor, oil sheen, and other obvious indicators of pollutants).

If an illicit discharge is noticed the Minnesota Department of Public Safety Duty Officer at 1-800-422-0798 (toll free) or 651-649-5451 (Metro area) should be notified immediately if the source of the illicit discharge is a spill or leak as defined in Minn. Stat. 115.061.

The Contractor shall prepare and submit a SWPPP amendment detailing the location and BMPs proposed for storage of materials, solid waste, portable toilets, and exterior vehicle or equipment washing on the site. The SWPPP amendment shall include a spill prevention and response plan that is appropriate for the materials proposed to be on the site. The SWPPP amendment shall meet or exceed the minimum requirements of Section 12 of the Permit.

Concrete Washout: Concrete washout operations must be contained in a leak proof containment facility or impermeable liner and must be performed in accordance with part 12.9 of the NPDES/SDS Program MNR 10001.

**INSPECTION & MAINTENANCE**

A trained person shall routinely inspect the entire construction site at the time interval indicated on this sheet of the SWPPP during active construction and within 24-hours after a rainfall event greater than 0.5 inches in 24 hours. Following an inspection that occurs within 24-hours after a rainfall event, the next inspection must be conducted at the time interval indicated in the Receiving Waters Table found on the SITE PLAN AND INFORMATION SHEET of the SWPPP.

All inspections and maintenance conducted during construction must be recorded on the day it is completed and must be retained with the SWPPP. Inspection report forms are available in the Project Specifications. Inspection report forms other than those provided shall be approved by the engineer.

The Contractor may request a change in inspection schedule for the following conditions:

- a. Inspections of areas with permanent cover to be reduced to once per month,
- b. Inspections of areas that have permanent cover and have had no construction activity for 12 months to be suspended until construction resumes,
- c. Inspections of areas where construction is suspended due to frozen ground conditions, inspections to be suspended until the earlier of within 24 hours of runoff occurring, or upon resuming construction.

No change in inspection schedule shall occur until authorized by the Engineer.

Inspections must include:

1. All erosion prevention and sediment control BMPs and Pollution Prevention Management Measures to ensure integrity and effectiveness.
2. Surface waters, including drainage ditches and conveyance systems for evidence of erosion and sediment deposition.
3. Construction site vehicle exit locations, streets and curb and gutter systems within and adjacent to the project for sedimentation from erosion or tracked sediment from vehicles.
4. Infiltration areas to ensure that no sediment from ongoing construction activity is reaching the infiltration area and that equipment is not being driven across the infiltration area.

All non-functioning BMPs and those BMPs where sediment reaches one-half (1/2) of the depth of the BMP, or in the case of sediment basins one-half (1/2) of the storage volume, must be repaired, replaced, or supplemented by the end of the next business day after discovery, or as soon as field conditions allow.

Permittees must repair, replace or supplement all nonfunctional BMPs with functional BMPs by the end of the next business day

after discovery, or as soon as field conditions allow.

Any sediment that escapes the site must be removed and the area stabilized within 7 calendar days of discovery unless precluded by legal, regulatory, or physical access in which case the work shall be completed within 7 calendar days of authorization. Paved surfaces such as streets shall have any escaped or tracked sediment removed by the end of the day that it is discovered. Sediment release, other than paved surfaces that can be cleaned up with street sweeping shall be reported immediately upon discovery to the Engineer.

**PUBLIC WATER RESTRICTIONS:**

For public waters that have been promulgated "work in water restrictions" during fish spawning time frames, all exposed soil areas that are within 200 feet of the water's edge, and drain to these waters must complete stabilization within 24-hours during the time period. MN DNR permits are not valid for work in waters that are designated as infested waters unless accompanied by an Infested Waters Permit or written notification has been obtained from MN DNR stating that such permit is not required. There is no exception for pre-existing permits. If a MN DNR Permit has been issued for the project and the water is later designated as infested, the Contractor shall halt all work covered by the MN DNR Permit until an Infested Waters Permit is obtained or that written notification is obtained stating that such permit is not required.

**FINAL STABILIZATION**

Final Stabilization is not complete until all the following requirements have been met:

1. Substantial Completion has been reached and no ground disturbing activities are anticipated.
2. Permanent cover has been installed with an established minimum uniform perennial vegetation density of 70 percent of its expected final growth. Vegetation is not required in areas where no vegetation is proposed by this project such as impervious surfaces or the base of a sand filter.
3. Accumulated sediment has been removed from all permanent stormwater treatment systems as necessary to ensure the system is operating as designed.
4. All sediment has been removed from conveyance systems
5. All temporary synthetic erosion prevention and sediment control BMPs have been removed. BMPs designated on the SWPPP to remain to decompose on-site may remain.
6. For residential construction only, permit coverage terminates on individual lots if the structures are finished and temporary erosion prevention and downgradient perimeter control is complete, the residence sells to the homeowner, and the permittee distributes the MPCA's "Homeowner Fact Sheet" to the homeowner.
7. For agricultural land only (e.g., pipelines across cropland), the disturbed land must be returned to its preconstruction agricultural use prior to submitting the NOT.
8. All previous soil surfaces that are compacted during construction must be decompacted through soil amendments and/or ripping to a depth of 18-inches.

**SITE STABILIZATION COMPLETION:**

Stabilization of exposed soils shall begin immediately and shall be completed after the construction activity has temporarily or permanently ceased no later than:	7 calendar days
--	-----------------

**SITE INSPECTION INTERVAL:**

A trained person shall routinely inspect the entire construction site during active construction at an interval of no more than:	7 calendar days
--	-----------------

**SPECIAL ENVIRONMENTAL CONSIDERATIONS AND PERMITS:**

1)	Was an environmental review required for this project or any part of a common plan of development or sale that includes all or any portion of this project?	NO
2)	Does any portion of the site have the potential to affect threatened or endangered species or their critical habitat?	NO
3)	Does any portion of this site discharge to a Calcareous fen.	NO
4)	Will any portion of the site potentially affect properties listed on the National Register of Historic Places or a known or discovered archeological site?	NO
5)	Have any Karst features have been identified in the project vicinity?	NO
6)	Is compliance with temporary or permanent stormwater management design requirements infeasible for this project?	YES
7)	Has the MN DNR promulgated "work in water restrictions" for any Public Water this site discharges to during fish spawning?	NO

TYPE OF PERMIT	PERMITTING AGENCY	PERMIT STATUS AND CONDITIONS
Construction Stormwater NPDES	MPCA	To be obtained

**SWPPP DESIGNER TRAINING DOCUMENTATION:**

SWPPP DESIGNER TRAINING DOCUMENTATION:  
I certify that I have completed the Design of Construction SWPPP course. The certification expires 2026.

I HEREBY CERTIFY THAT THIS PLAN, SPECIFICATION, OR REPORT WAS PREPARED BY ME OR UNDER MY DIRECT SUPERVISION AND THAT I AM A DULY LICENSED PROFESSIONAL ENGINEER UNDER THE LAWS OF THE STATE OF MINNESOTA.  
*Bradley J. Fisher*  
SIGNER'S NAME  
LIC. NO. 20846 DATE 06/19/2023

I HEREBY CERTIFY THAT THIS PLAN, SPECIFICATION, OR REPORT WAS PREPARED BY ME OR UNDER MY DIRECT SUPERVISION AND THAT I AM A DULY LICENSED PROFESSIONAL ENGINEER UNDER THE LAWS OF THE STATE OF MINNESOTA.  
*Bradley J. Fisher*  
BRADLEY J FISHER  
LIC. NO. 56595 DATE 02/21/2024







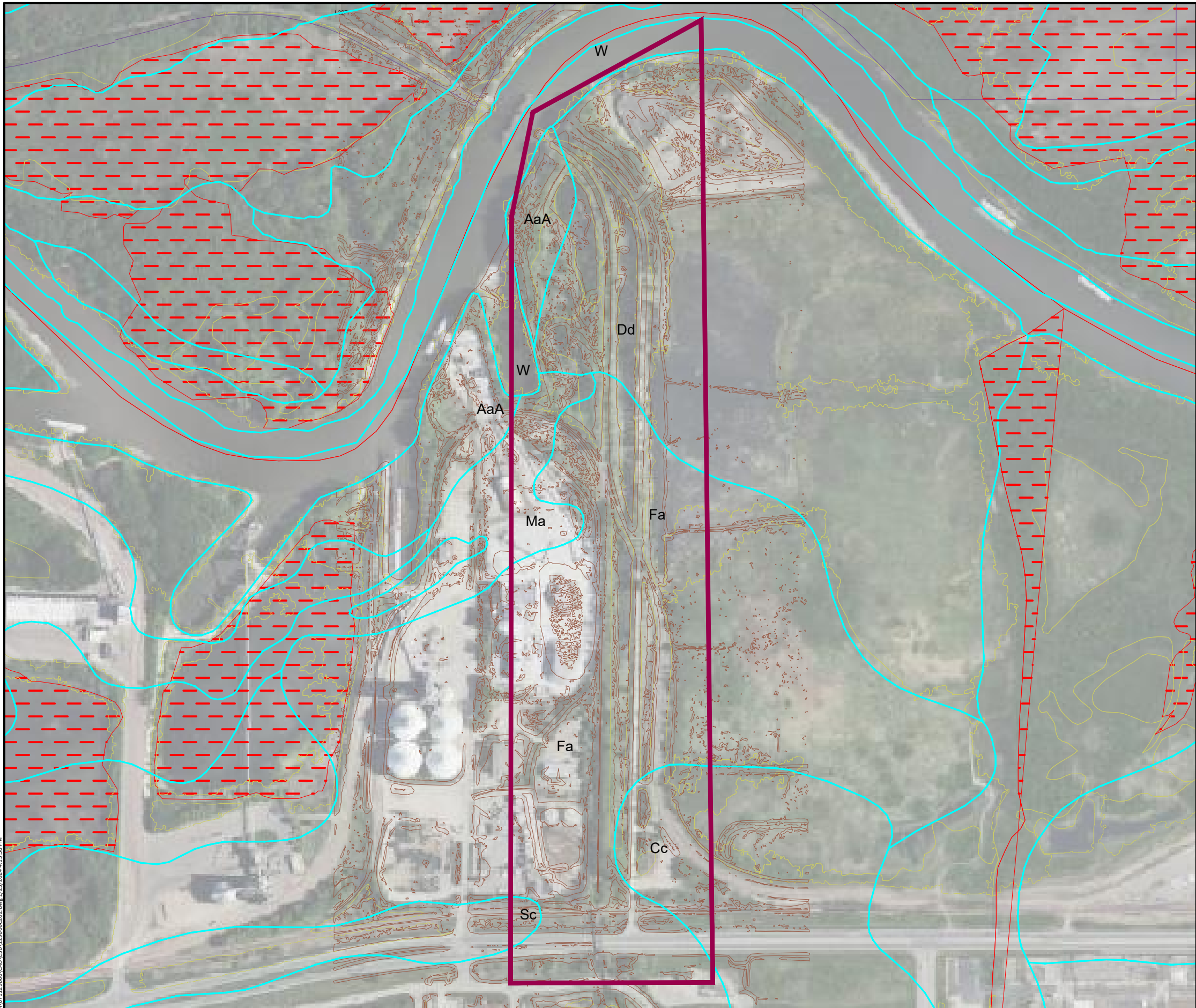

12224 NICOLLET AVENUE  
BURNSVILLE, MINNESOTA 55337  
Phone: (952) 890-0509  
Email: [Burnsville@bolton-menk.com](mailto:Burnsville@bolton-menk.com)  
[www.bolton-menk.com](http://www.bolton-menk.com)

DESIGNED	NO.	ISSUED FOR	DATE
JLW			
DRAWN			
JLW			
CHECKED			
BJF			
CLIENT PROJ. NO.			
01.129866			

LOWER MINNESOTA RIVER WATERSHED DISTRICT  
VERNON AVENUE IMPROVEMENTS  
STORMWATER POLLUTION PREVENTION PLAN  
SWPPP NARRATIVE



**LEGEND**

-  PROJECT BOUNDARY
-  SOIL TYPE
-  IMPAIRED, SPECIAL OR PROTECTED WATERS
-  NATIONAL WETLANDS INVENTORY
-  DWSMA, LOW VULNERABILITY
-  STEEP SLOPES (>33.3%)
-  RECEIVING WATERS



**SOIL TYPE SUMMARY**

Map Unit Symbol	Soil Name	Hyd. Soil Group	Erodibility
MUSYM	MUNAME	HYDGRP	MUHELCL
AaA	Alluvial land, 0-2% slopes	B	NHEL
Ab	Alluvial land, 0-6% slopes	A/D	NHEL
Cc	Comfrey silty clay loam	B/D	NHEL
Dd	Dorchester silty clay loam	C	NHEL
Fa	Faxon silty clay loam, 0-2% slopes	C/D	NHEL
Ma	Marsh	A/D	NHEL
Sc	Stony land		NHEL

NHEL - Not Highly Erodible Land  
 PHEL - Potentially Highly Erodible Land  
 HEL - Highly Erodible Land

**LOCATION OF SWPPP REQUIREMENTS IN PROJECT PLAN**

DESCRIPTION	SHEET NO.
SITE MAP	C2.01
DIRECTION OF FLOW	C2.04 - C2.06
FINAL STABILIZATION	C2.04 - C2.06
SOILS	C2.03
DRAINAGE STRUCTURES	C5.01
DRAINAGE TABULATION	G1.01
STORM SEWER PLAN & PROFILE SHEETS	C5.01
EROSION & SEDIMENT CONTROL DETAILS	C1.02 - C1.03
EROSION CONTROL TABULATION	C2.01
TURF ESTABLISHMENT TABULATION	C2.01
NARRATIVE & NOTES	C2.01 - C2.02

© Bolton & Menk, Inc. 2023. All Rights Reserved. P:\LOWMINN\_RIVER\1229866\CADD\1229866\C2.03.dwg 1/25/2024 4:15:38 PM

I HEREBY CERTIFY THAT THIS PLAN, SPECIFICATION, OR REPORT WAS PREPARED BY ME OR UNDER MY DIRECT SUPERVISION AND THAT I AM A DULY LICENSED PROFESSIONAL ENGINEER UNDER THE LAWS OF THE STATE OF MINNESOTA.

*Bradley J Fisher*  
 BRADLEY J FISHER  
 LIC. NO. 56595 DATE 02/21/2024



12224 NICOLLET AVENUE  
 BURNSVILLE, MINNESOTA 55337  
 Phone: (952) 890-0509  
 Email: Burnsville@bolton-menk.com  
 www.bolton-menk.com

DESIGNED	NO.	ISSUED FOR	DATE
JLW			
JLW			
BJF			
CLIENT PROJ. NO.	0T1.129866		

LOWER MINNESOTA RIVER WATERSHED DISTRICT  
 VERNON AVENUE IMPROVEMENTS  
 STORMWATER POLLUTION PREVENTION PLAN  
 SWPPP SOILS

SHEET  
**C2.03**

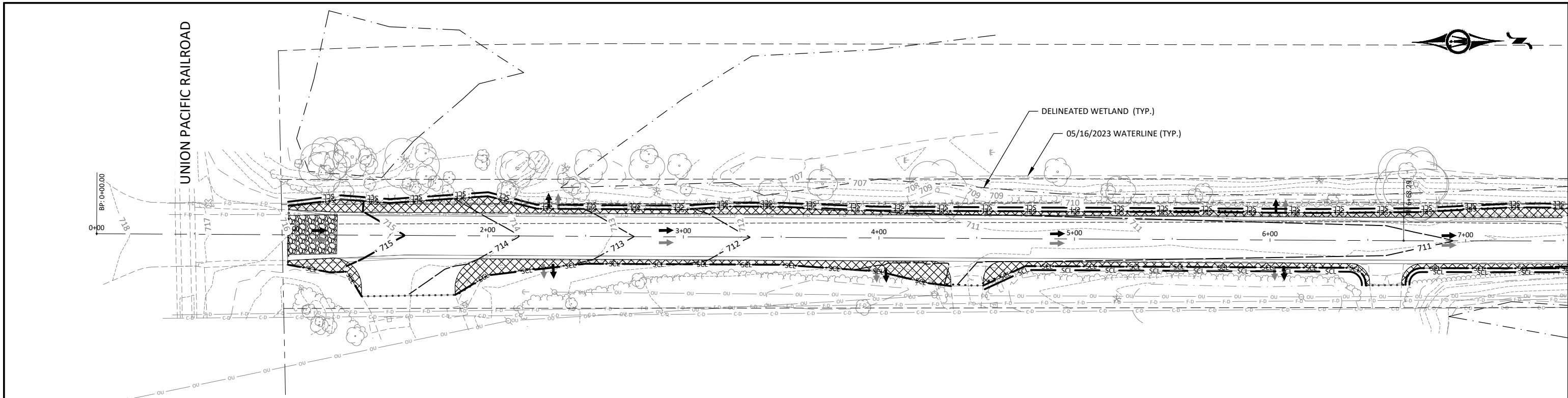

EROSION CONTROL LEGEND			
.....	CONSTRUCTION LIMITS		STABILIZED CONSTRUCTION EXIT
→ →	EXISTING/PROPOSED DRAINAGE FLOW		SEED & BLANKET (SEED MIX 25-141)
	TURBIDITY BARRIER		SEED & BLANKET (SEED MIX 34-181)
	SEDIMENT CONTROL LOG		
	INLET PROTECTION		

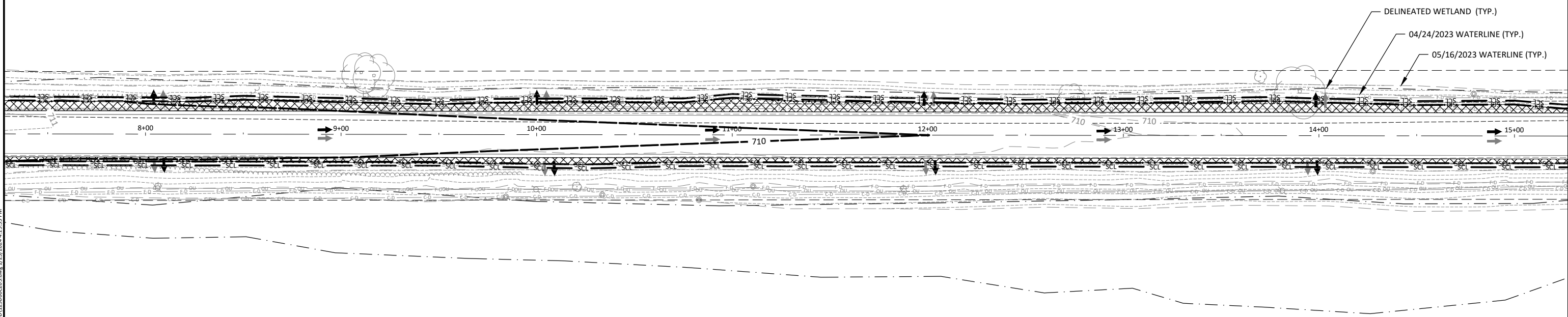

© Bolton & Menk, Inc. 2023. All Rights Reserved. PLLOWMINN011138651CAD (CADD)129866C203.dwg 1/25/2024 4:15:55 PM

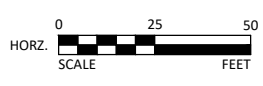

I HEREBY CERTIFY THAT THIS PLAN, SPECIFICATION, OR REPORT WAS PREPARED BY ME OR UNDER MY DIRECT SUPERVISION AND THAT I AM A DULY LICENSED PROFESSIONAL ENGINEER UNDER THE LAWS OF THE STATE OF MINNESOTA.

*Bradley J Fisher*  
 BRADLEY J FISHER  
 LIC. NO. 56595 DATE 02/21/2024



12224 NICOLLET AVENUE  
 BURNSVILLE, MINNESOTA 55337  
 Phone: (952) 890-0509  
 Email: Burnsville@bolton-menk.com  
 www.bolton-menk.com

DESIGNED	NO.	ISSUED FOR	DATE
JLW			
DRAWN			
JLW			
CHECKED			
BJF			
CLIENT PROJ. NO.			
011.129866			

LOWER MINNESOTA RIVER WATERSHED DISTRICT  
 VERNON AVENUE IMPROVEMENTS  
 EROSION CONTROL PLAN

SHEET  
 C2.04



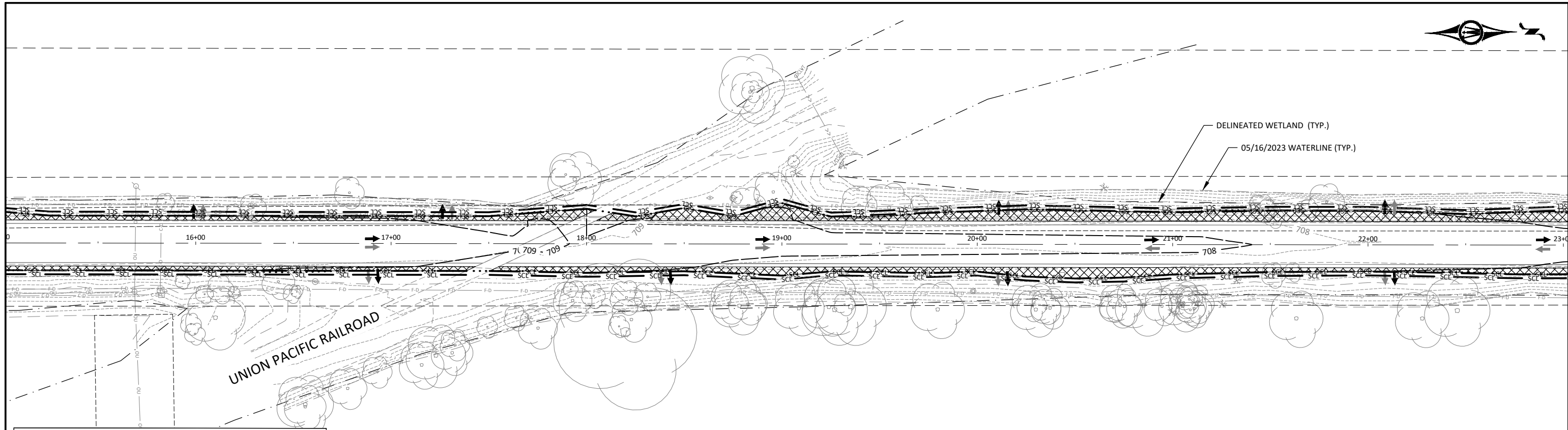

EROSION CONTROL LEGEND	
.....	CONSTRUCTION LIMITS
→ →	EXISTING/PROPOSED DRAINAGE FLOW
— — —	TURBIDITY BARRIER
—SCL—	SEDIMENT CONTROL LOG
⊙	INLET PROTECTION
	STABILIZED CONSTRUCTION EXIT
	SEED & BLANKET (SEED MIX 25-141)
	SEED & BLANKET (SEED MIX 34-181)

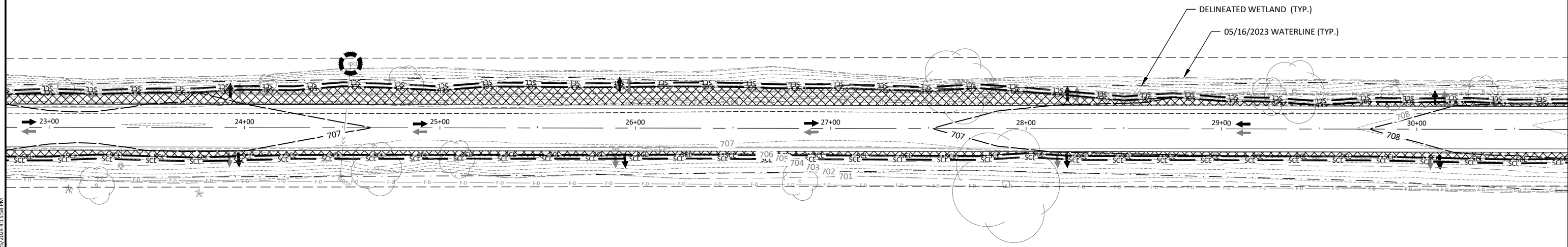

© Bolton & Menk, Inc. 2023. All Rights Reserved. PLANNING AND DESIGN SERVICES CONTRACT NO. 2023-001123865 (CAD) 1/25/2024 4:15:58 PM

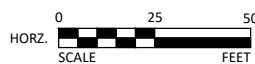

I HEREBY CERTIFY THAT THIS PLAN, SPECIFICATION, OR REPORT WAS PREPARED BY ME OR UNDER MY DIRECT SUPERVISION AND THAT I AM A DULY LICENSED PROFESSIONAL ENGINEER UNDER THE LAWS OF THE STATE OF MINNESOTA.

*Bradley J Fisher*  
 BRADLEY J FISHER  
 LIC. NO. 56595 DATE 02/21/2024



12224 NICOLLET AVENUE  
 BURNSVILLE, MINNESOTA 55337  
 Phone: (952) 890-0509  
 Email: Burnsville@bolton-menk.com  
 www.bolton-menk.com

DESIGNED	NO.	ISSUED FOR	DATE
JLW			
DRAWN			
JLW			
CHECKED			
BJF			
CLIENT PROJ. NO.			
0T1.129866			

LOWER MINNESOTA RIVER WATERSHED DISTRICT  
 VERNON AVENUE IMPROVEMENTS  
 EROSION CONTROL PLAN

SHEET  
 C2.05

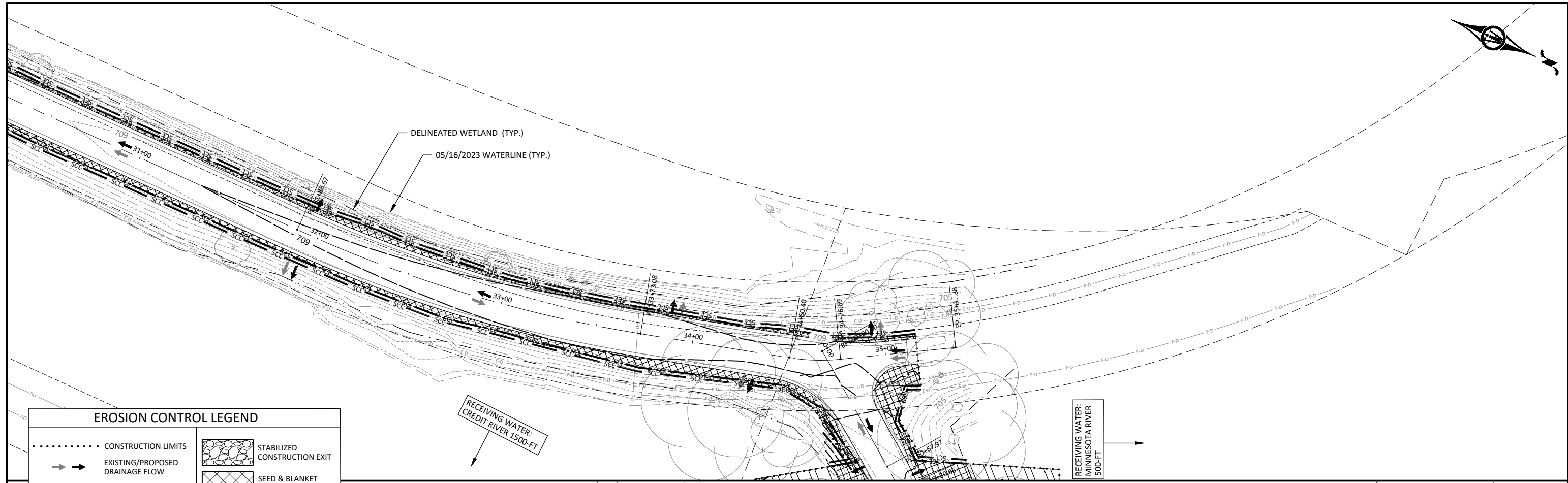
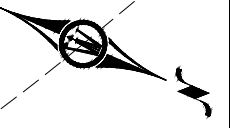

EROSION CONTROL LEGEND	
.....	CONSTRUCTION LIMITS
→ →	EXISTING/PROPOSED DRAINAGE FLOW
— — —	TURBIDITY BARRIER
—SCL—	SEDIMENT CONTROL LOG
⊙	INLET PROTECTION
	STABILIZED CONSTRUCTION EXIT
	SEED & BLANKET (SEED MIX 25-141)
	SEED & BLANKET (SEED MIX 34-181)

RECEIVING WATER:  
CREDIT RIVER  
1500-FT

RECEIVING WATER:  
MINNESOTA RIVER  
500-FT

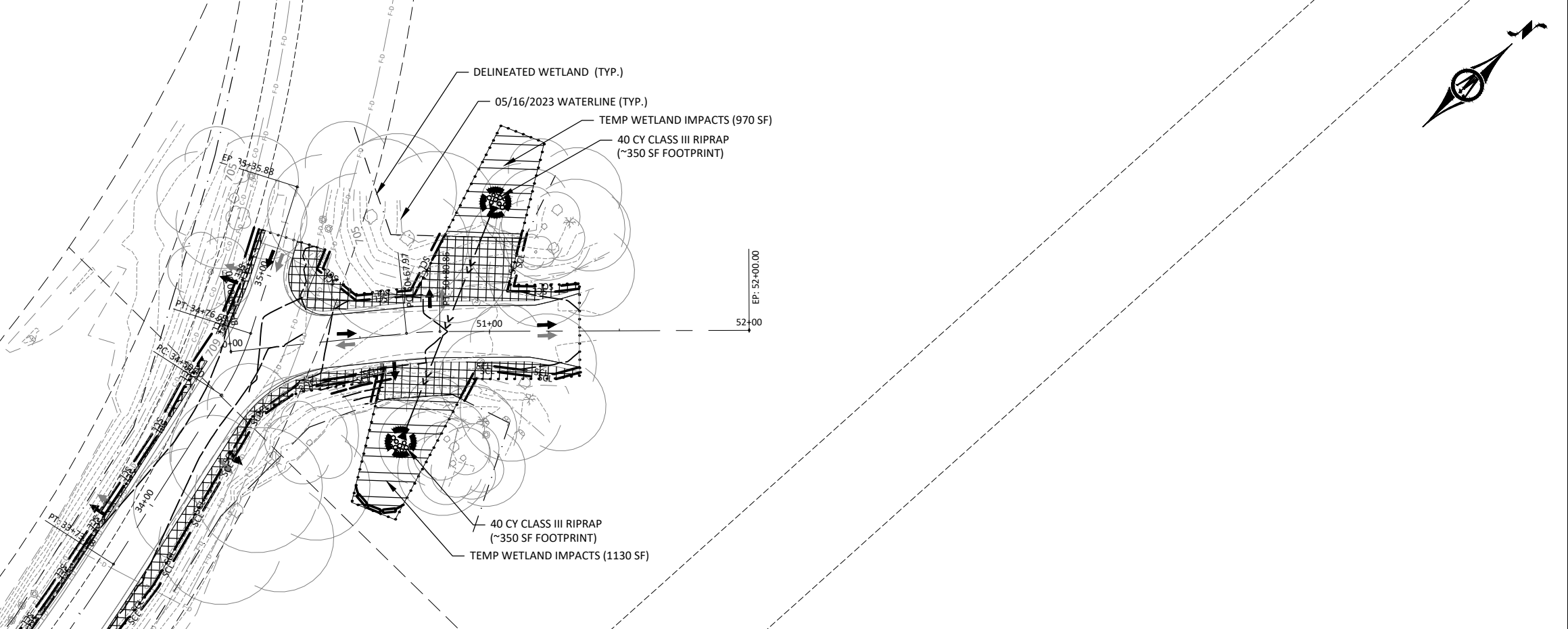

© Bolton & Menk, Inc. 2023. All Rights Reserved. PL:\MINN\1129866\CD\129866CD3.dwg 1/25/2024 4:16:00 PM

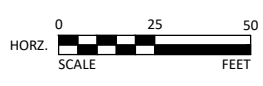

I HEREBY CERTIFY THAT THIS PLAN, SPECIFICATION, OR REPORT WAS PREPARED BY ME OR UNDER MY DIRECT SUPERVISION AND THAT I AM A DULY LICENSED PROFESSIONAL ENGINEER UNDER THE LAWS OF THE STATE OF MINNESOTA.

*Bradley J Fisher*  
BRADLEY J FISHER  
LIC. NO. 56595 DATE 02/21/2024



12224 NICOLLET AVENUE  
BURNSVILLE, MINNESOTA 55337  
Phone: (952) 890-0509  
Email: Burnsville@bolton-menk.com  
www.bolton-menk.com

DESIGNED	NO.	ISSUED FOR	DATE
JLW			
DRAWN			
JLW			
CHECKED			
BJF			
CLIENT PROJ. NO.			
0T1.129866			

LOWER MINNESOTA RIVER WATERSHED DISTRICT  
VERNON AVENUE IMPROVEMENTS  
EROSION CONTROL PLAN

SHEET  
C2.06

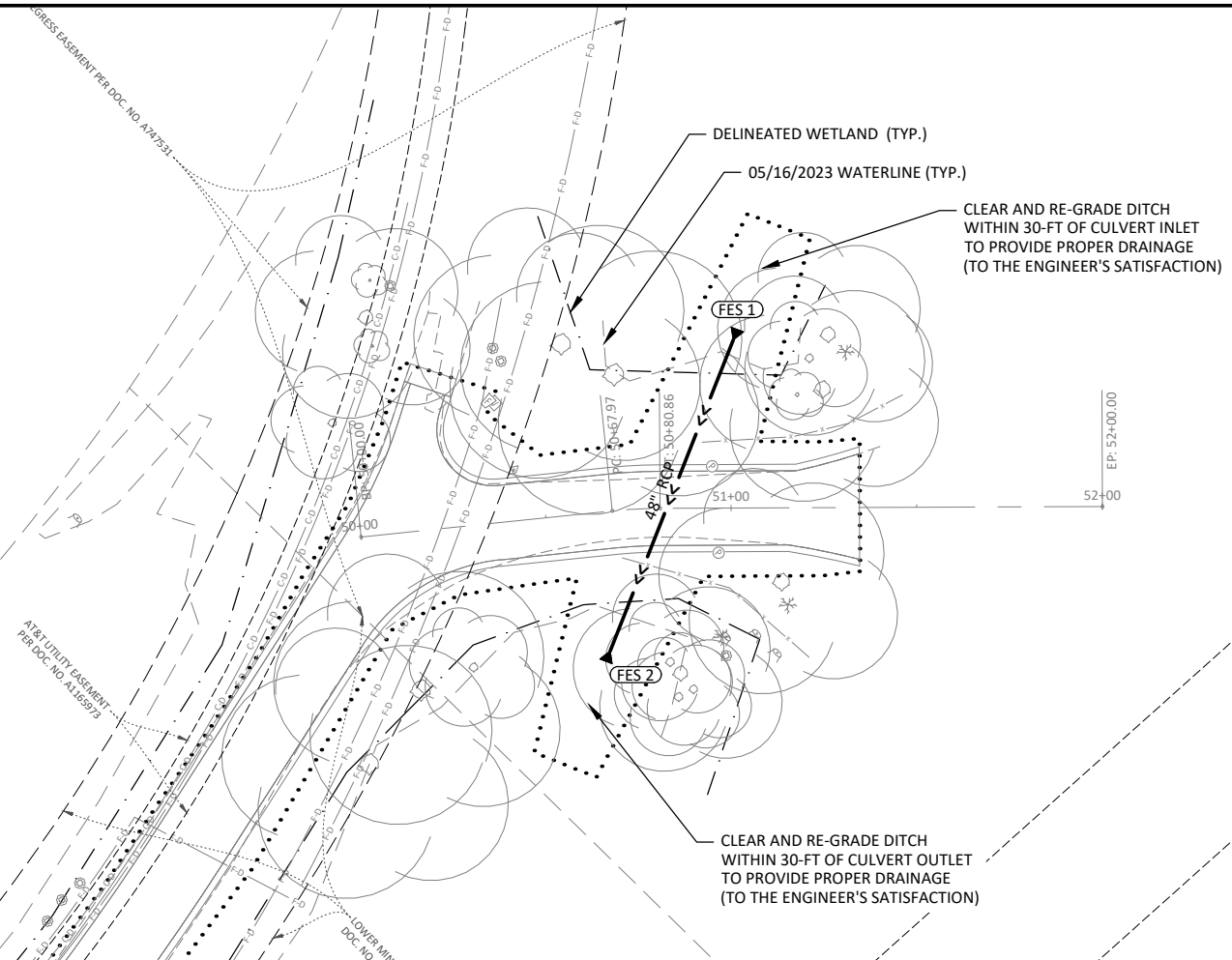
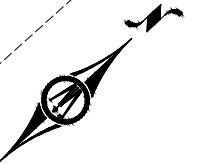

- DEWATERING PLAN:**
1. CONTRACTOR TO CONSTRUCT COFFERDAMS ON BOTH ENDS OF THE CULVERT, AS NECESSARY TO DEWATER THE CULVERT WORK AREA SUFFICIENTLY TO CONSTRUCT THE IMPROVEMENTS AS REQUIRED (OR APPROVED ALTERNATIVE METHOD).
  2. THE CONTRACTOR SHALL SUBMIT A PROPOSED DEWATERING PLAN, AND THE METHODS TO BE USED, TO THE ENGINEER FOR REVIEW AND APPROVAL PRIOR TO COMMENCING THE WORK. THE PROPOSED DEWATERING PLAN SHALL BE IN COMPLIANCE WITH SECTION 10 OF THE NPDES/SDS PERMIT MNR100001.

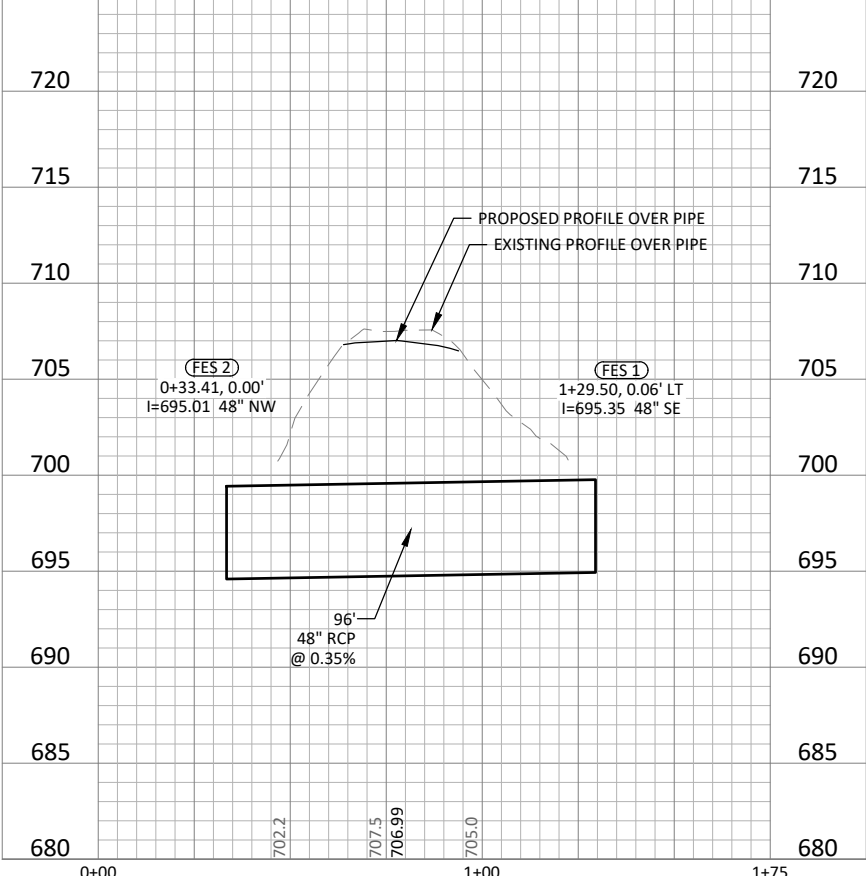

© Bolton & Menk, Inc. 2023. All Rights Reserved. PLLOWATERING.MXD - 11/13/2024 12:28:56 PM 1/25/2024 4:16:13 PM

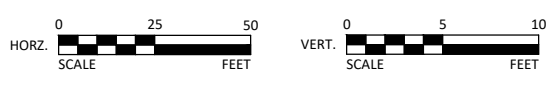

I HEREBY CERTIFY THAT THIS PLAN, SPECIFICATION, OR REPORT WAS PREPARED BY ME OR UNDER MY DIRECT SUPERVISION AND THAT I AM A DULY LICENSED PROFESSIONAL ENGINEER UNDER THE LAWS OF THE STATE OF MINNESOTA.

*Bradley J Fisher*  
 BRADLEY J FISHER  
 LIC. NO. 56595 DATE 02/21/2024



12224 NICOLLET AVENUE  
 BURNSVILLE, MINNESOTA 55337  
 Phone: (952) 890-0509  
 Email: Burnsville@bolton-menk.com  
 www.bolton-menk.com

DESIGNED	NO.	ISSUED FOR	DATE
JLW			
DRAWN			
JLW			
CHECKED			
BJF			
CLIENT PROJ. NO.			
011.129866			

LOWER MINNESOTA RIVER WATERSHED DISTRICT  
 VERNON AVENUE IMPROVEMENTS  
 STORM SEWER PLAN AND PROFILE

SHEET  
**C5.01**



MATCH EXISTING BITUMINOUS PAVEMENT

DELINEATED WETLAND (TYP.)

05/16/2023 WATERLINE (TYP.)

BP: 0+00.00  
0+00

UNION PACIFIC RAILROAD

MATCH EXISTING

LOWER MINNESOTA RIVER WATERSHED DISTRICT PIPELINE EASEMENT PER DOC. NO. A747533/T178586 & ACCESS EASEMENT PER DOC. NO. A747534

MATCH EXISTING

MATCH EXISTING

**LEGEND**

- BITUMINOUS PAVEMENT
- AGGREGATE SURFACING
- CONSTRUCTION LIMITS

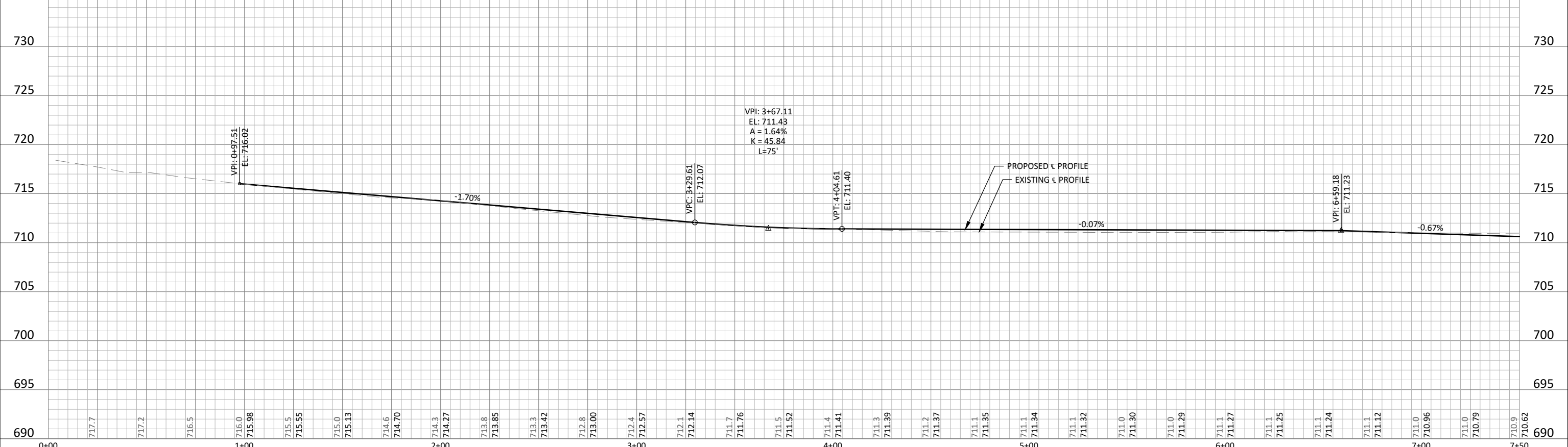

© Bolton & Menk, Inc. 2023. All Rights Reserved. P:\LOWMINRIVER\MINN\_VD\11071123865\CAD\C6.01\29856501.dwg 1/25/2024 4:16:41 PM

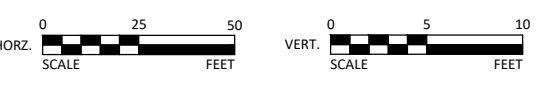

I HEREBY CERTIFY THAT THIS PLAN, SPECIFICATION, OR REPORT WAS PREPARED BY ME OR UNDER MY DIRECT SUPERVISION AND THAT I AM A DULY LICENSED PROFESSIONAL ENGINEER UNDER THE LAWS OF THE STATE OF MINNESOTA.

*Bradley J Fisher*  
BRADLEY J FISHER  
LIC. NO. 56595 DATE 02/21/2024



12224 NICOLLET AVENUE  
BURNSVILLE, MINNESOTA 55337  
Phone: (952) 890-0509  
Email: Burnsville@bolton-menk.com  
www.bolton-menk.com

DESIGNED	NO.	ISSUED FOR	DATE
JLW			
DRAWN			
JLW			
CHECKED			
BJF			
CLIENT PROJ. NO.			
011.129866			

LOWER MINNESOTA RIVER WATERSHED DISTRICT  
VERNON AVENUE IMPROVEMENTS  
STREET PLAN & PROFILE

SHEET  
**C6.01**

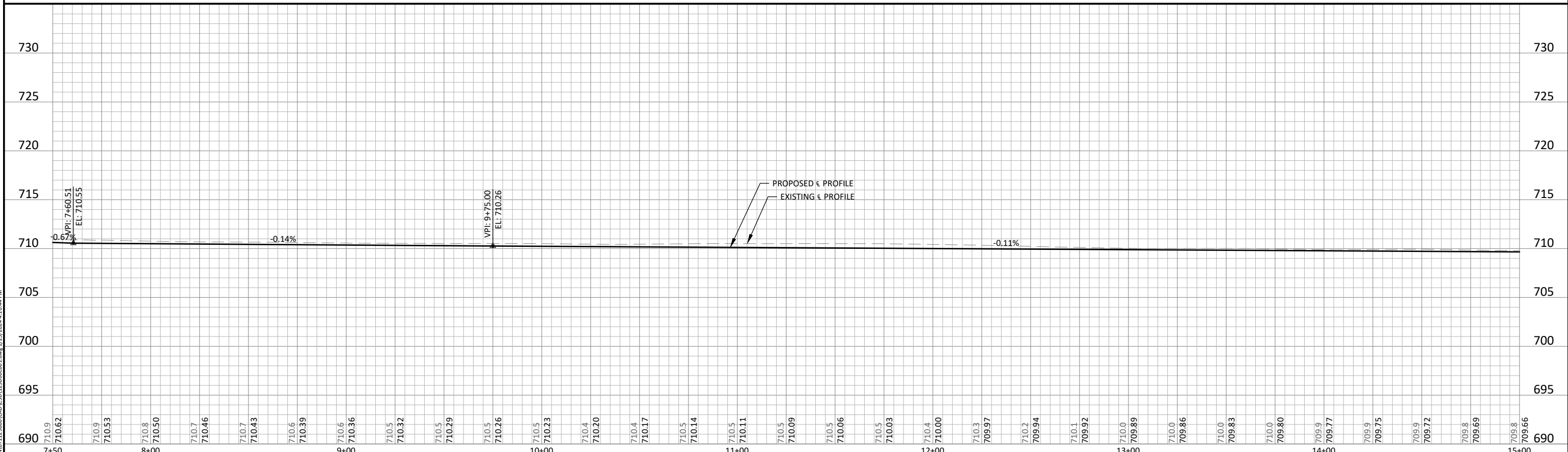
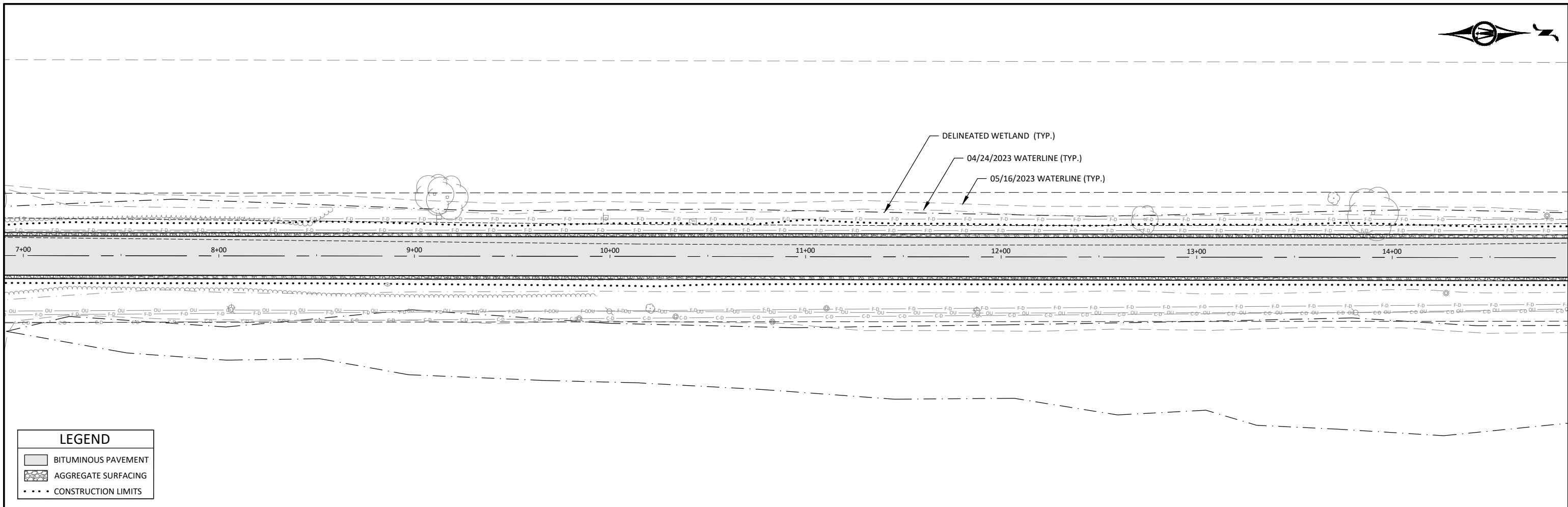

© Bolton & Menk, Inc. 2023. All Rights Reserved. PLANNING.DWG 1/25/2024 4:16:44 PM

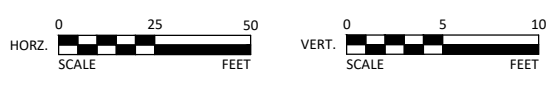

I HEREBY CERTIFY THAT THIS PLAN, SPECIFICATION, OR REPORT WAS PREPARED BY ME OR UNDER MY DIRECT SUPERVISION AND THAT I AM A DULY LICENSED PROFESSIONAL ENGINEER UNDER THE LAWS OF THE STATE OF MINNESOTA.

*Bradley J Fisher*  
 BRADLEY J FISHER  
 LIC. NO. 56595 DATE 02/21/2024



12224 NICOLLET AVENUE  
 BURNSVILLE, MINNESOTA 55337  
 Phone: (952) 890-0509  
 Email: Burnsville@bolton-menk.com  
 www.bolton-menk.com

DESIGNED	NO.	ISSUED FOR	DATE
JLW			
DRAWN			
JLW			
CHECKED			
BJF			
CLIENT PROJ. NO.			
01.129866			

LOWER MINNESOTA RIVER WATERSHED DISTRICT  
 VERNON AVENUE IMPROVEMENTS  
 STREET PLAN & PROFILE

SHEET  
**C6.02**

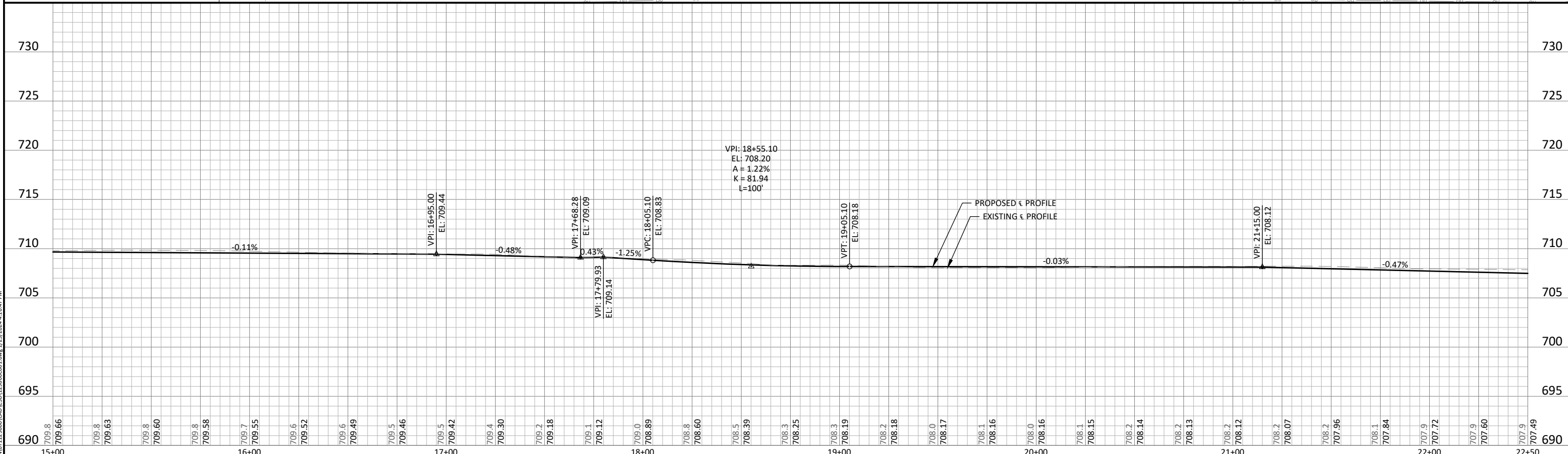
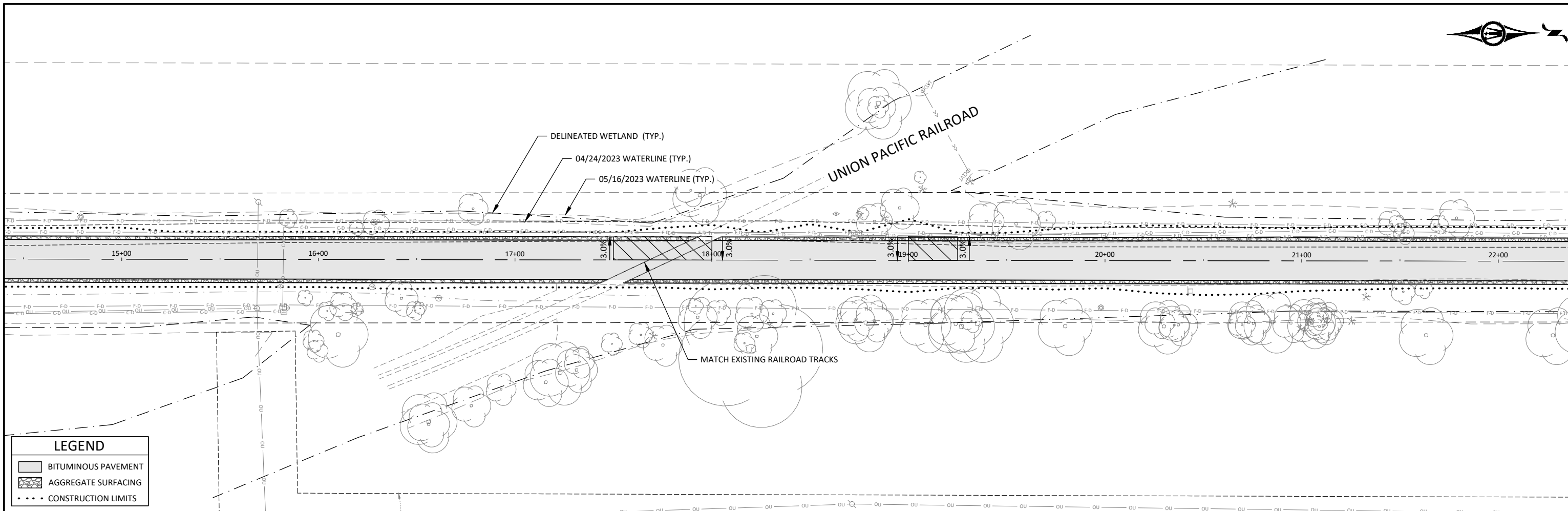

© Bolton & Menk, Inc. 2023. All Rights Reserved. ALLOWAYMINN\_VD\_MIN01129866\_CAD\_CDD129866CDD1.dwg 1/25/2024 4:16:47 PM

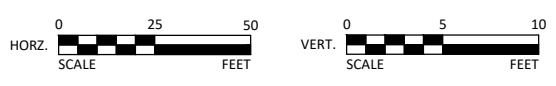

I HEREBY CERTIFY THAT THIS PLAN, SPECIFICATION, OR REPORT WAS PREPARED BY ME OR UNDER MY DIRECT SUPERVISION AND THAT I AM A DULY LICENSED PROFESSIONAL ENGINEER UNDER THE LAWS OF THE STATE OF MINNESOTA.

*Bradley J Fisher*  
 BRADLEY J FISHER  
 LIC. NO. 56595 DATE 02/21/2024



12224 NICOLLET AVENUE  
 BURNSVILLE, MINNESOTA 55337  
 Phone: (952) 890-0509  
 Email: Burnsville@bolton-menk.com  
 www.bolton-menk.com

DESIGNED	NO.	ISSUED FOR	DATE
JLW			
DRAWN			
JLW			
CHECKED			
BJF			
CLIENT PROJ. NO.			
011.129866			

LOWER MINNESOTA RIVER WATERSHED DISTRICT  
 VERNON AVENUE IMPROVEMENTS  
 STREET PLAN & PROFILE

SHEET  
**C6.03**

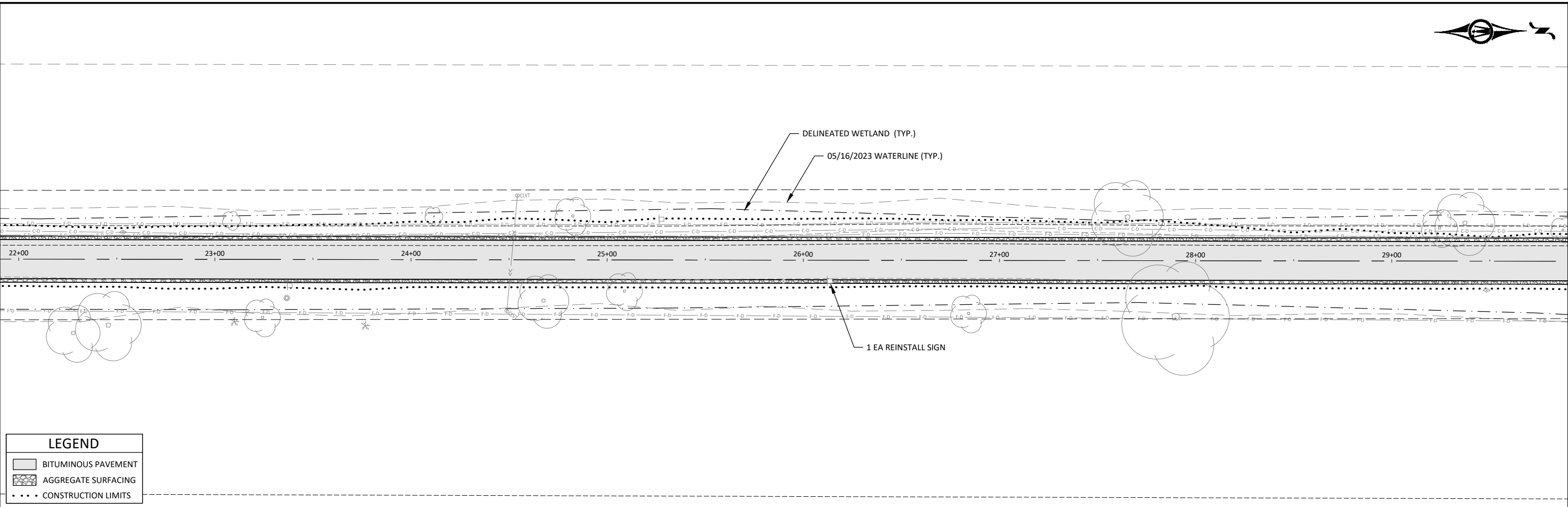

LEGEND	
	BITUMINOUS PAVEMENT
	AGGREGATE SURFACING
	CONSTRUCTION LIMITS

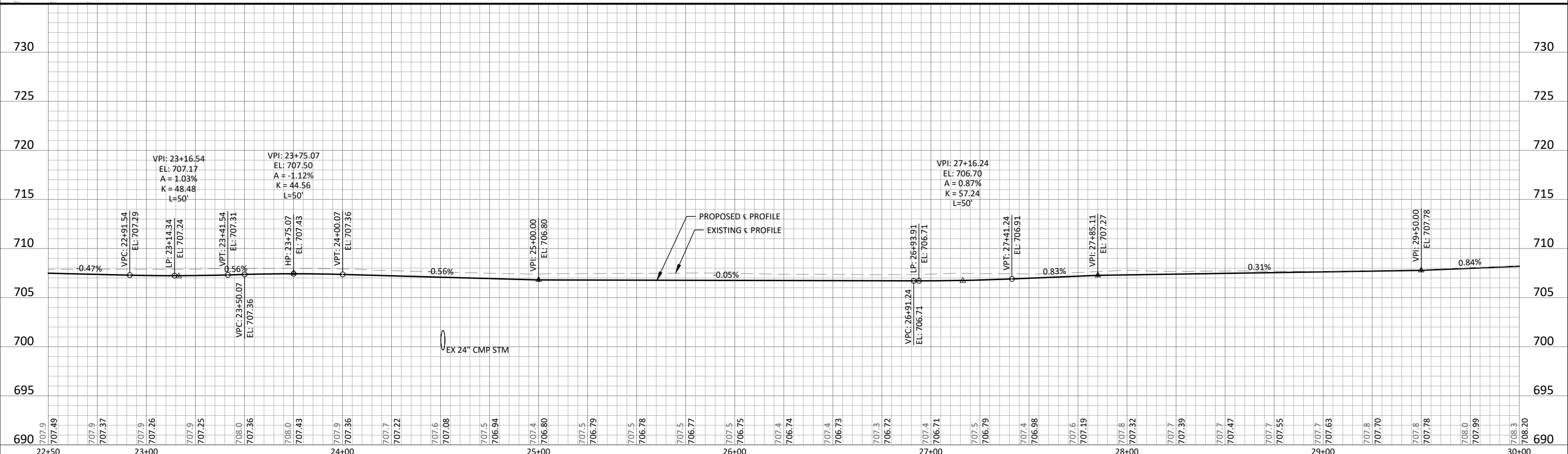

© Bolton & Menk, Inc. 2023. All Rights Reserved. PL:\D\1129866\CD\129866.dwg 1/25/2024 4:16:50 PM



I HEREBY CERTIFY THAT THIS PLAN, SPECIFICATION, OR REPORT WAS PREPARED BY ME OR UNDER MY DIRECT SUPERVISION AND THAT I AM A DULY LICENSED PROFESSIONAL ENGINEER UNDER THE LAWS OF THE STATE OF MINNESOTA.

*Bradley J Fisher*  
 BRADLEY J FISHER  
 LIC. NO. 56595 DATE 02/21/2024



12224 NICOLLET AVENUE  
 BURNSVILLE, MINNESOTA 55337  
 Phone: (952) 890-0509  
 Email: Burnsville@bolton-menk.com  
 www.bolton-menk.com

DESIGNED	NO.	ISSUED FOR	DATE
JLW			
DRAWN			
JLW			
CHECKED			
BJF			
CLIENT PROJ. NO.	011.129866		

LOWER MINNESOTA RIVER WATERSHED DISTRICT  
 VERNON AVENUE IMPROVEMENTS  
 STREET PLAN & PROFILE

SHEET  
**C6.04**

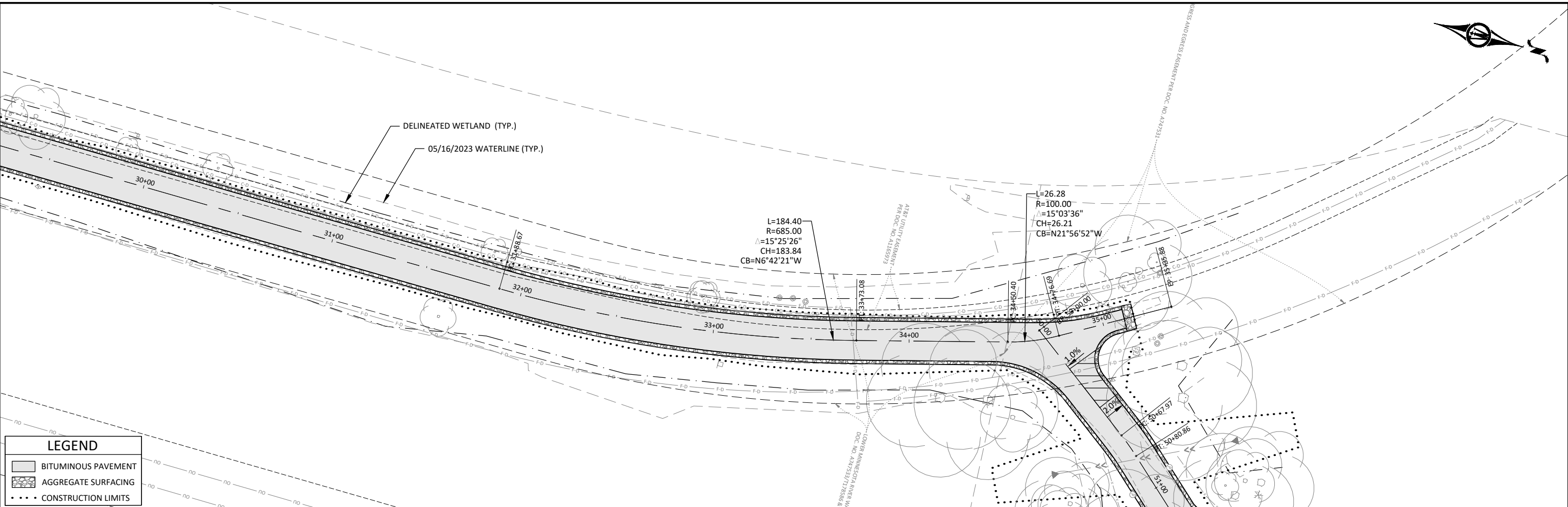

**LEGEND**

- BITUMINOUS PAVEMENT
- AGGREGATE SURFACING
- CONSTRUCTION LIMITS

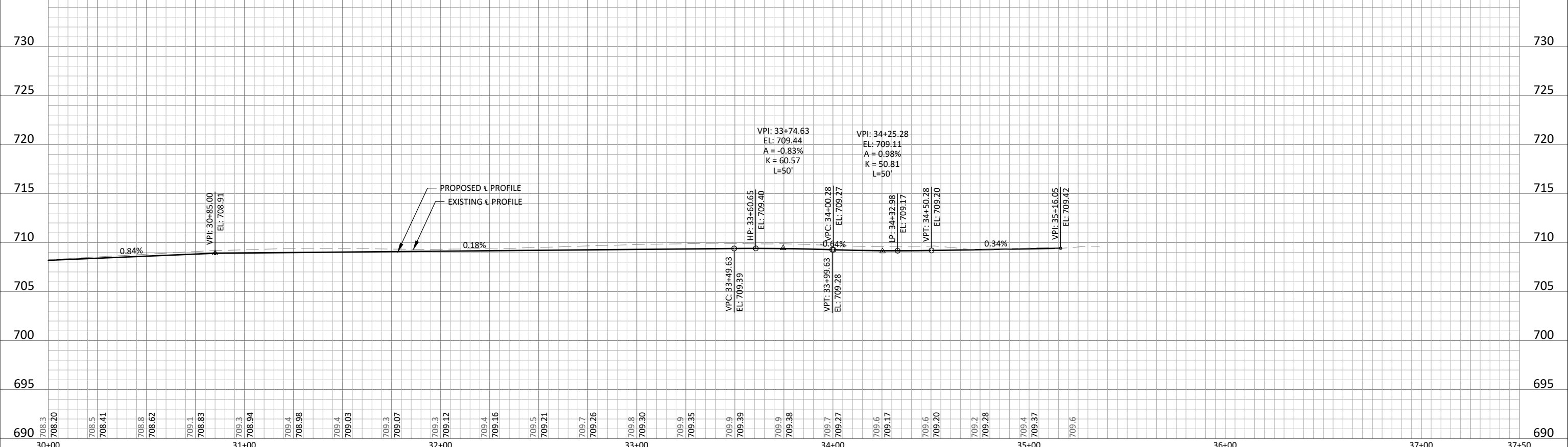

© Bolton & Menk, Inc. 2023. All Rights Reserved. PL00000001.DWG 1/25/2024 4:16:52 PM

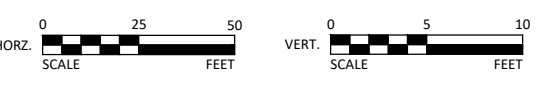

I HEREBY CERTIFY THAT THIS PLAN, SPECIFICATION, OR REPORT WAS PREPARED BY ME OR UNDER MY DIRECT SUPERVISION AND THAT I AM A DULY LICENSED PROFESSIONAL ENGINEER UNDER THE LAWS OF THE STATE OF MINNESOTA.

*Bradley J Fisher*  
 BRADLEY J FISHER  
 LIC. NO. 56595 DATE 02/21/2024



12224 NICOLLET AVENUE  
 BURNSVILLE, MINNESOTA 55337  
 Phone: (952) 890-0509  
 Email: Burnsville@bolton-menk.com  
 www.bolton-menk.com

DESIGNED	NO.	ISSUED FOR	DATE
JLW			
DRAWN			
JLW			
CHECKED			
BJF			
CLIENT PROJ. NO.	0T1.129866		

LOWER MINNESOTA RIVER WATERSHED DISTRICT  
 VERNON AVENUE IMPROVEMENTS  
 STREET PLAN & PROFILE

SHEET  
**C6.05**



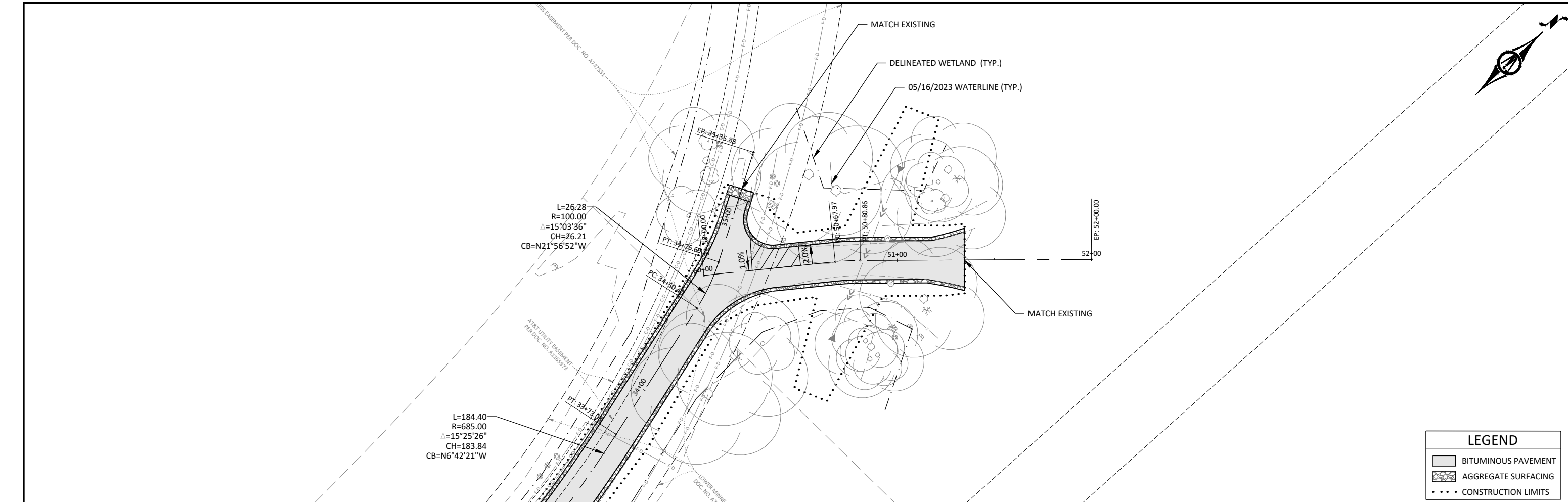

LEGEND	
	BITUMINOUS PAVEMENT
	AGGREGATE SURFACING
	CONSTRUCTION LIMITS

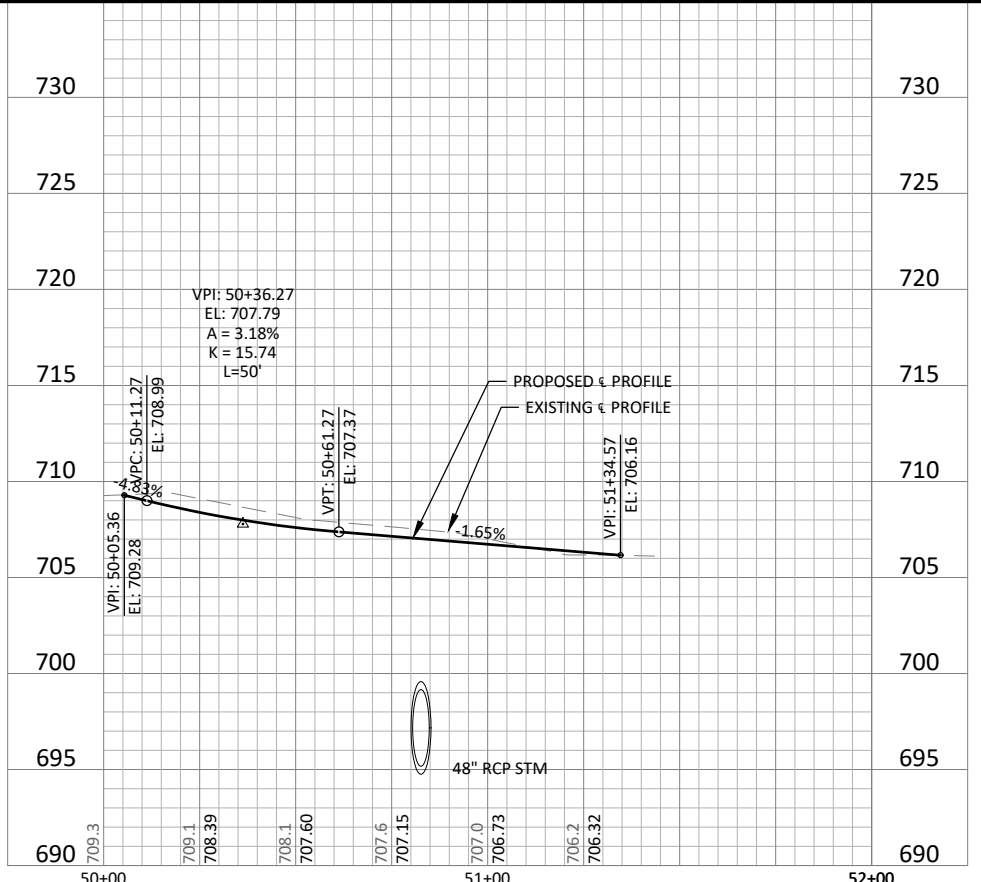

© Bolton & Menk, Inc. 2023. All Rights Reserved  
 PLU04711136851.dwg 1/25/2024 4:16:55 PM

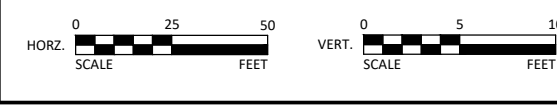

I HEREBY CERTIFY THAT THIS PLAN, SPECIFICATION, OR REPORT WAS PREPARED BY ME OR UNDER MY DIRECT SUPERVISION AND THAT I AM A DULY LICENSED PROFESSIONAL ENGINEER UNDER THE LAWS OF THE STATE OF MINNESOTA.  
*Bradley J Fisher*  
 BRADLEY J FISHER  
 LIC. NO. 56595 DATE 02/21/2024



12224 NICOLLET AVENUE  
 BURNSVILLE, MINNESOTA 55337  
 Phone: (952) 890-0509  
 Email: Burnsville@bolton-menk.com  
 www.bolton-menk.com

DESIGNED	NO.	ISSUED FOR	DATE
JLW			
DRAWN			
JLW			
CHECKED			
BJF			
CLIENT PROJ. NO.	011.129866		

LOWER MINNESOTA RIVER WATERSHED DISTRICT		SHEET <b>C6.06</b>
VERNON AVENUE IMPROVEMENTS		
STREET PLAN & PROFILE		

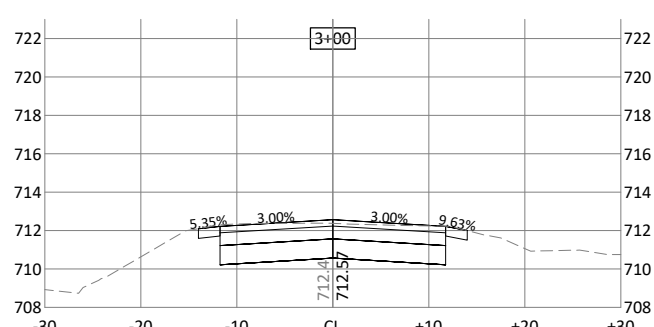
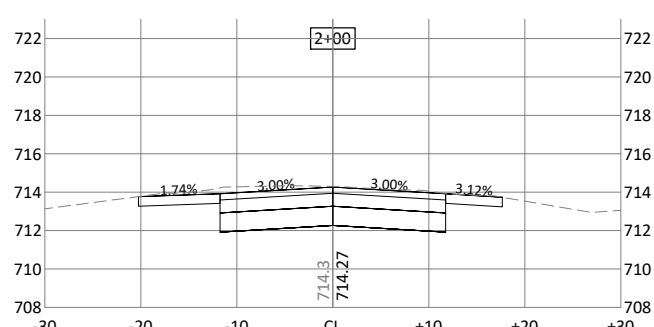
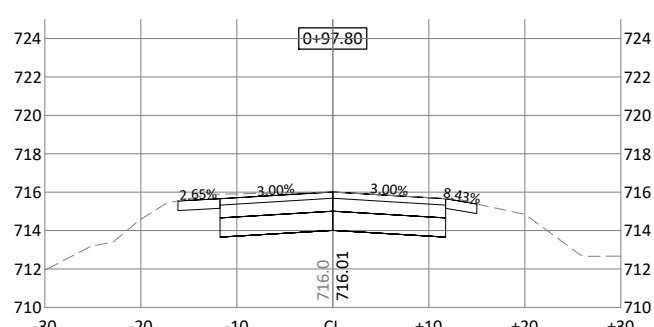
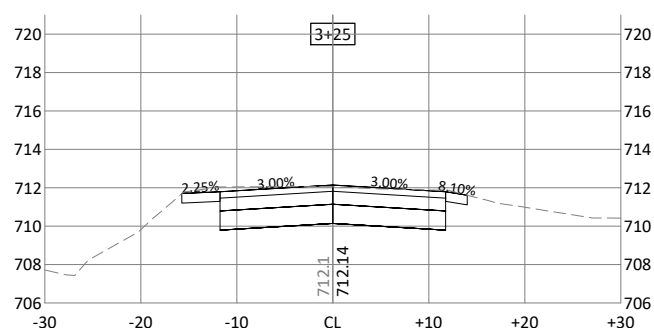
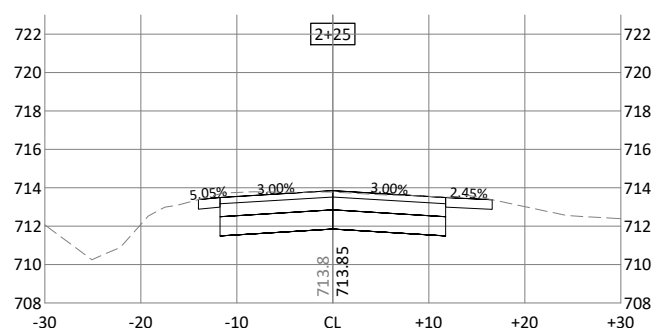
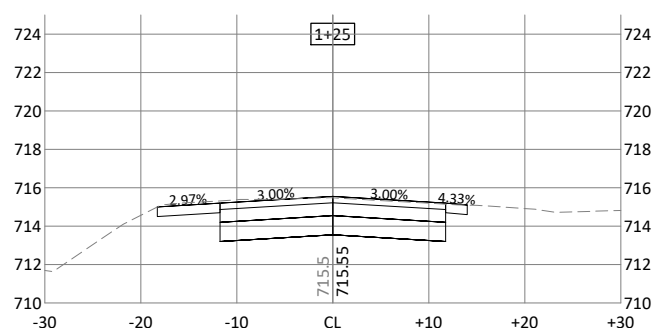
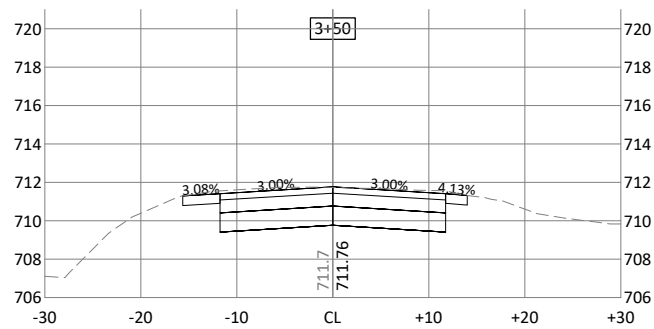
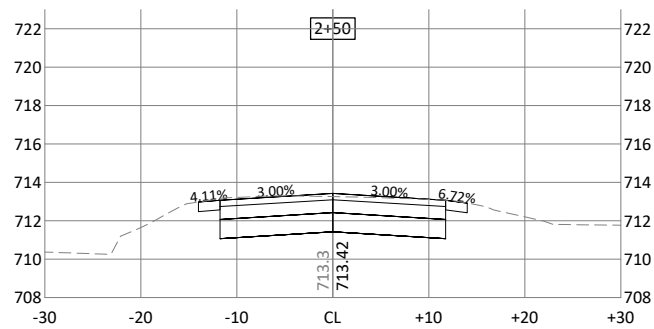
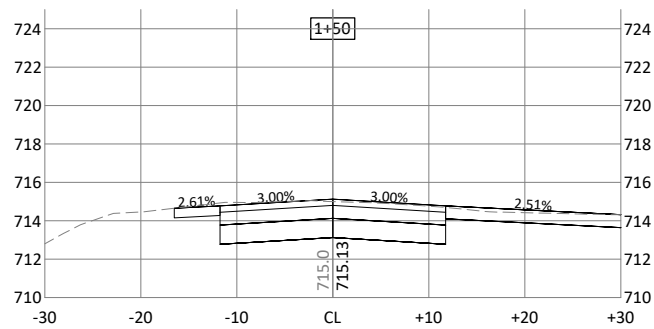
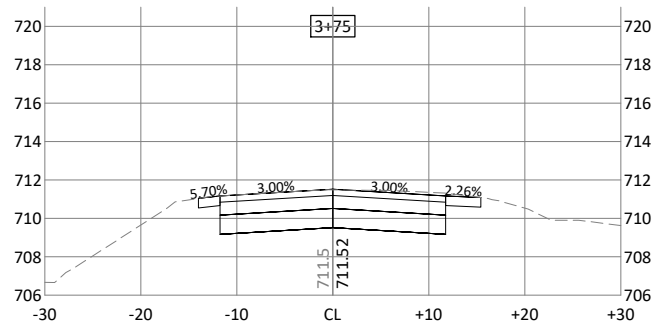
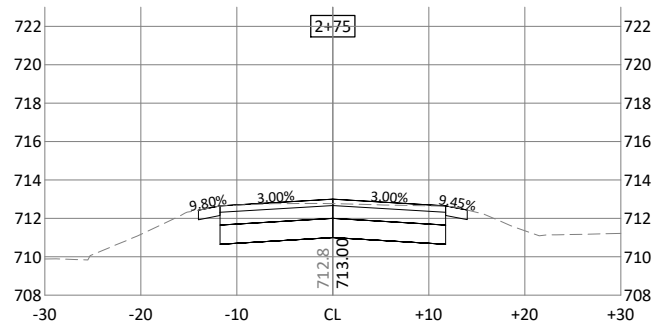
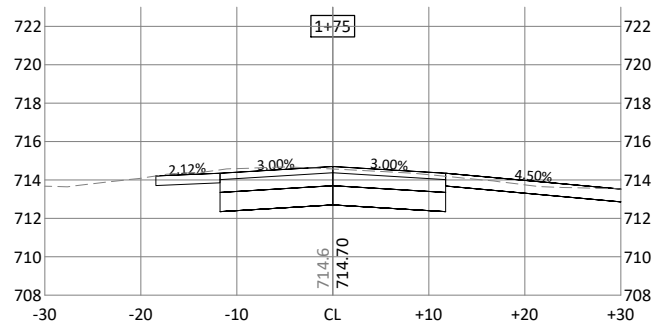

© Bolton & Menk, Inc. 2023. All Rights Reserved. 11/29/2023 11:38:51 AM C:\D:\129866\01.dwg 1/25/2024 4:17:07 PM

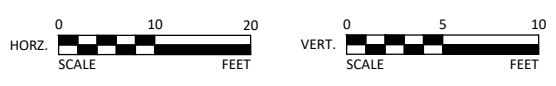

I HEREBY CERTIFY THAT THIS PLAN, SPECIFICATION, OR REPORT WAS PREPARED BY ME OR UNDER MY DIRECT SUPERVISION AND THAT I AM A DULY LICENSED PROFESSIONAL ENGINEER UNDER THE LAWS OF THE STATE OF MINNESOTA.

*Bradley J Fisher*  
 BRADLEY J FISHER  
 LIC. NO. 56595 DATE 02/21/2024



12224 NICOLLET AVENUE  
 BURNSVILLE, MINNESOTA 55337  
 Phone: (952) 890-0509  
 Email: Burnsville@bolton-menk.com  
 www.bolton-menk.com

DESIGNED	NO.	ISSUED FOR	DATE
JLW			
DRAWN			
JLW			
CHECKED			
BJF			
CLIENT PROJ. NO.			
011.129866			

LOWER MINNESOTA RIVER WATERSHED DISTRICT  
 VERNON AVENUE IMPROVEMENTS  
 CROSS SECTIONS  
 VERNON AVE N

SHEET  
**C8.01**

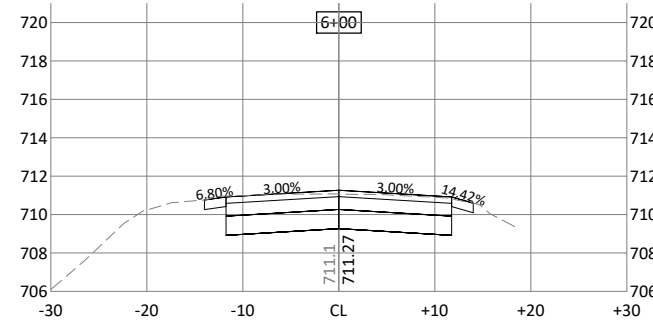
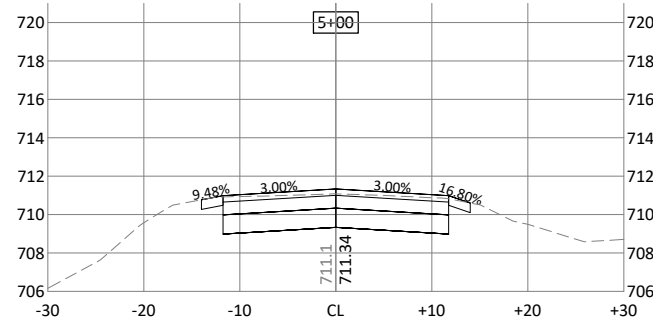
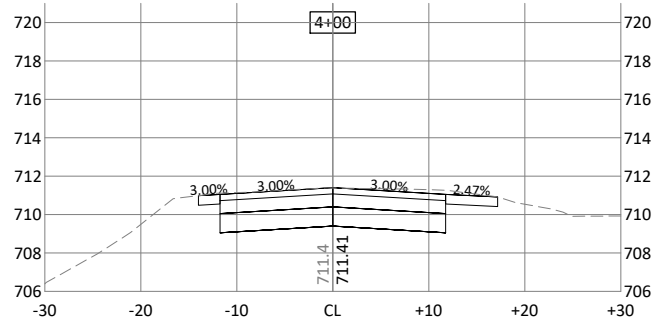
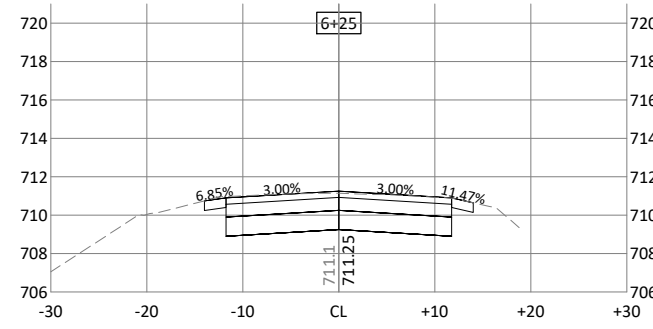
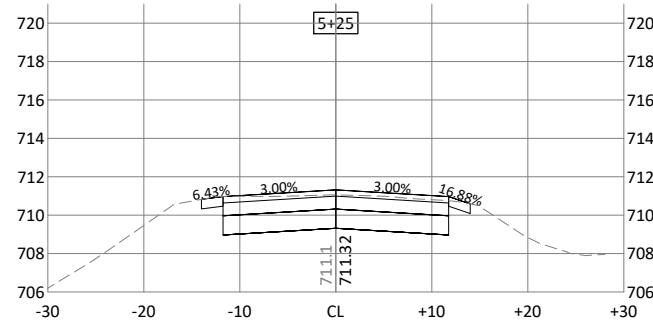
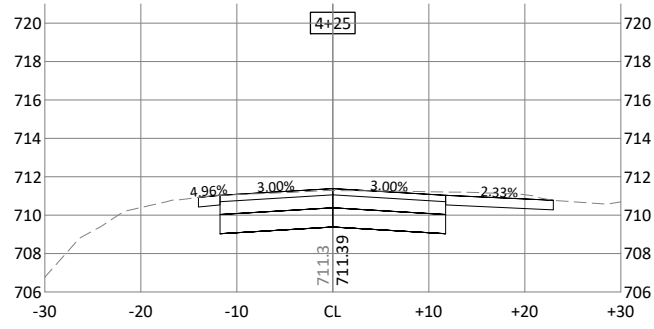
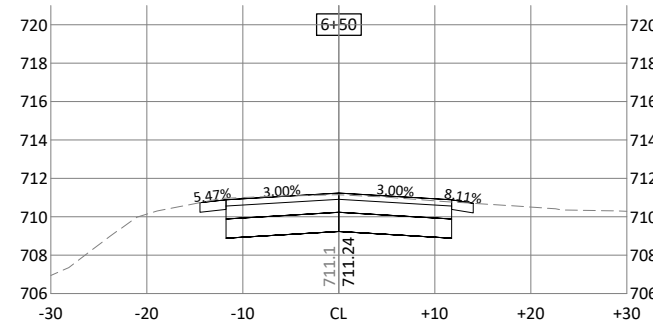
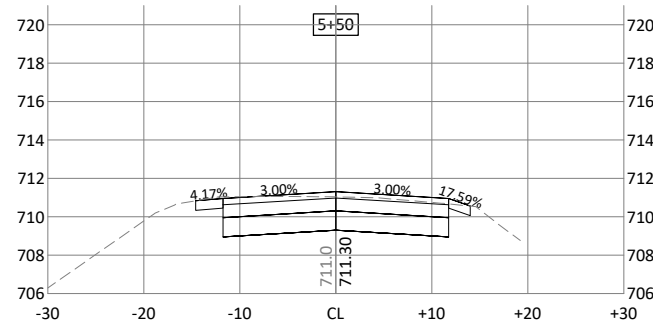
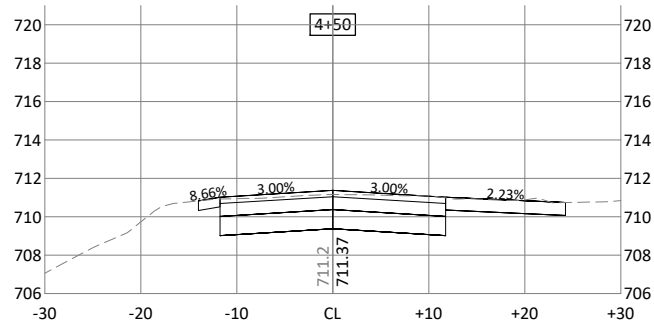
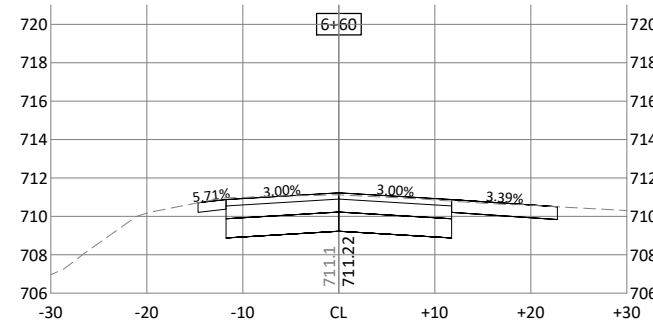
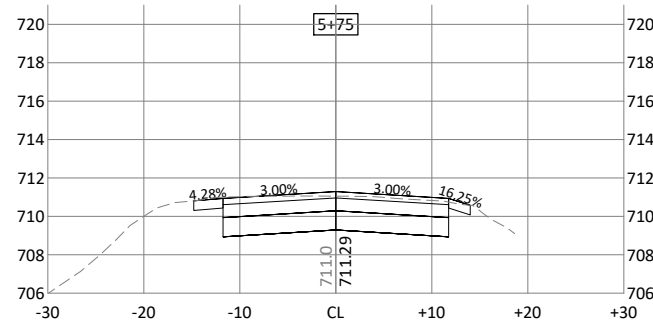
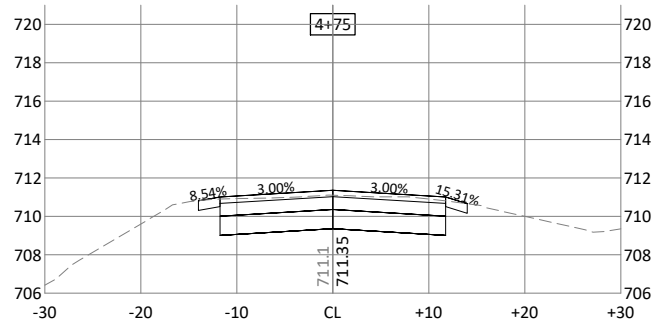

© Bolton & Menk, Inc. 2023. All Rights Reserved. PL:\DWG\MINN\_VD\_MIN01129866\CAD\CSD\129866.CSD.dwg 1/25/2024 4:17:08 PM

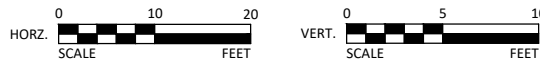

I HEREBY CERTIFY THAT THIS PLAN, SPECIFICATION, OR REPORT WAS PREPARED BY ME OR UNDER MY DIRECT SUPERVISION AND THAT I AM A DULY LICENSED PROFESSIONAL ENGINEER UNDER THE LAWS OF THE STATE OF MINNESOTA.

*Bradley J Fisher*  
 BRADLEY J FISHER  
 LIC. NO. 56595 DATE 02/21/2024



12224 NICOLLET AVENUE  
 BURNSVILLE, MINNESOTA 55337  
 Phone: (952) 890-0509  
 Email: Burnsville@bolton-menk.com  
 www.bolton-menk.com

DESIGNED	NO.	ISSUED FOR	DATE
JLW			
DRAWN			
JLW			
CHECKED			
BJF			
CLIENT PROJ. NO.			
011.129866			

LOWER MINNESOTA RIVER WATERSHED DISTRICT  
 VERNON AVENUE IMPROVEMENTS  
 CROSS SECTIONS  
 VERNON AVENUE

SHEET  
**C8.02**

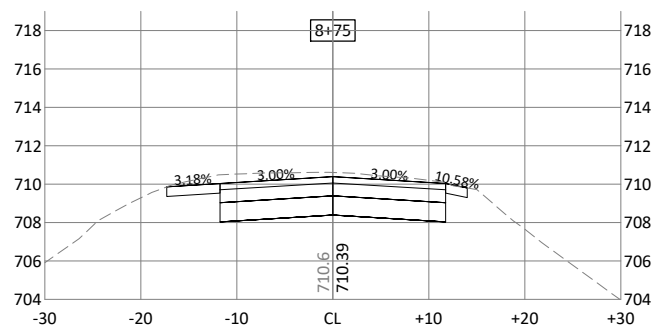
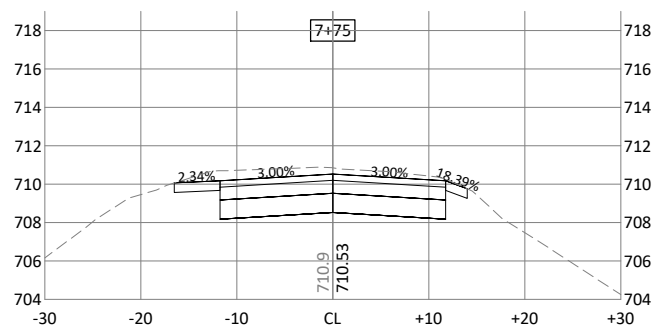
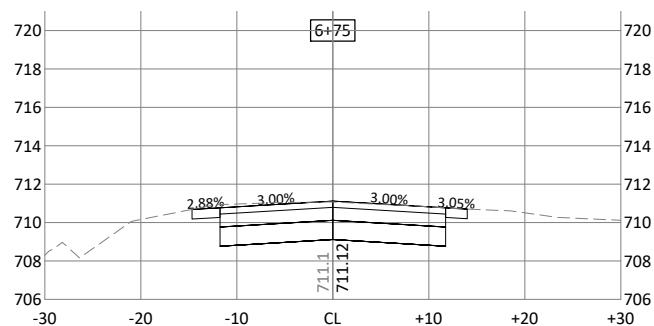
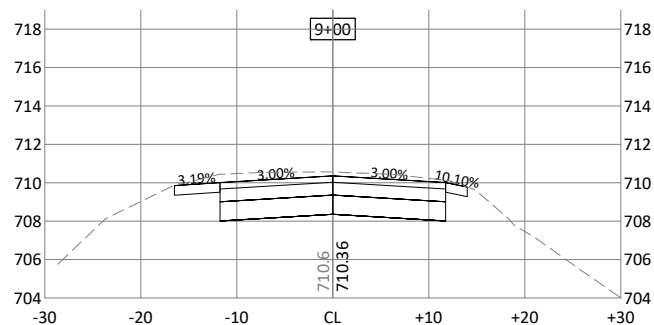
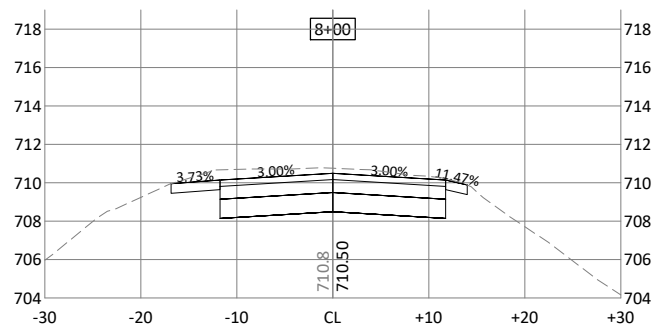
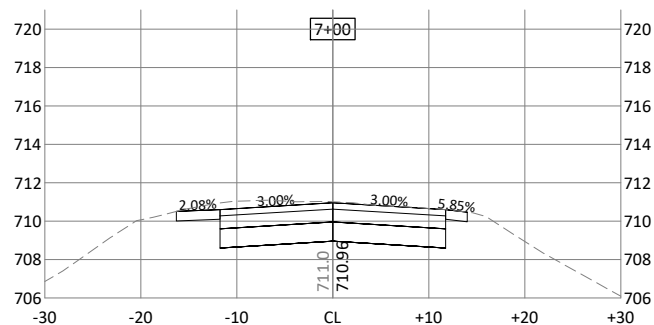
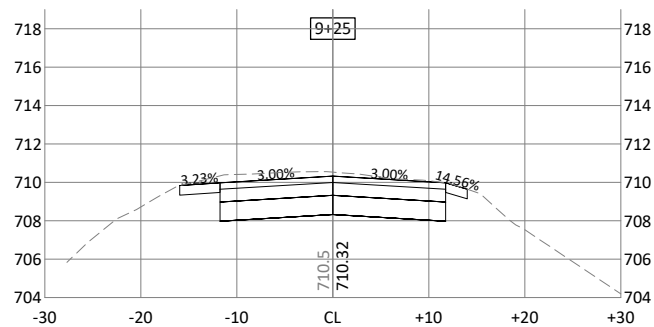
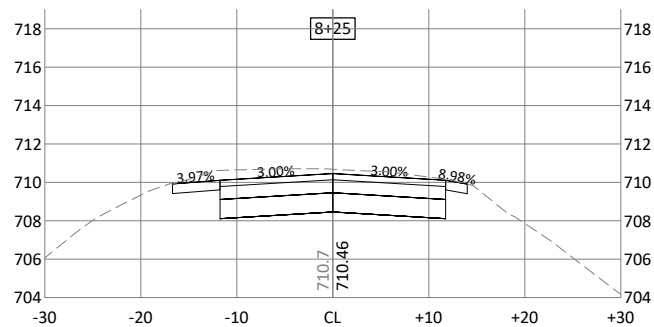
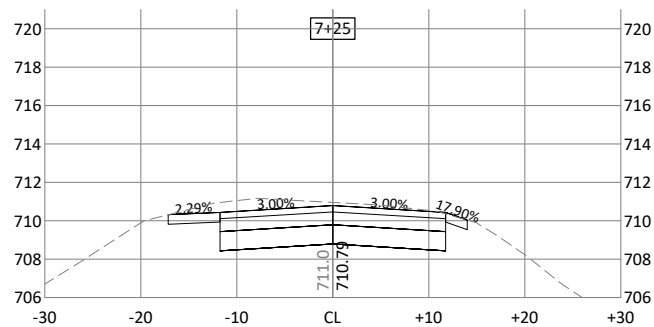
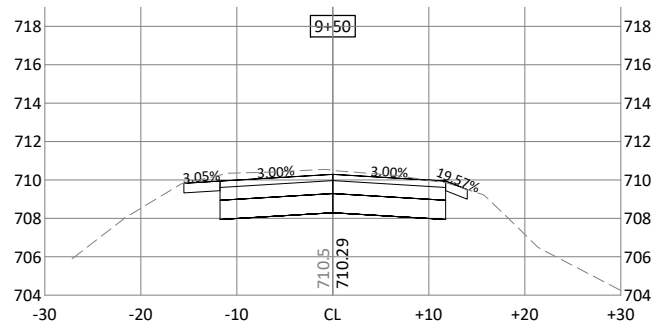
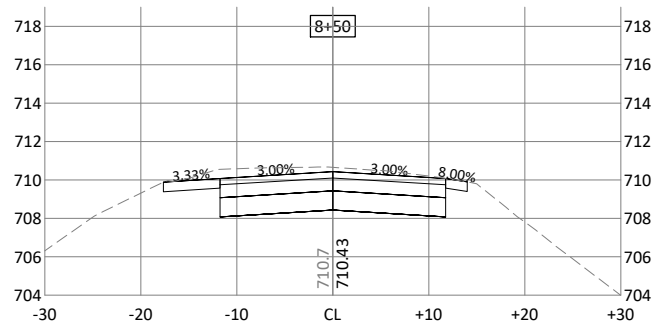
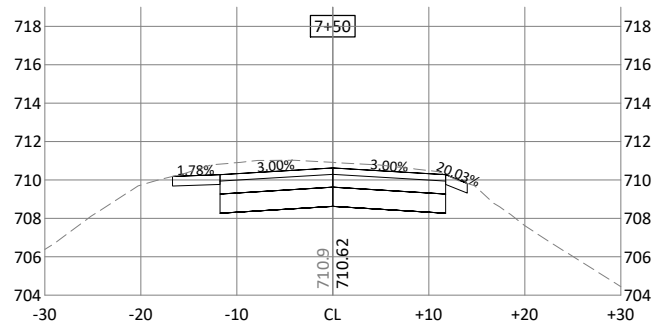

© Bolton & Menk, Inc. 2023. All Rights Reserved. P:\LOWMINN\_RIVER\112986\CAD\12986\66601.dwg 1/25/2024 4:17:10 PM

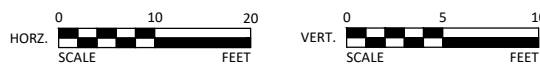

I HEREBY CERTIFY THAT THIS PLAN, SPECIFICATION, OR REPORT WAS PREPARED BY ME OR UNDER MY DIRECT SUPERVISION AND THAT I AM A DULY LICENSED PROFESSIONAL ENGINEER UNDER THE LAWS OF THE STATE OF MINNESOTA.

*Bradley J Fisher*  
 BRADLEY J FISHER  
 LIC. NO. 56595 DATE 02/21/2024



12224 NICOLLET AVENUE  
 BURNSVILLE, MINNESOTA 55337  
 Phone: (952) 890-0509  
 Email: Burnsville@bolton-menk.com  
 www.bolton-menk.com

DESIGNED	NO.	ISSUED FOR	DATE
JLW			
DRAWN			
JLW			
CHECKED			
BJF			
CLIENT PROJ. NO.			
01129866			

LOWER MINNESOTA RIVER WATERSHED DISTRICT  
 VERNON AVENUE IMPROVEMENTS  
 CROSS SECTIONS  
 VERNON AVE N

SHEET  
**C8.03**

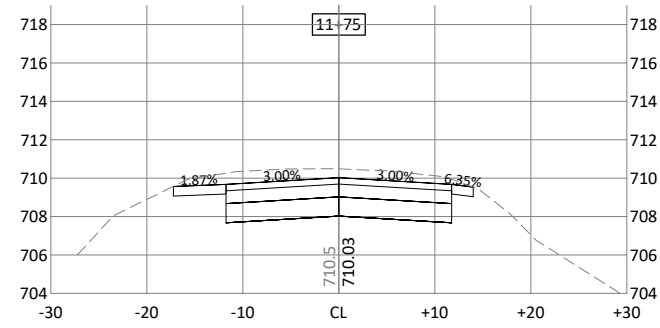
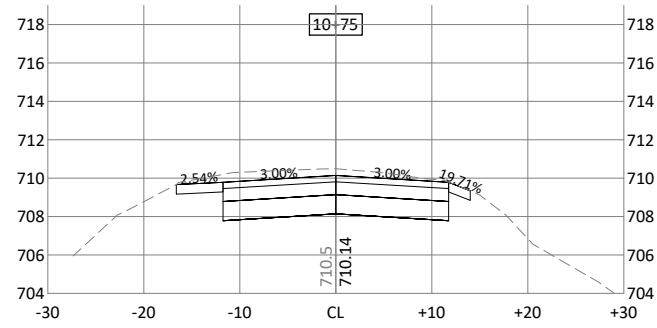
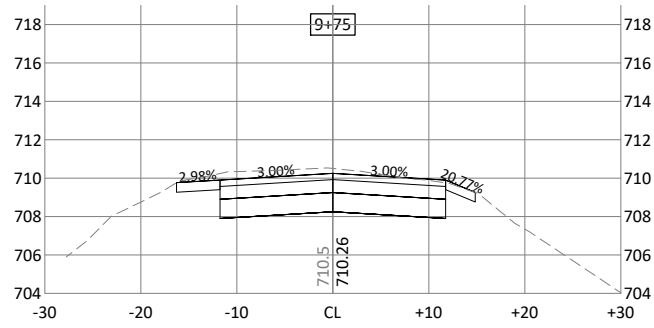
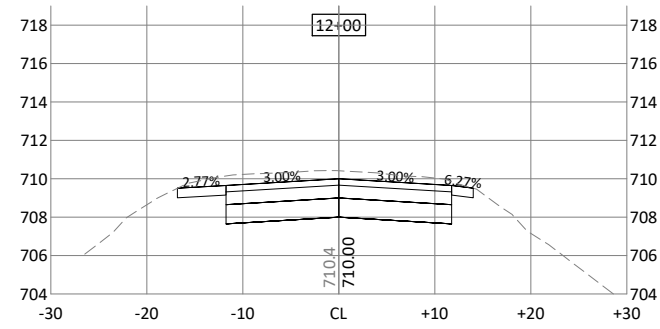
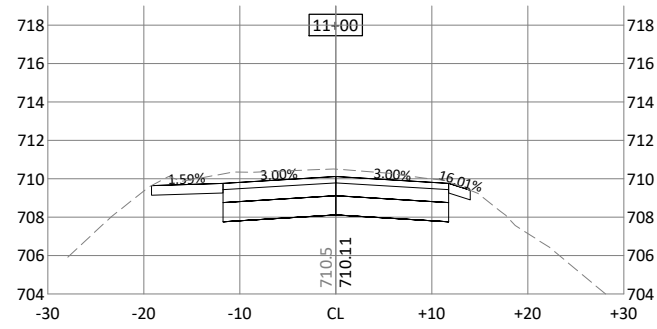
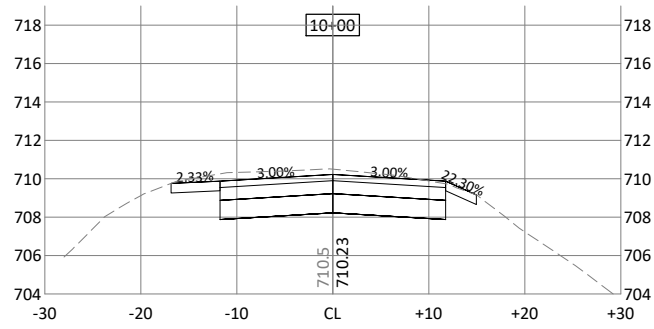
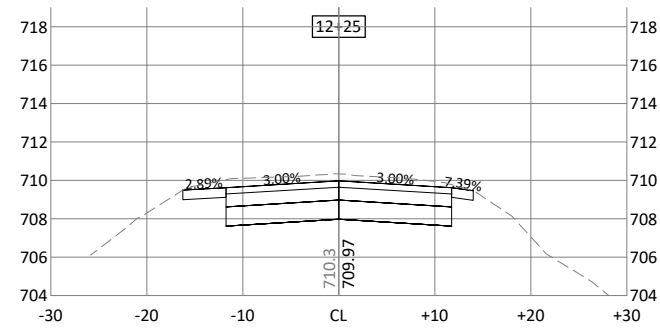
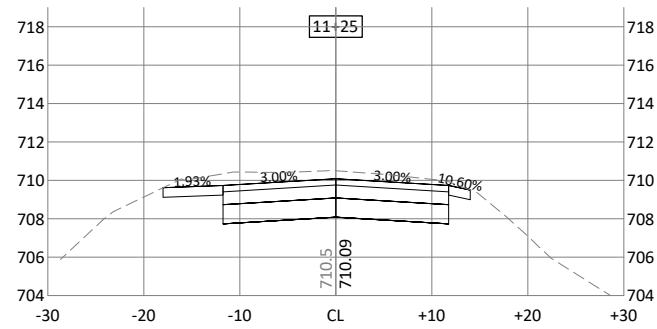
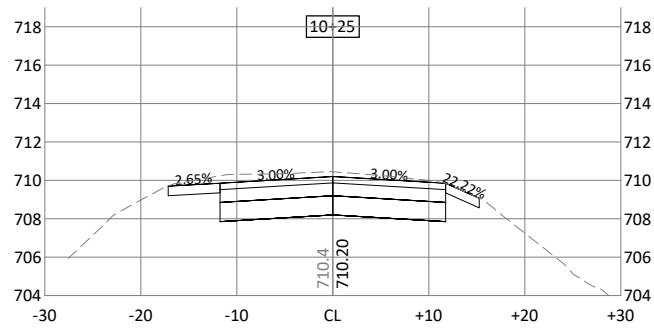
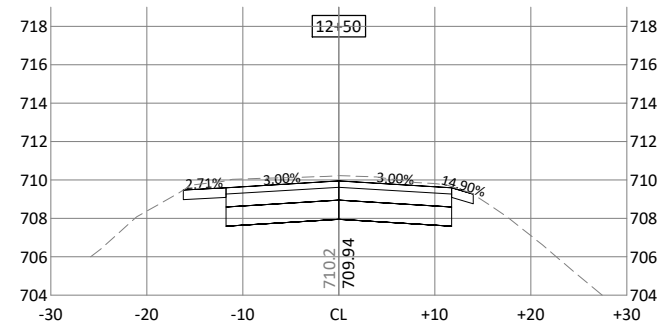
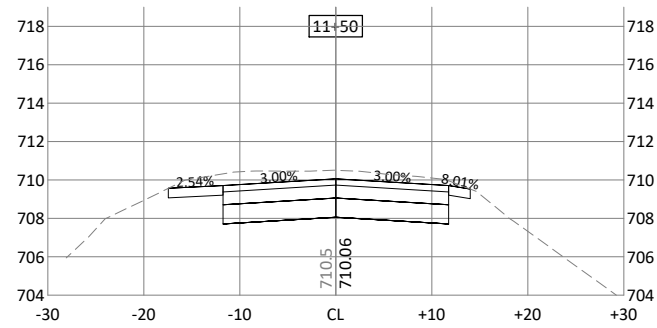
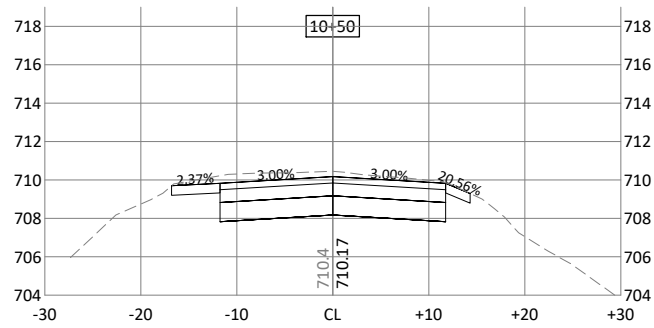

© Bolton & Menk, Inc. 2023. All Rights Reserved. 11/20/2023 11:38:51 AM C:\D:\29866501.dwg 1/25/2024 4:17:11 PM

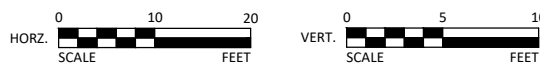

I HEREBY CERTIFY THAT THIS PLAN, SPECIFICATION, OR REPORT WAS PREPARED BY ME OR UNDER MY DIRECT SUPERVISION AND THAT I AM A DULY LICENSED PROFESSIONAL ENGINEER UNDER THE LAWS OF THE STATE OF MINNESOTA.

*Bradley J Fisher*  
 BRADLEY J FISHER  
 LIC. NO. 56595 DATE 02/21/2024



12224 NICOLLET AVENUE  
 BURNSVILLE, MINNESOTA 55337  
 Phone: (952) 890-0509  
 Email: Burnsville@bolton-menk.com  
 www.bolton-menk.com

DESIGNED	NO.	ISSUED FOR	DATE
JLW			
DRAWN			
JLW			
CHECKED			
BJF			
CLIENT PROJ. NO.			
0T1.129866			

LOWER MINNESOTA RIVER WATERSHED DISTRICT  
 VERNON AVENUE IMPROVEMENTS  
 CROSS SECTIONS  
 VERNON AVE N

SHEET  
**C8.04**

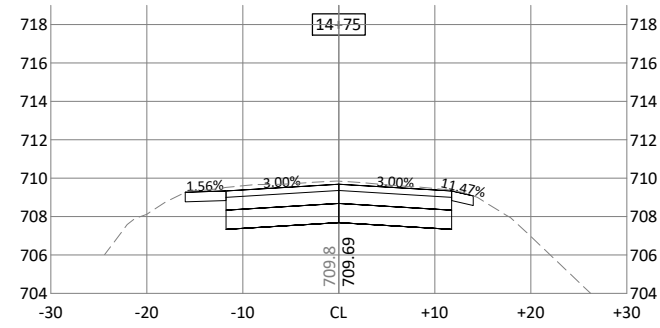
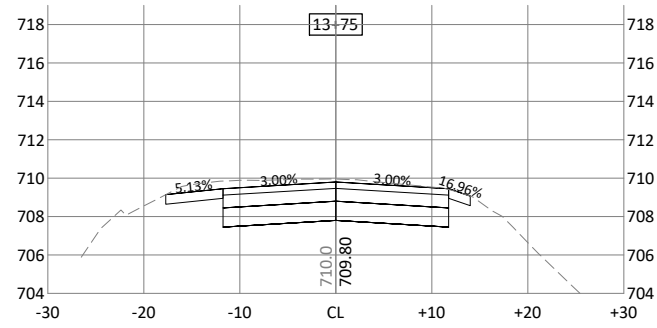
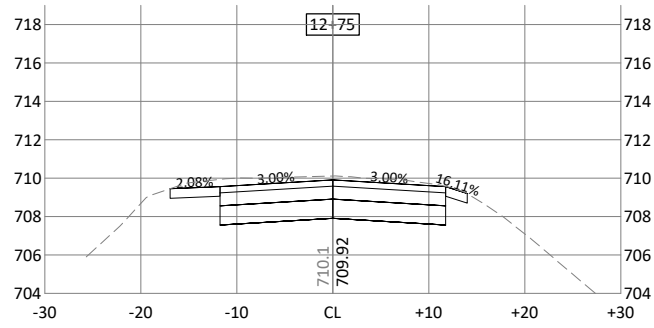
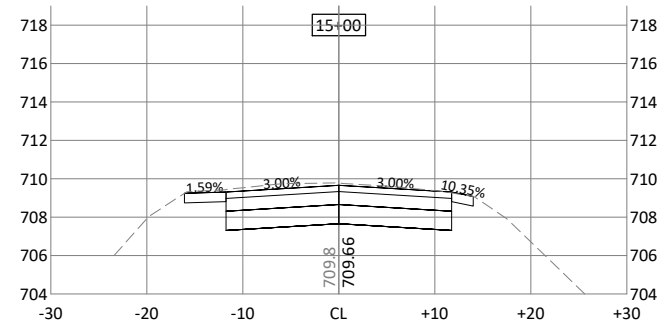
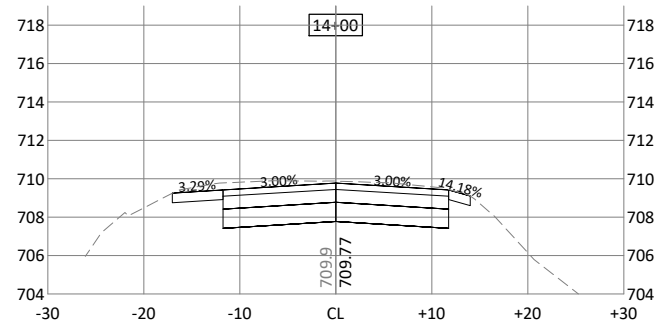
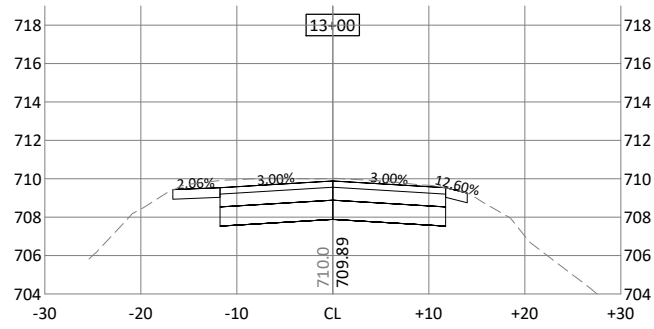
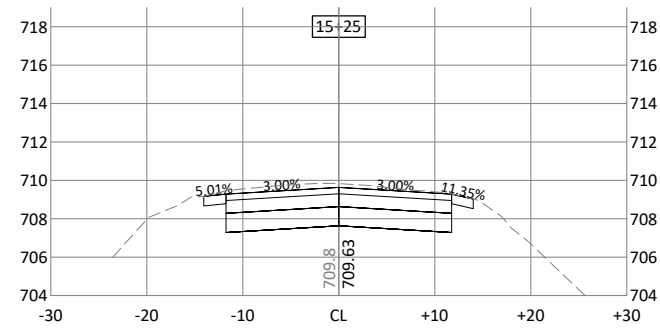
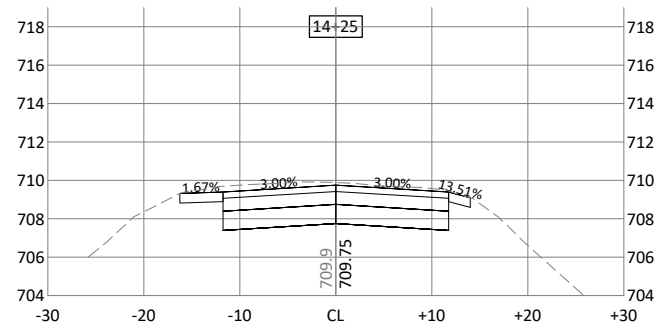
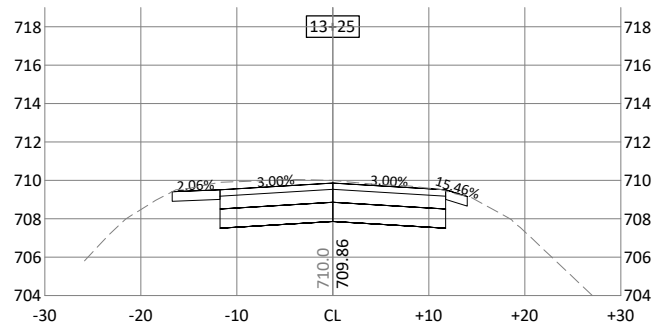
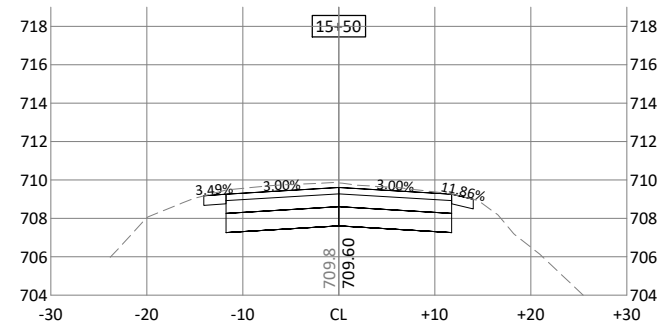
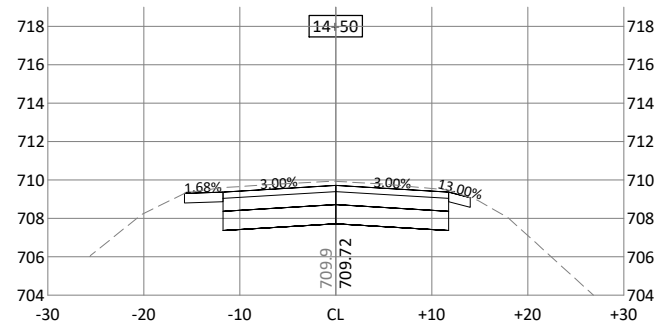
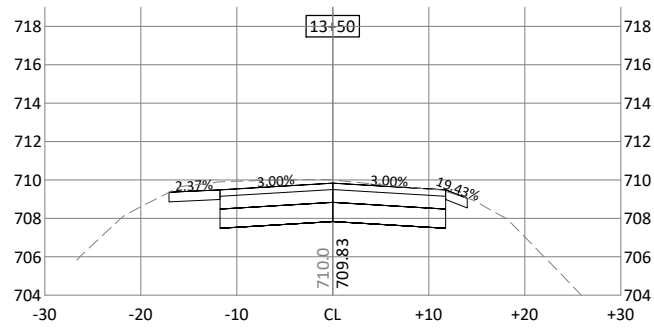

© Bolton & Menk, Inc. 2023. All Rights Reserved. P:\LOWMINN\112986\CAD\CROSS\12986\C8.01.dwg 1/25/2024 4:17:12 PM

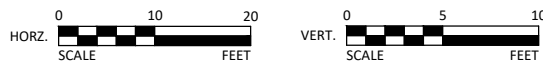

I HEREBY CERTIFY THAT THIS PLAN, SPECIFICATION, OR REPORT WAS PREPARED BY ME OR UNDER MY DIRECT SUPERVISION AND THAT I AM A DULY LICENSED PROFESSIONAL ENGINEER UNDER THE LAWS OF THE STATE OF MINNESOTA.

*Bradley J Fisher*  
 BRADLEY J FISHER  
 LIC. NO. 56595 DATE 02/21/2024



12224 NICOLLET AVENUE  
 BURNSVILLE, MINNESOTA 55337  
 Phone: (952) 890-0509  
 Email: Burnsville@bolton-menk.com  
 www.bolton-menk.com

DESIGNED	NO.	ISSUED FOR	DATE
JLW			
DRAWN	JLW		
CHECKED	BJF		
CLIENT PROJ. NO.	0T1.129866		

LOWER MINNESOTA RIVER WATERSHED DISTRICT  
 VERNON AVENUE IMPROVEMENTS  
 CROSS SECTIONS  
 VERNON AVE N

SHEET  
**C8.05**

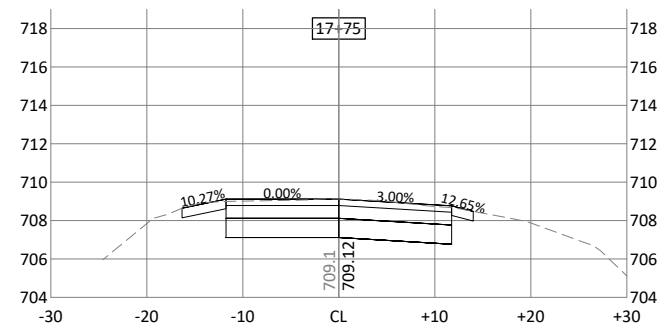
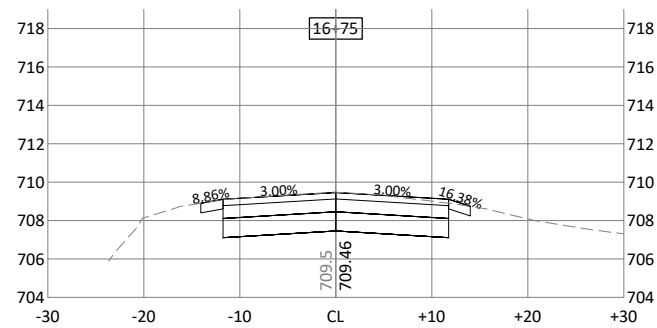
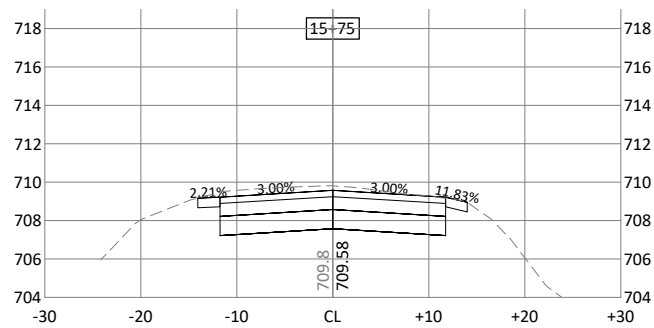
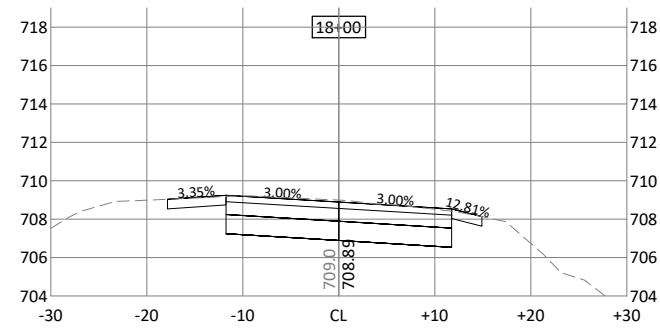
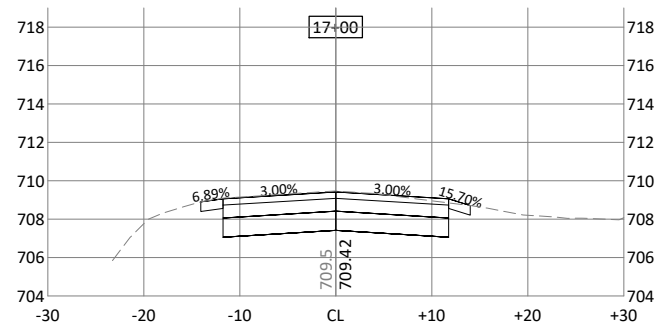
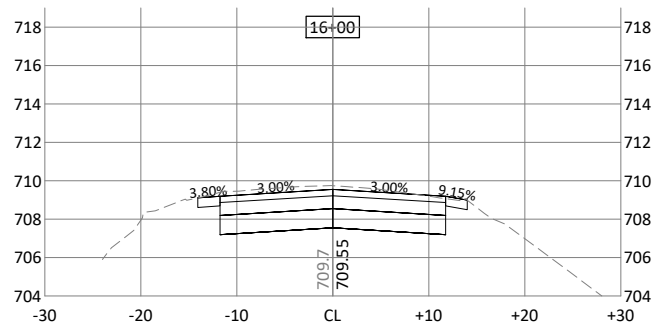
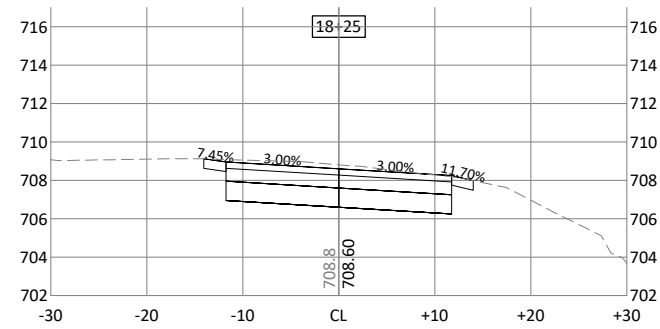
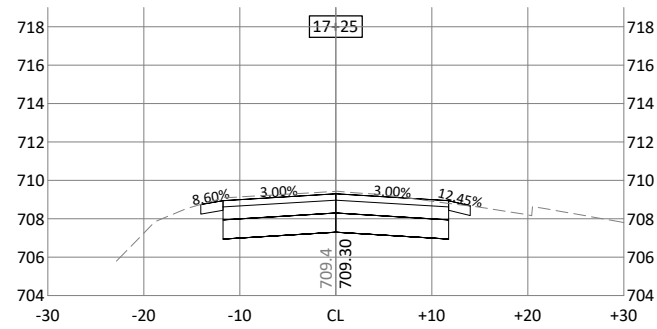
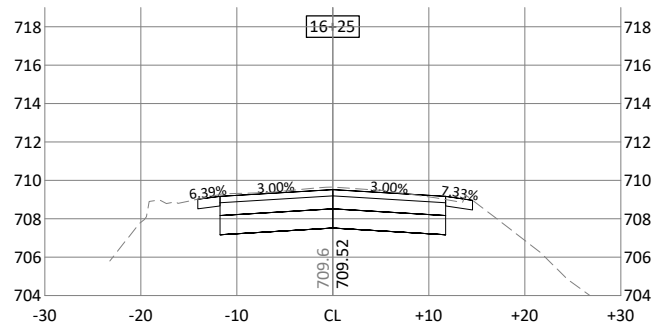
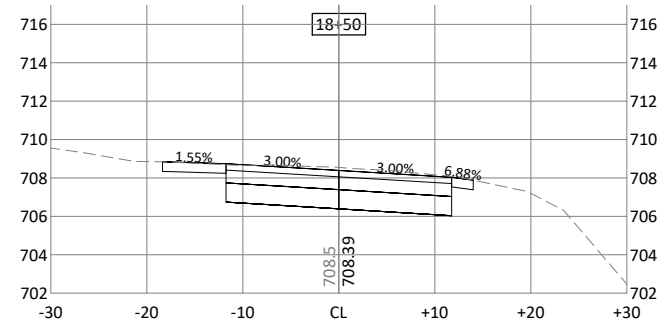
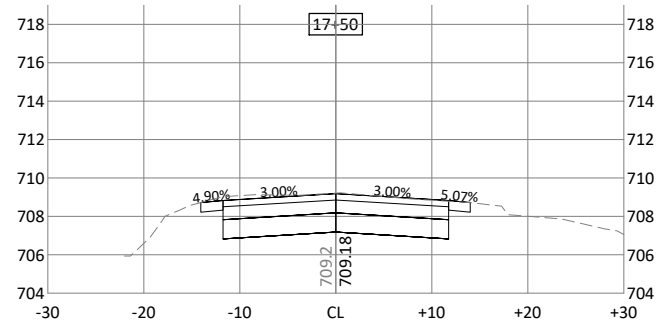
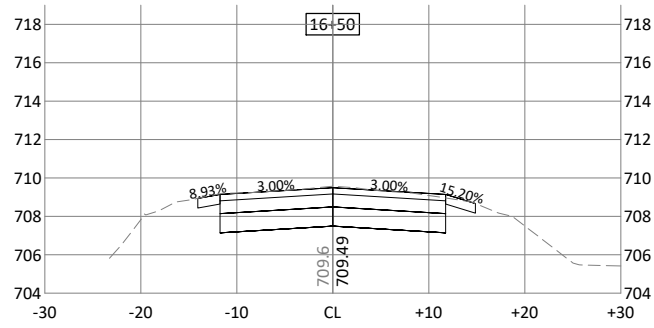

© Bolton & Menk, Inc. 2023. All Rights Reserved. PROJECT: LOWER MINNESOTA RIVER WATERSHED DISTRICT, VERNON AVENUE IMPROVEMENTS, DRAWING: C8.00, DATE: 02/21/2024, 4:17:14 PM

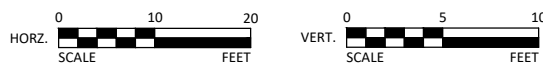

I HEREBY CERTIFY THAT THIS PLAN, SPECIFICATION, OR REPORT WAS PREPARED BY ME OR UNDER MY DIRECT SUPERVISION AND THAT I AM A DULY LICENSED PROFESSIONAL ENGINEER UNDER THE LAWS OF THE STATE OF MINNESOTA.  
*Bradley J Fisher*  
 BRADLEY J FISHER  
 LIC. NO. 56595 DATE 02/21/2024



12224 NICOLLET AVENUE  
 BURNSVILLE, MINNESOTA 55337  
 Phone: (952) 890-0509  
 Email: Burnsville@bolton-menk.com  
 www.bolton-menk.com

DESIGNED	NO.	ISSUED FOR	DATE
JLW			
DRAWN			
JLW			
CHECKED			
BJF			
CLIENT PROJ. NO.			
0T1.129866			

LOWER MINNESOTA RIVER WATERSHED DISTRICT  
 VERNON AVENUE IMPROVEMENTS  
 CROSS SECTIONS  
 VERNON AVENUE

SHEET  
**C8.06**

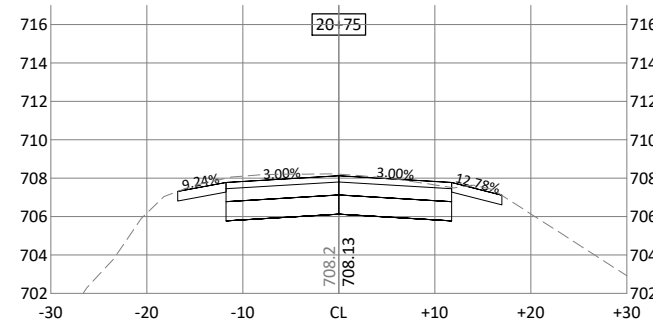
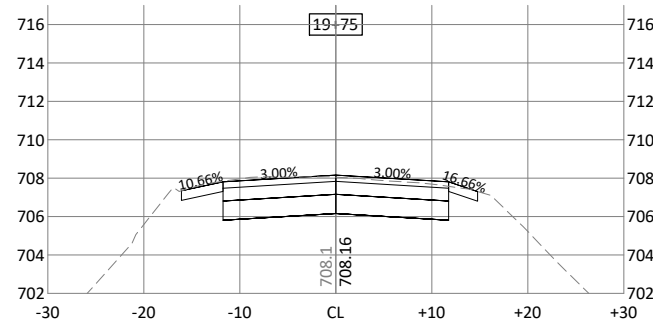
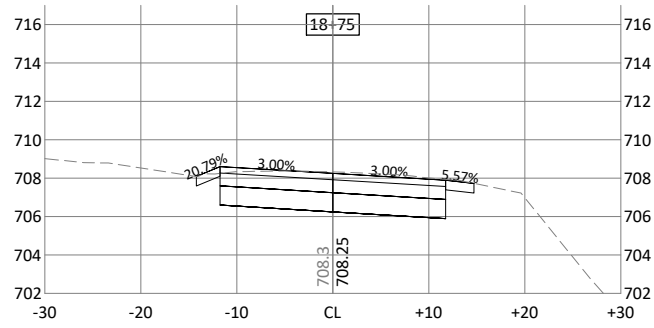
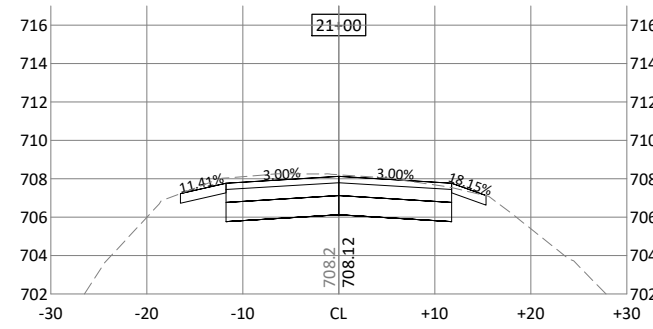
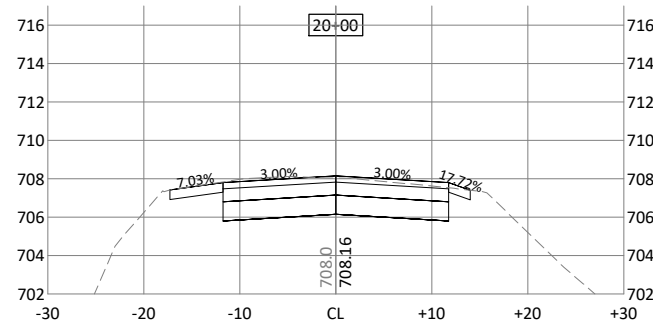
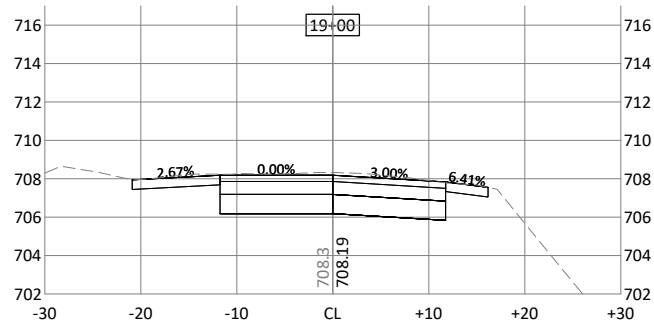
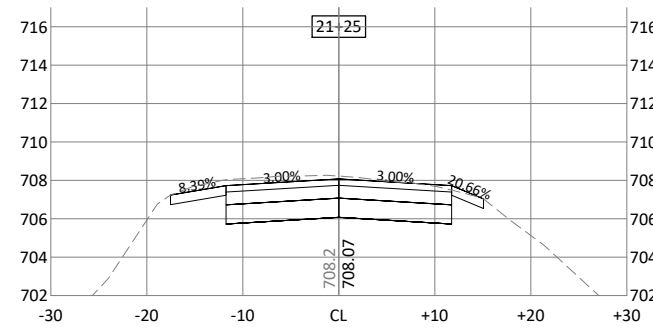
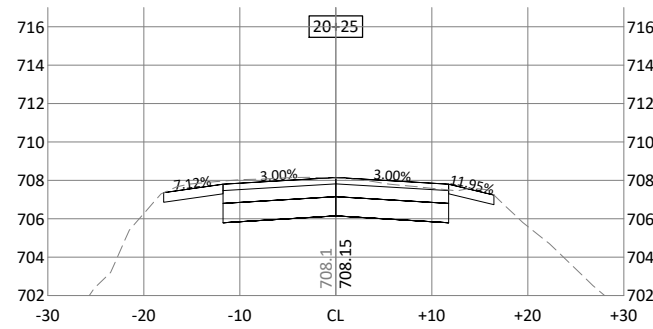
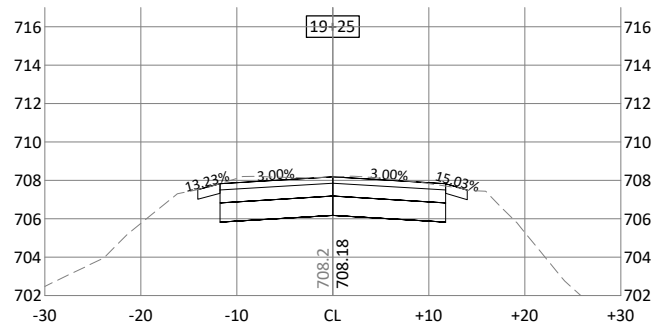
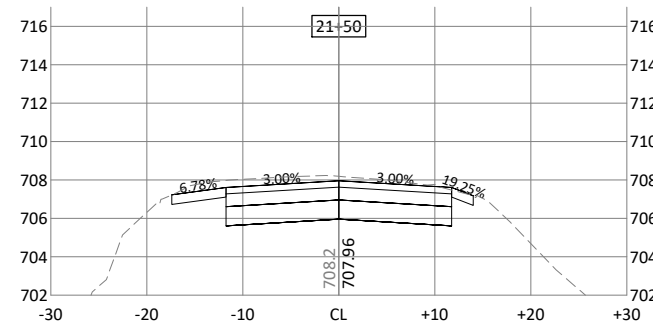
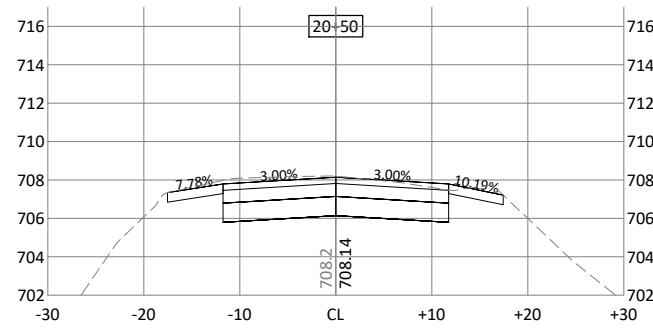
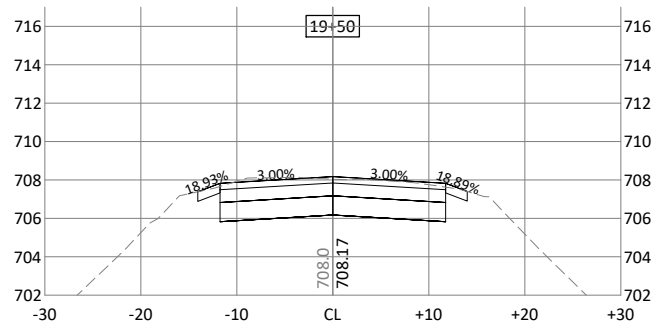

© Bolton & Menk, Inc. 2023. All Rights Reserved. 1:LOWMINN\_VA\_20230112\_38651\_CAD\_1298666801.dwg 1/25/2024 4:17:15 PM

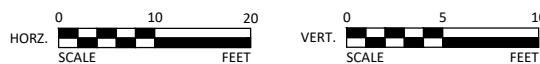

I HEREBY CERTIFY THAT THIS PLAN, SPECIFICATION, OR REPORT WAS PREPARED BY ME OR UNDER MY DIRECT SUPERVISION AND THAT I AM A DULY LICENSED PROFESSIONAL ENGINEER UNDER THE LAWS OF THE STATE OF MINNESOTA.

*Bradley J Fisher*  
 BRADLEY J FISHER  
 LIC. NO. 56595 DATE 02/21/2024



12224 NICOLLET AVENUE  
 BURNSVILLE, MINNESOTA 55337  
 Phone: (952) 890-0509  
 Email: Burnsville@bolton-menk.com  
 www.bolton-menk.com

DESIGNED	NO.	ISSUED FOR	DATE
JLW			
DRAWN	JLW		
CHECKED	BJF		
CLIENT PROJ. NO.	0T1.129866		

LOWER MINNESOTA RIVER WATERSHED DISTRICT  
 VERNON AVENUE IMPROVEMENTS  
 CROSS SECTIONS  
 VERNON AVENUE

SHEET  
**C8.07**



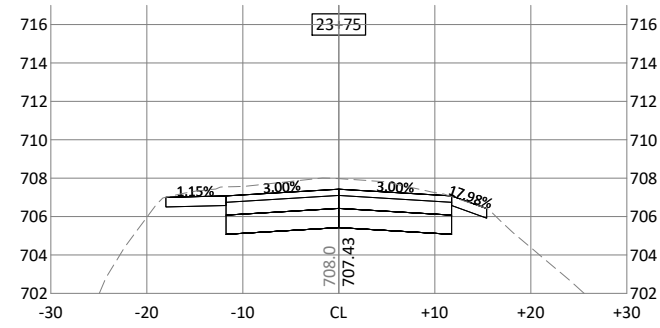
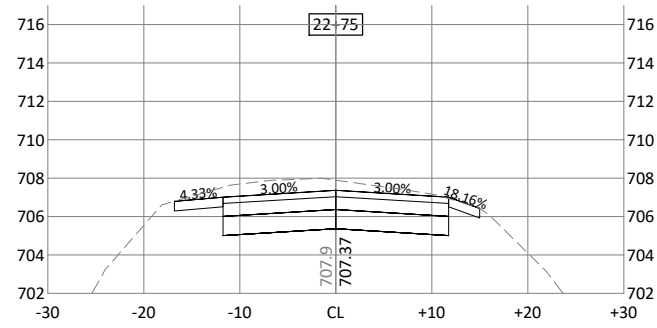
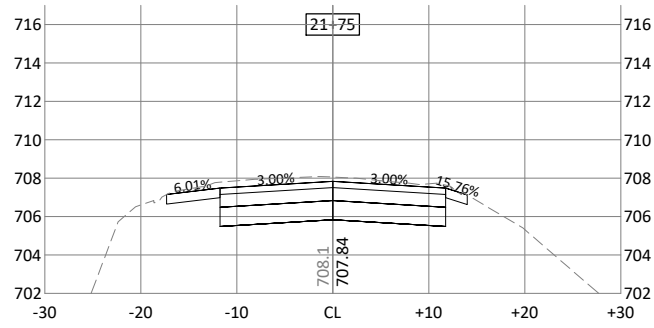
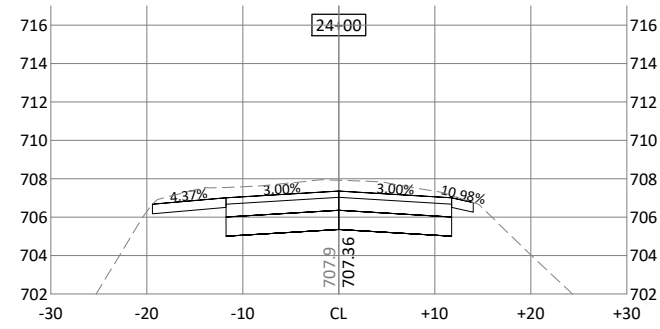
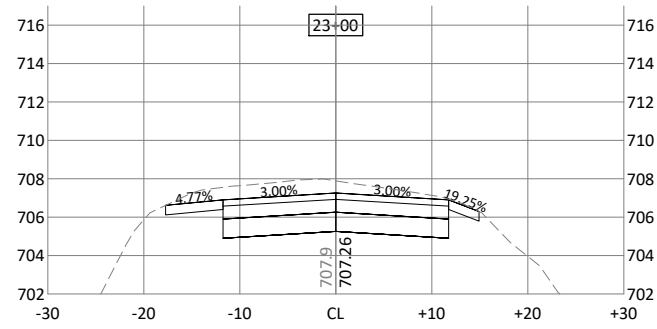
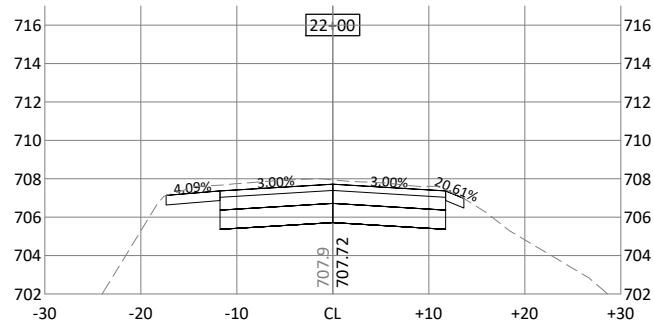
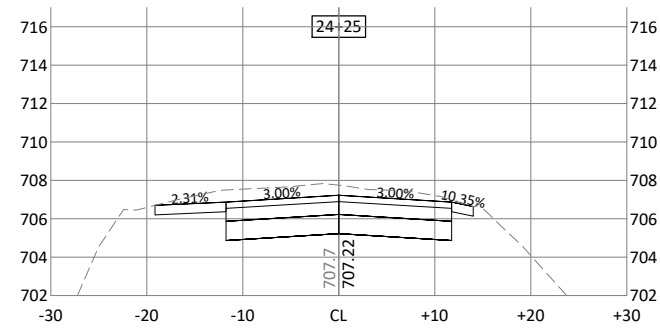
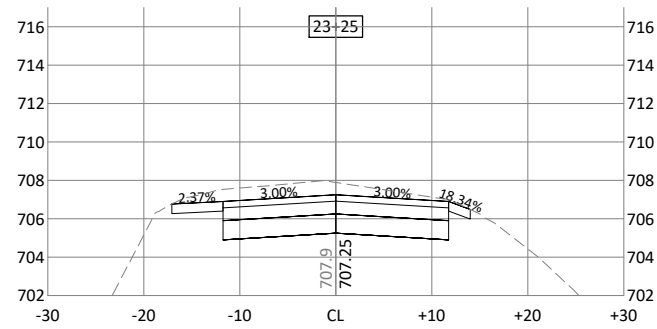
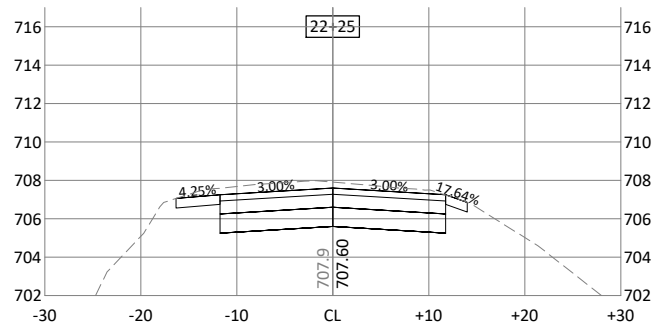
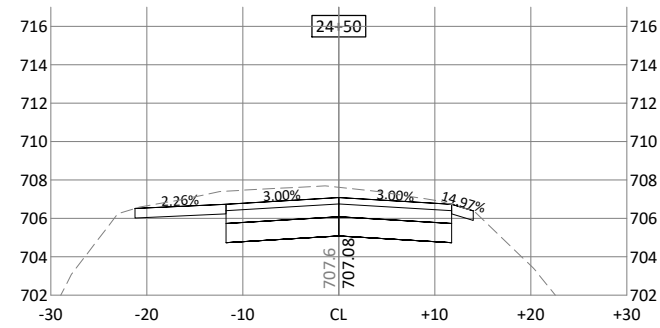
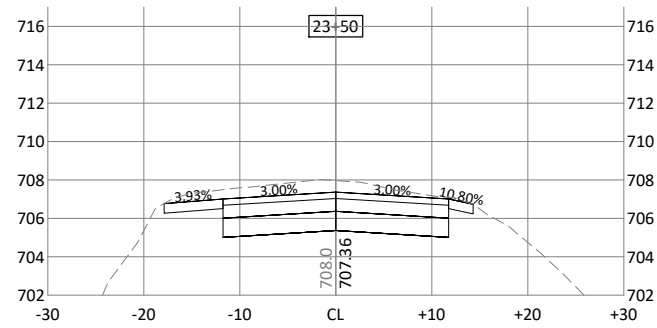
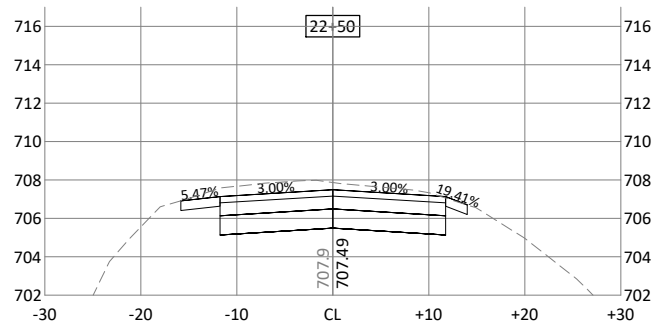

© Bolton & Menk, Inc. 2023. All Rights Reserved. 11/20/2024 11:38:51 AM. 1/25/2024 4:17:16 PM

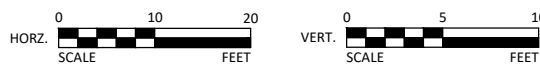

I HEREBY CERTIFY THAT THIS PLAN, SPECIFICATION, OR REPORT WAS PREPARED BY ME OR UNDER MY DIRECT SUPERVISION AND THAT I AM A DULY LICENSED PROFESSIONAL ENGINEER UNDER THE LAWS OF THE STATE OF MINNESOTA.

*Bradley J Fisher*  
 BRADLEY J FISHER  
 LIC. NO. 56595 DATE 02/21/2024



12224 NICOLLET AVENUE  
 BURNSVILLE, MINNESOTA 55337  
 Phone: (952) 890-0509  
 Email: Burnsville@bolton-menk.com  
 www.bolton-menk.com

DESIGNED	NO.	ISSUED FOR	DATE
JLW			
DRAWN	JLW		
CHECKED	BJF		
CLIENT PROJ. NO.	0T1.129866		

LOWER MINNESOTA RIVER WATERSHED DISTRICT  
 VERNON AVENUE IMPROVEMENTS  
 CROSS SECTIONS  
 VERNON AVE N

SHEET  
**C8.08**

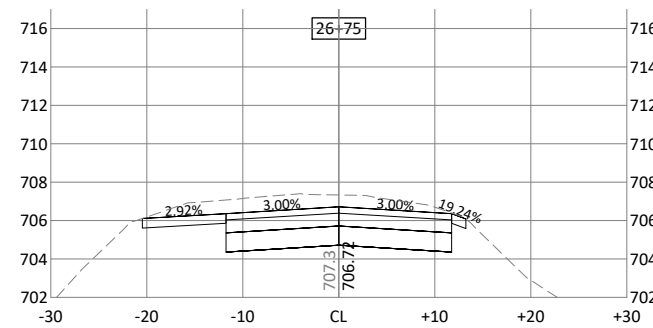
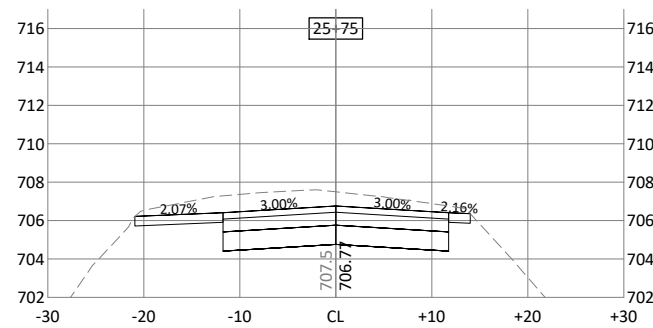
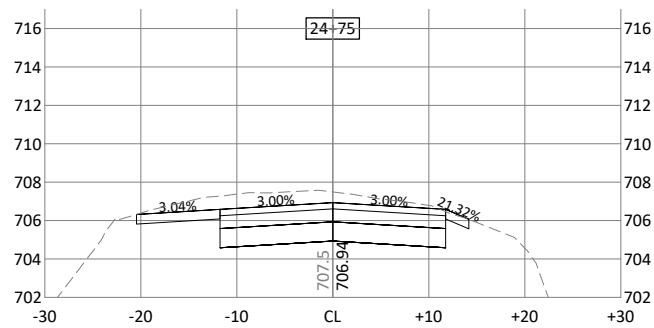
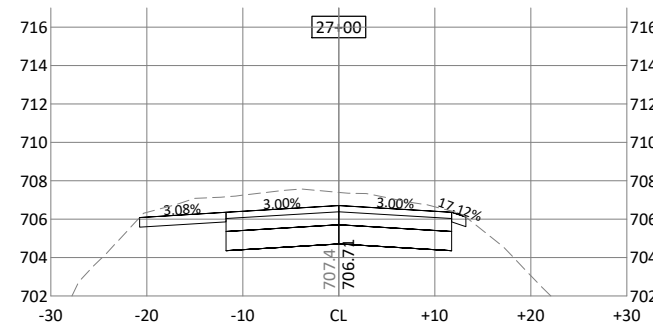
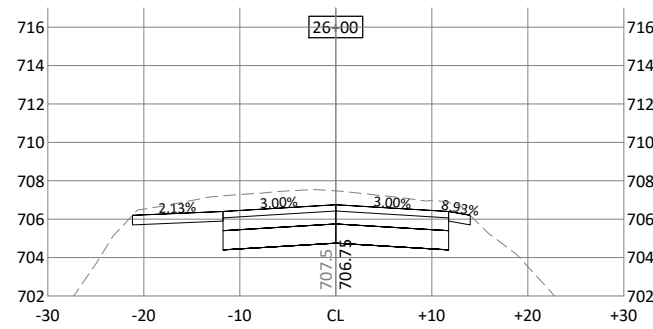
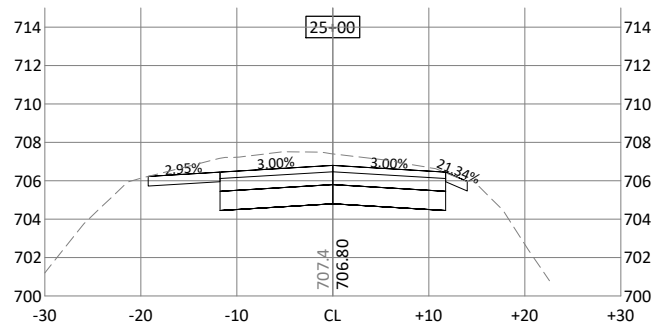
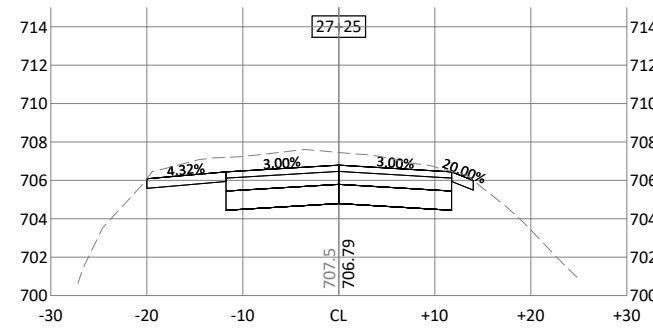
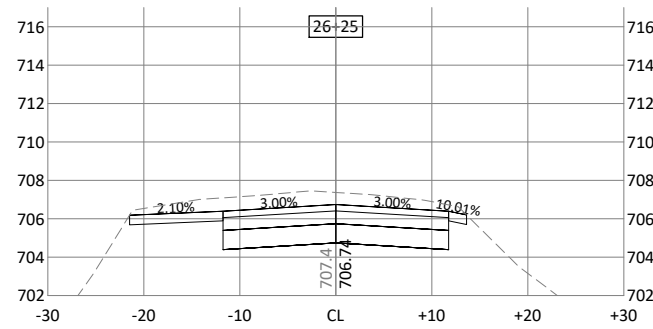
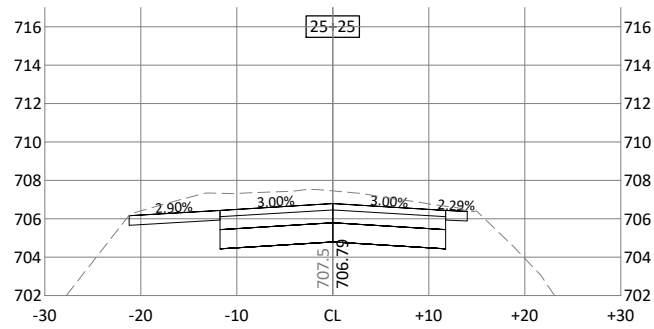
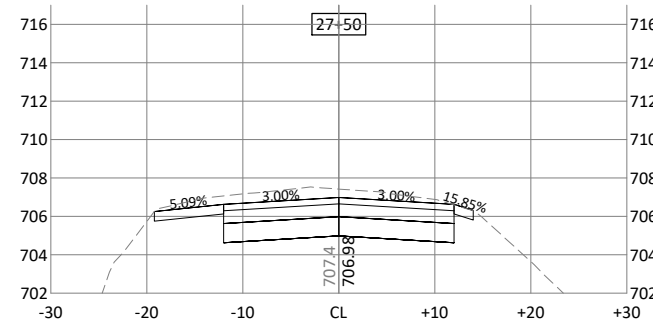
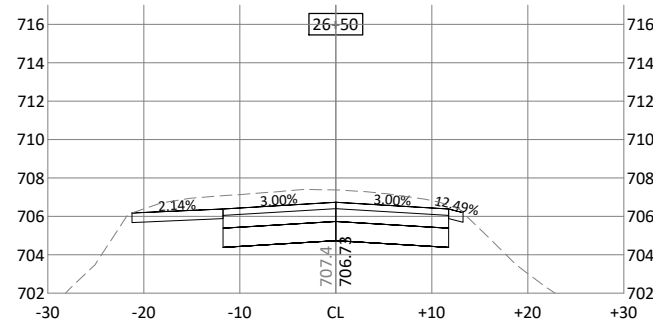
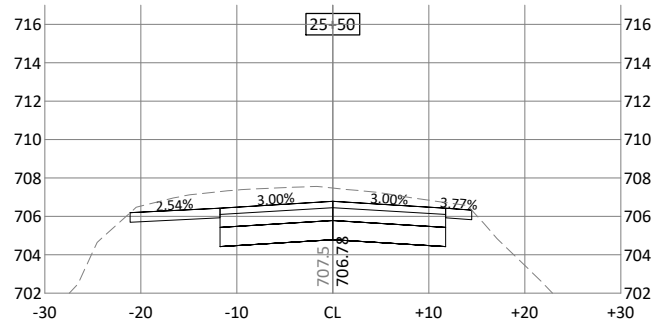

© Bolton & Menk, Inc. 2023. All Rights Reserved. P:\LOWMINN\112986\CAD\24-29\25+00.dwg 1/25/2024 4:17:18 PM

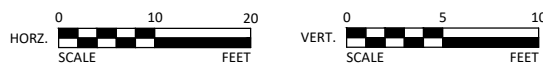

I HEREBY CERTIFY THAT THIS PLAN, SPECIFICATION, OR REPORT WAS PREPARED BY ME OR UNDER MY DIRECT SUPERVISION AND THAT I AM A DULY LICENSED PROFESSIONAL ENGINEER UNDER THE LAWS OF THE STATE OF MINNESOTA.  
*Bradley J Fisher*  
 BRADLEY J FISHER  
 LIC. NO. 56595 DATE 02/21/2024



12224 NICOLLET AVENUE  
 BURNSVILLE, MINNESOTA 55337  
 Phone: (952) 890-0509  
 Email: Burnsville@bolton-menk.com  
 www.bolton-menk.com

DESIGNED	NO.	ISSUED FOR	DATE
JLW			
DRAWN			
JLW			
CHECKED			
BJF			
CLIENT PROJ. NO.			
011.129866			

LOWER MINNESOTA RIVER WATERSHED DISTRICT  
 VERNON AVENUE IMPROVEMENTS  
 CROSS SECTIONS  
 VERNON AVE N

SHEET

C8.09

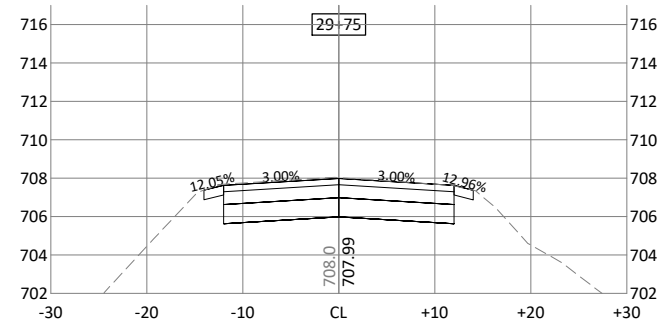
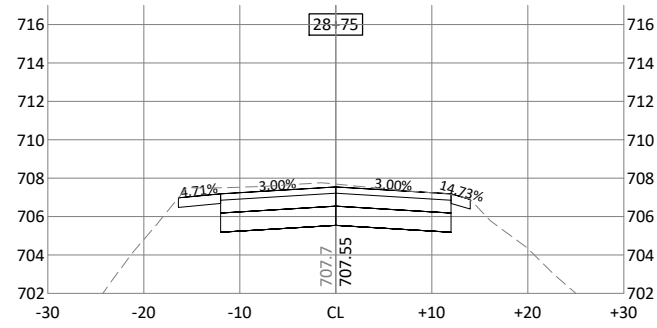
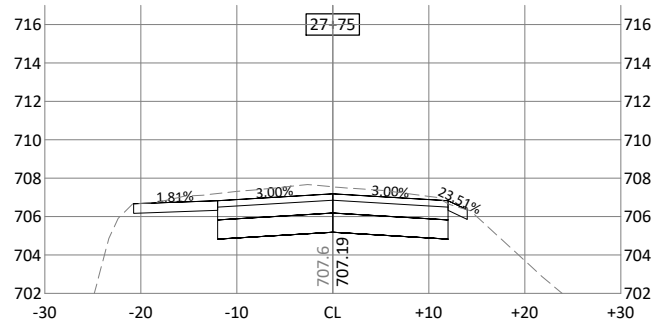
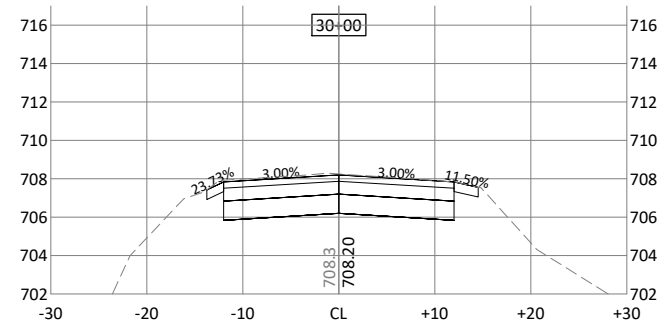
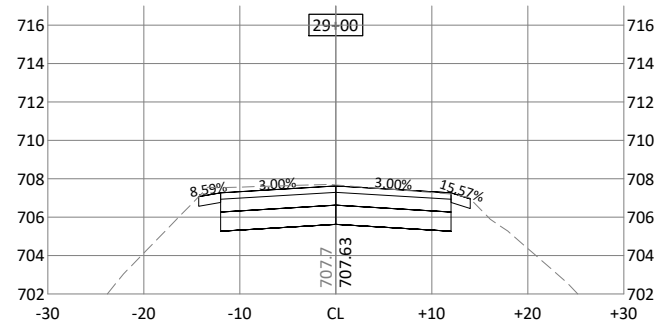
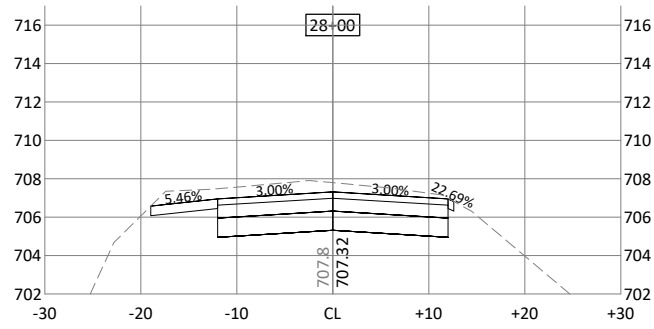
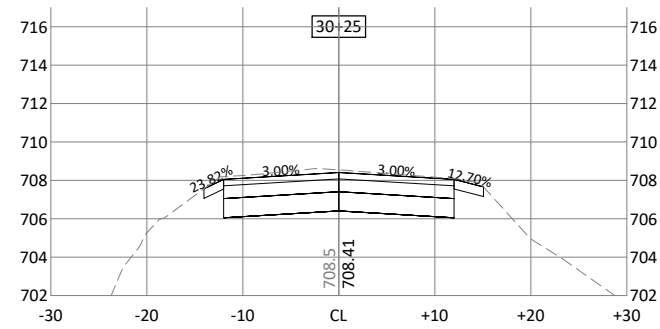
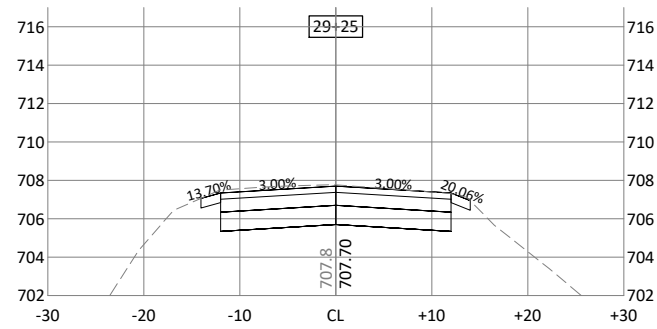
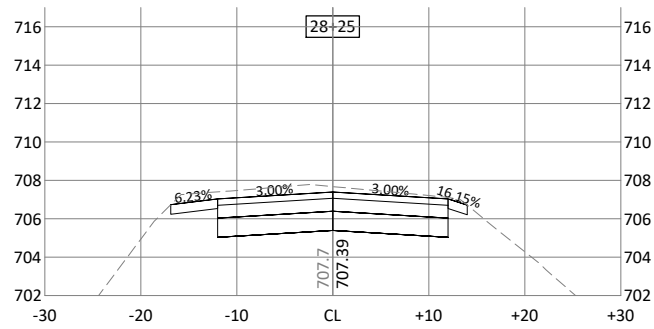
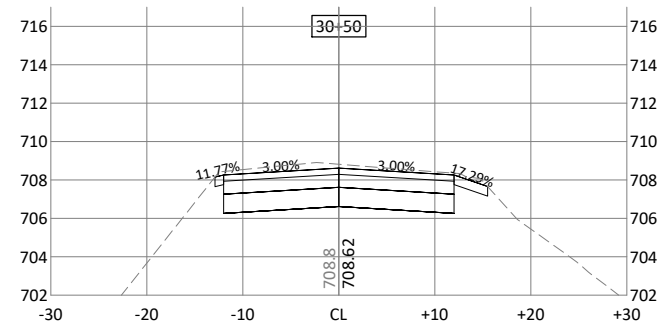
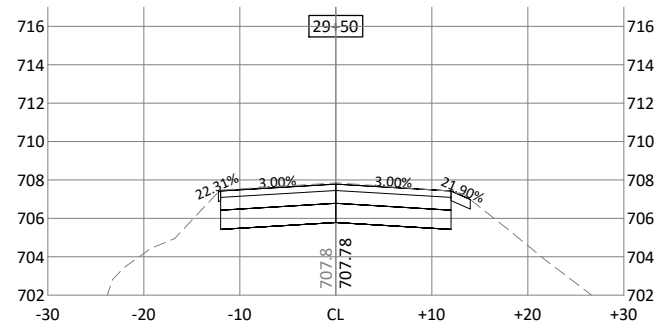
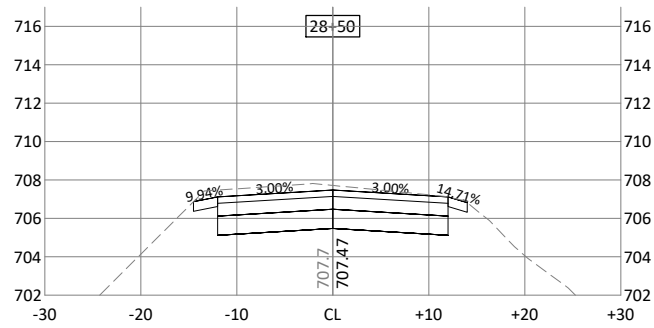

© Bolton & Menk, Inc. 2023. All Rights Reserved. P:\LOWMINN\122986\CD\122986.dwg 1/25/2024 4:17:19 PM

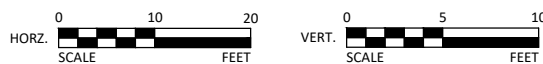

I HEREBY CERTIFY THAT THIS PLAN, SPECIFICATION, OR REPORT WAS PREPARED BY ME OR UNDER MY DIRECT SUPERVISION AND THAT I AM A DULY LICENSED PROFESSIONAL ENGINEER UNDER THE LAWS OF THE STATE OF MINNESOTA.  
*Bradley J Fisher*  
 BRADLEY J FISHER  
 LIC. NO. 56595 DATE 02/21/2024



12224 NICOLLET AVENUE  
 BURNSVILLE, MINNESOTA 55337  
 Phone: (952) 890-0509  
 Email: Burnsville@bolton-menk.com  
 www.bolton-menk.com

DESIGNED	NO.	ISSUED FOR	DATE
JLW			
DRAWN	JLW		
CHECKED	BJF		
CLIENT PROJ. NO.	0T1.129866		

LOWER MINNESOTA RIVER WATERSHED DISTRICT  
 VERNON AVENUE IMPROVEMENTS  
 CROSS SECTIONS  
 VERNON AVE N

SHEET  
**C8.10**

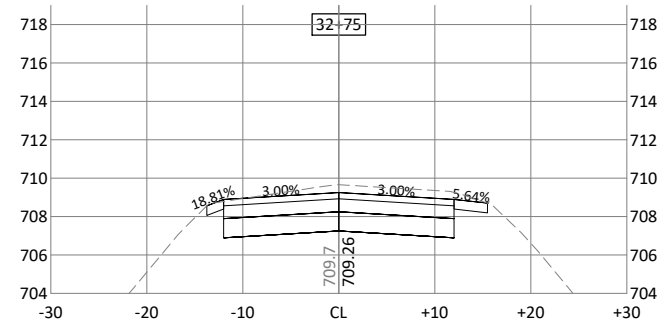
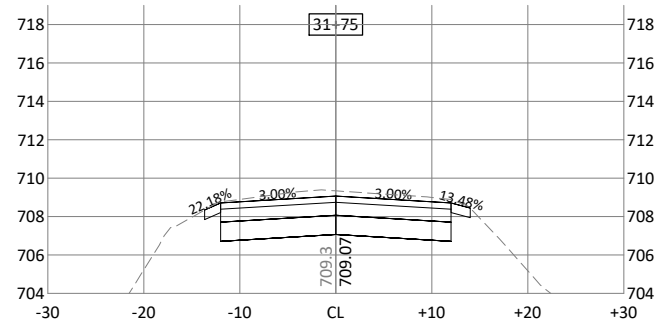
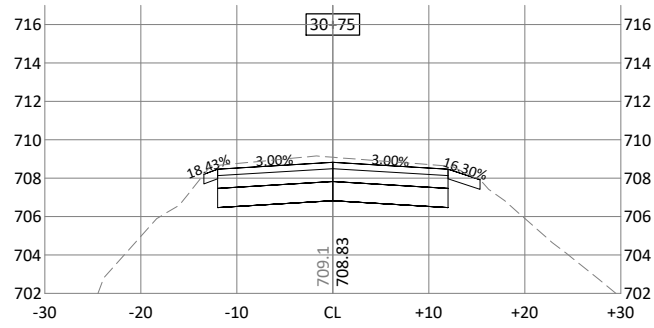
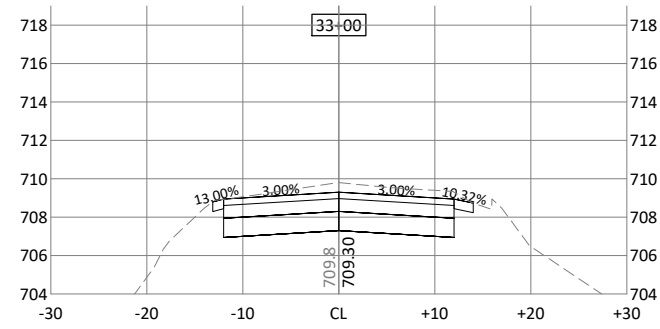
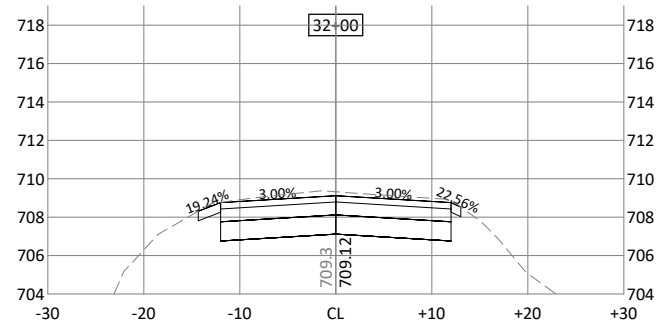
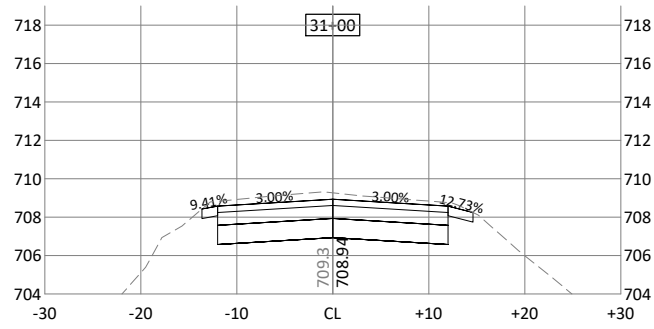
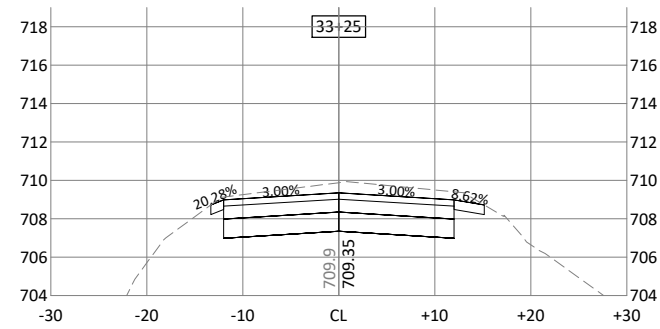
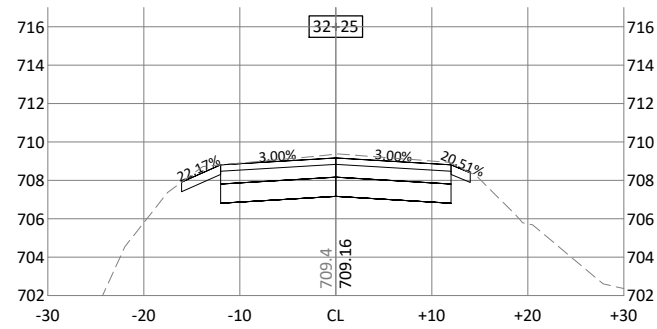
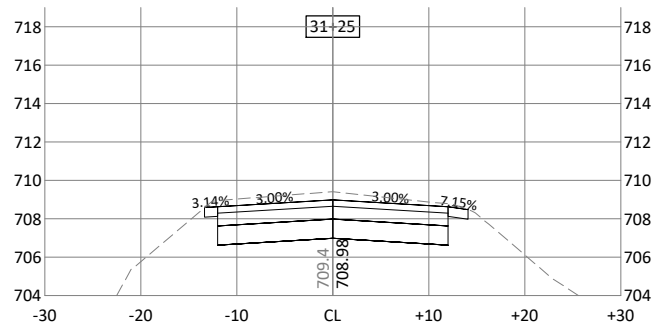
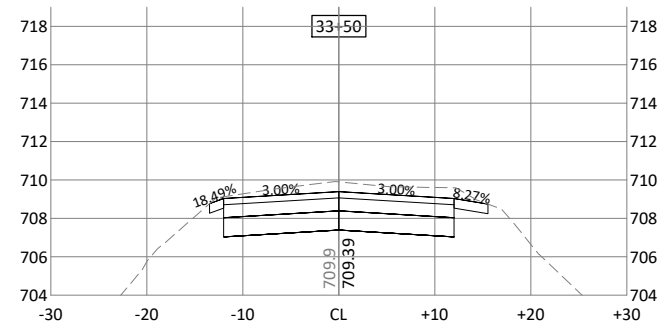
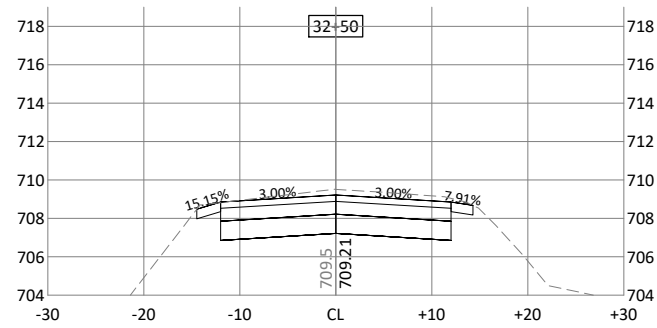
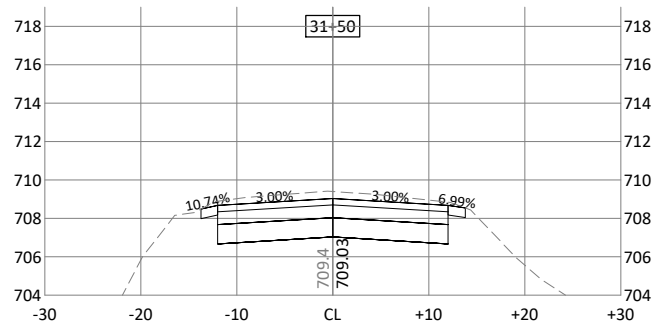

© Bolton & Menk, Inc. 2023. All Rights Reserved. PLANNING AND DESIGN SERVICES CONTRACT 129866-001.dwg 1/25/2024 4:17:20 PM

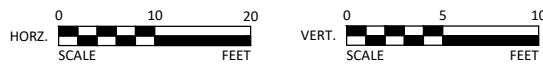

I HEREBY CERTIFY THAT THIS PLAN, SPECIFICATION, OR REPORT WAS PREPARED BY ME OR UNDER MY DIRECT SUPERVISION AND THAT I AM A DULY LICENSED PROFESSIONAL ENGINEER UNDER THE LAWS OF THE STATE OF MINNESOTA.

*Bradley J Fisher*  
 BRADLEY J FISHER  
 LIC. NO. 56595 DATE 02/21/2024



12224 NICOLLET AVENUE  
 BURNSVILLE, MINNESOTA 55337  
 Phone: (952) 890-0509  
 Email: Burnsville@bolton-menk.com  
 www.bolton-menk.com

DESIGNED	NO.	ISSUED FOR	DATE
JLW			
DRAWN	JLW		
CHECKED	BJF		
CLIENT PROJ. NO.	0T1.129866		

LOWER MINNESOTA RIVER WATERSHED DISTRICT  
 VERNON AVENUE IMPROVEMENTS  
 CROSS SECTIONS  
 VERNON AVENUE

SHEET  
**C8.11**

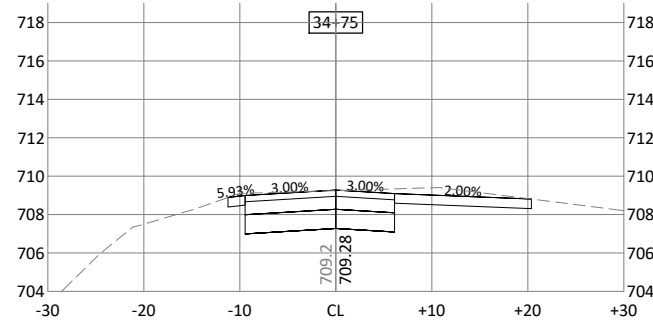
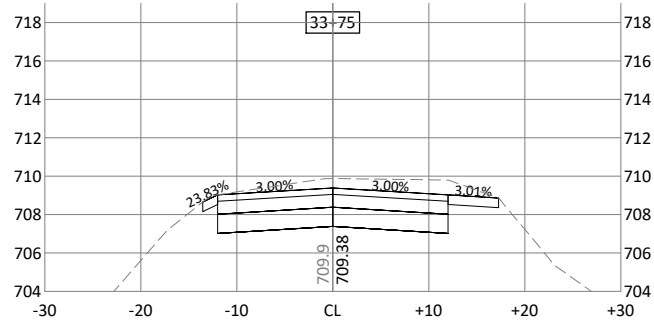
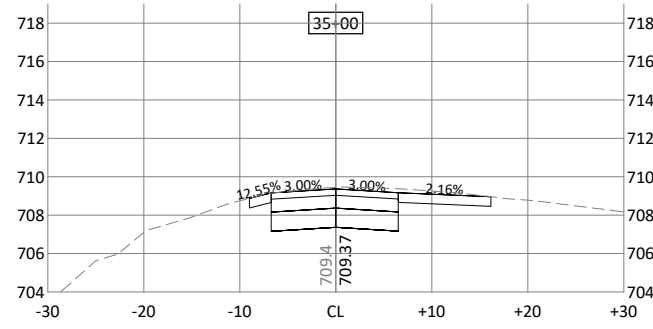
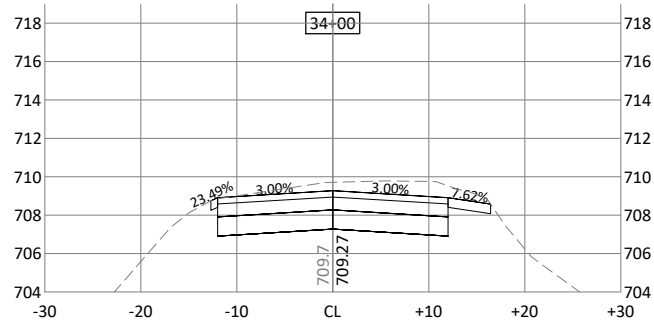
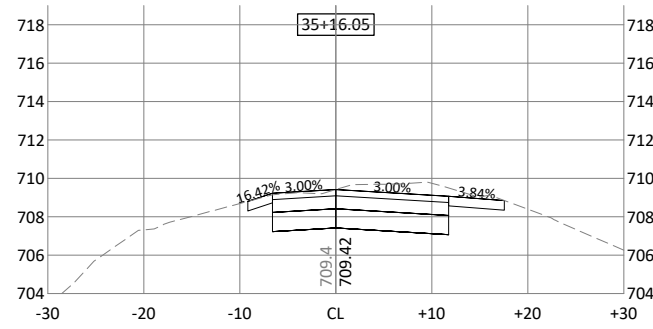
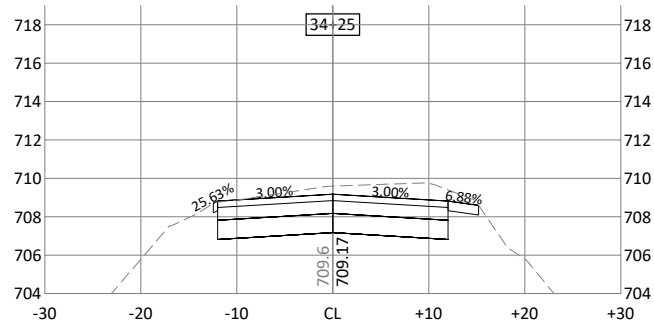
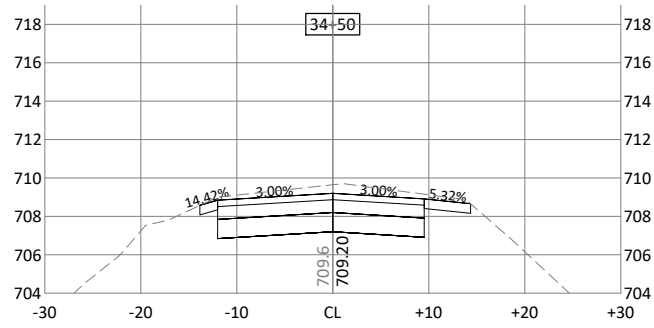

© Bolton & Menk, Inc. 2023. All Rights Reserved. P:\LOWMINN\1123865\CAD\CROSS\129866\CROSS1.dwg 1/25/2024 4:17:22 PM

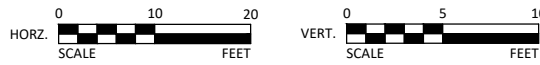

I HEREBY CERTIFY THAT THIS PLAN, SPECIFICATION, OR REPORT WAS PREPARED BY ME OR UNDER MY DIRECT SUPERVISION AND THAT I AM A DULY LICENSED PROFESSIONAL ENGINEER UNDER THE LAWS OF THE STATE OF MINNESOTA.

*Bradley J Fisher*  
 BRADLEY J FISHER  
 LIC. NO. 56595 DATE 02/21/2024



12224 NICOLLET AVENUE  
 BURNSVILLE, MINNESOTA 55337  
 Phone: (952) 890-0509  
 Email: Burnsville@bolton-menk.com  
 www.bolton-menk.com

DESIGNED	NO.	ISSUED FOR	DATE
JLW			
DRAWN			
JLW			
CHECKED			
BJF			
CLIENT PROJ. NO.			
011.129866			

LOWER MINNESOTA RIVER WATERSHED DISTRICT  
 VERNON AVENUE IMPROVEMENTS  
 CROSS SECTIONS  
 VERNON AVE N

SHEET  
**C8.12**

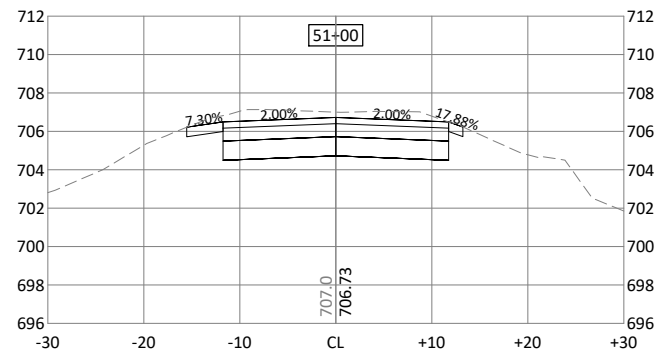
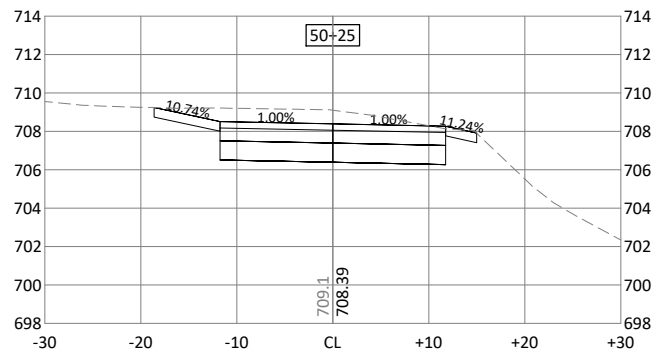
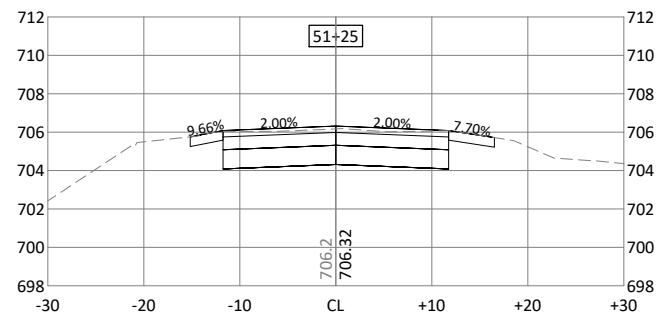
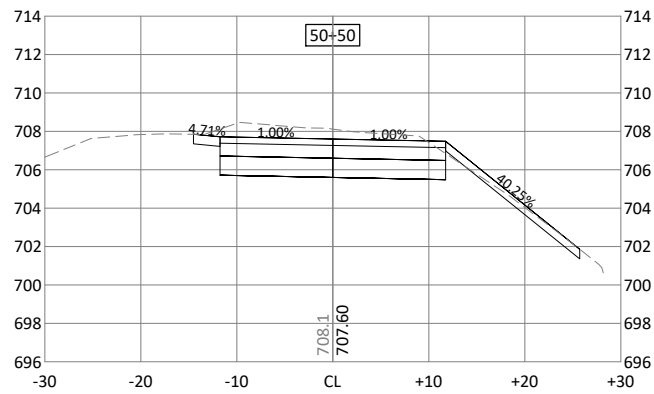
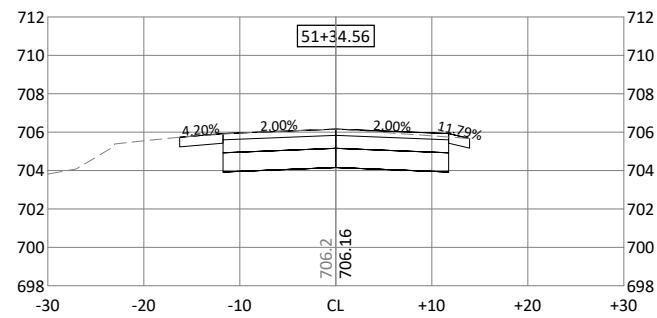
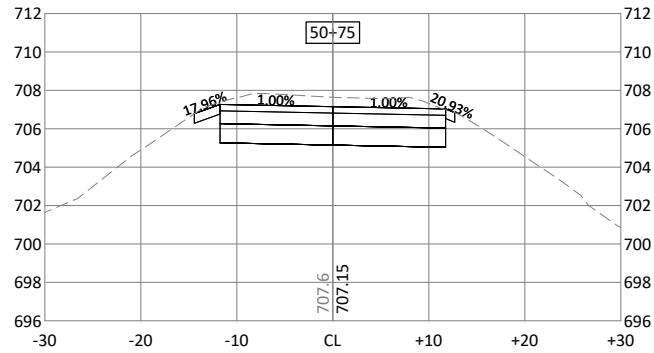

© Bolton & Menk, Inc. 2023. All Rights Reserved. PLU00129866.DWG 1/25/2024 4:17:23 PM



I HEREBY CERTIFY THAT THIS PLAN, SPECIFICATION, OR REPORT WAS PREPARED BY ME OR UNDER MY DIRECT SUPERVISION AND THAT I AM A DULY LICENSED PROFESSIONAL ENGINEER UNDER THE LAWS OF THE STATE OF MINNESOTA.

*Bradley J Fisher*  
 BRADLEY J FISHER  
 LIC. NO. 56595 DATE 02/21/2024



12224 NICOLLET AVENUE  
 BURNSVILLE, MINNESOTA 55337  
 Phone: (952) 890-0509  
 Email: Burnsville@bolton-menk.com  
 www.bolton-menk.com

DESIGNED	NO.	ISSUED FOR	DATE
JLW			
DRAWN			
JLW			
CHECKED			
BJF			
CLIENT PROJ. NO.			
011.129866			

LOWER MINNESOTA RIVER WATERSHED DISTRICT  
 VERNON AVENUE IMPROVEMENTS  
 CROSS SECTIONS  
 DREDGE SITE ACCESS ROAD

SHEET  
**C8.13**

**ENGINEER'S ESTIMATE**

LOWER MINNESOTA RIVER WATERSHED DISTRICT

VERNON AVENUE IMPROVEMENTS

CITY OF SAVAGE, MINNESOTA

BMI PROJECT NO. OT1.129866

**SCHEDULE "A" - BASE BID**

ITEM NO.	SPEC. REF	DESCRIPTION	NOTES	UNIT	TOTAL ESTIMATED QUANTITY	ESTIMATED UNIT PRICE	ESTIMATED TOTAL PRICE
1	2021.501	MOBILIZATION		LUMP SUM	1.00	\$30,000.00	\$ 30,000.00
2	2101.502	CLEARING		EACH	48.00	\$400.00	\$ 19,200.00
3	2101.502	GRUBBING		EACH	48.00	\$300.00	\$ 14,400.00
4	2104.502	SALVAGE SIGN		EACH	1.00	\$60.00	\$ 60.00
5	2104.503	SAWING BITUMINOUS PAVEMENT (FULL DEPTH)		LIN FT	26.00	\$4.00	\$ 104.00
6	2104.503	REMOVE SEWER PIPE (STORM)	(1)	LIN FT	96.00	\$30.00	\$ 2,880.00
7	2104.504	REMOVE BITUMINOUS PAVEMENT	(P)(2)	SQ YD	9320.00	\$3.50	\$ 32,620.00
8	2104.507	REMOVE RIPRAP	(EV)	CU YD	40.00	\$60.00	\$ 2,400.00
9	2106.507	EXCAVATION - COMMON	(EV)(P)	CU YD	6358.00	\$15.00	\$ 95,370.00
10	2106.507	EXCAVATION - SUBGRADE	(EV)(3)	CU YD	262.00	\$16.00	\$ 4,192.00
11	2106.507	SELECT GRANULAR EMBANKMENT	(CV)(P)	CU YD	3366.00	\$25.00	\$ 84,150.00
12	2106.507	STABILIZING AGGREGATE	(CV)(3)	CU YD	262.00	\$35.00	\$ 9,170.00
13	2106.601	DEWATERING	(4)	LUMP SUM	1.00	\$5,000.00	\$ 5,000.00
14	2106.603	MINOR GRADING	(5)	LIN FT	80.00	\$50.00	\$ 4,000.00
15	2118.507	AGGREGATE SURFACING CLASS 2	(CV)(P)	CU YD	188.00	\$62.00	\$ 11,656.00
16	2123.510	COMMON LABORERS	(3)	HOUR	15.00	\$90.00	\$ 1,350.00
17	2123.510	DOZER	(3)	HOUR	5.00	\$200.00	\$ 1,000.00
18	2123.610	CRAWLER MOUNTED BACKHOE	(3)	HOUR	5.00	\$220.00	\$ 1,100.00
19	2211.507	AGGREGATE BASE CLASS 5	(CV)(P)	CU YD	2244.00	\$35.00	\$ 78,540.00
20	2357.506	BITUMINOUS MATERIAL FOR TACK COAT		GAL	550.00	\$2.50	\$ 1,375.00
21	2360.509	TYPE SP 9.5 WEARING COURSE MIXTURE (3,C)		TON	1848.00	\$85.00	\$ 157,080.00
22	2501.502	48" RC PIPE APRON	(6)(7)	EACH	2.00	\$3,250.00	\$ 6,500.00
23	2503.503	48" RC PIPE SEWER CLASS III	(7)	LIN FT	84.00	\$300.00	\$ 25,200.00
24	2511.507	RANDOM RIPRAP CLASS III	(8)	CU YD	80.00	\$85.00	\$ 6,800.00
25	2563.601	TRAFFIC CONTROL		LUMP SUM	1.00	\$5,000.00	\$ 5,000.00
26	2563.621	TRAFFIC CONTROL SPECIAL (RR FLAGGING)		DOL	15000.00	\$1.00	\$ 15,000.00
27	2564.602	INSTALL SIGN	(9)	EACH	1.00	\$200.00	\$ 200.00
28	2572.602	TREE PRUNING	(3)	HOUR	12.00	\$200.00	\$ 2,400.00
29	2573.501	STABILIZED CONSTRUCTION EXIT		LUMP SUM	1.00	\$1,500.00	\$ 1,500.00
30	2573.502	STORM DRAIN INLET PROTECTION		EACH	3.00	\$200.00	\$ 600.00
31	2573.503	FLOTATION SILT CURTAIN TYPE STILL WATER		LIN FT	40.00	\$20.00	\$ 800.00
32	2573.503	SEDIMENT CONTROL LOG TYPE WOOD FIBER		LIN FT	14000.00	\$3.75	\$ 52,500.00
33	2574.507	COMMON TOPSOIL BORROW	(LV)	CU YD	1426.00	\$30.00	\$ 42,780.00
34	2575.504	ROLLED EROSION PREVENTION CATEGORY 20 W/ SEED MIX (25-141)	(10)	SQ YD	8295.00	\$3.00	\$ 24,885.00
35	2575.504	ROLLED EROSION PREVENTION CATEGORY 20 W/ SEED MIX (34-181)	(10)	SQ YD	257.00	\$3.00	\$ 771.00
<b>ESTIMATED CONSTRUCTION SUBTOTAL</b>							<b>\$ 740,583.00</b>
<b>10% CONTINGENCY</b>							<b>\$ 74,058.30</b>
<b>ESTIMATED CONSTRUCTION TOTAL</b>							<b>\$ 814,641.30</b>
<b>20% OVERHEAD</b>							<b>\$ 162,928.26</b>
<b>ESTIMATED PROJECT TOTAL</b>							<b>\$ 977,569.56</b>